

D MONTAGEANLEITUNG
BEDIENUNGSANLEITUNG

NL HANDLEIDING VOOR DE MONTAGE
GEBRUIKSAANWIJZING

TR MONTAJ TALIMATI
KULLANIM KLAVUZU

RO INSTRUCȚIUNI DE INSTALARE
INSTRUCȚIUNI DE UTILIZARE

FR NOTICE DE MONTAGE
MANUEL INSTRUCTIONS

HU KÖZGYŰLÉS UTASÍTÁSOK
KEZELÉSI UTASÍTÁS

SI NAVODILA ZA MONTAŽO
NAVODILA ZA UPORABO

ES INSTRUCCIONES DE MONTAJE
MANUAL DEL USUARIO

GB ASSEMBLY INSTRUCTIONS
INSTRUCTION MANUAL

PL INSTRUKCJA MONTAŻU
INSTRUKCJA OBSŁUGI

RU ИНСТРУКЦИЯ ПО МОНТАЖУ
ИНСТРУКЦИЯ ПО ЭКСПЛУАТАЦИИ

IT ISTRUZIONI DI MONTAGGIO
MANUALE DI ISTRUZIONI

SK MONTÁŽNY NÁVOD
NÁVOD NA POUŽITIE

CZ MONTÁŽNÍ NÁVOD
NÁVOD K POUŽITÍ

PT INSTRUÇÕES DE MONTAGEM
MANUAL DO USUÁRIO

HR UPUTE ZA MONTAŽU
UPUTE ZA UPOTREBU

DOVER
VITO TICONA
TRENDY, SEATTLE
ALPHA, BETA, OHIO, POLO

12.08.2024

Service · Dienstverlening · Serwis · Servis · Сервисная служба · Serviciu · Services · Servizio · Servisný list · Szolgáltatás · Servisní list

Name · Naam · Nazwa · İsim · Название · Nume · Nome ·
Názov · Název · Název · Neve

Тур · Type · Tip · Тип · Tipo · Típus

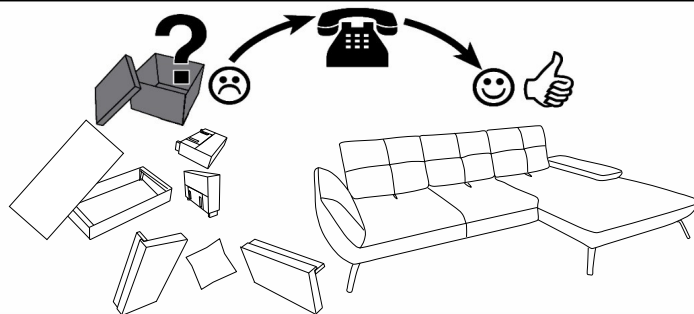
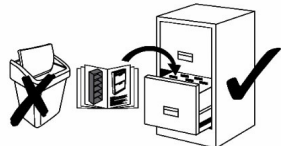





✓		 A a1	 B M6x25	 C	 D L4	 E 5L M8x30 e1	
			4 x A 4 x a1	16x	/	1x	/
	 2er		4 x A 4 x a1	16x	1x		/
	 3er		4 x A 4 x a1	16x	2x		/
			4 x A 4 x a1	16x	2x		/
	 MEGASOFA		4 x A 4 x a1	16x	1x		1 x E 1 x e1
			4 x A 4 x a1	16x	2x		/

Service · Dienstverlening · Serwis · Servis · Сервисная служба · Serviciu · Services · Servizio · Servisný list · Szolgáltatás · Servisní list

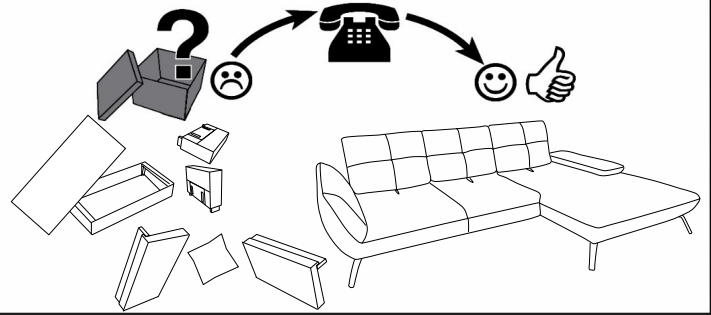
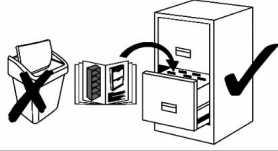
Name · Naam · Nazwa · İsim · Название · Nume · Nome ·
Názov · Názov · Název · Neve

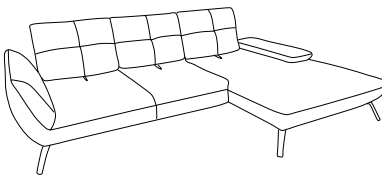
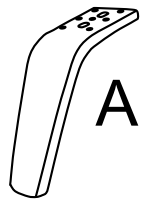
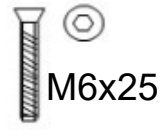
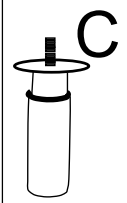
Тип · Type · Tip · Тип · Tipo · Típus

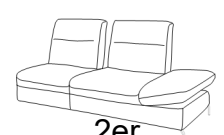
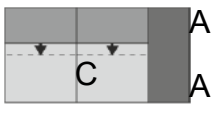
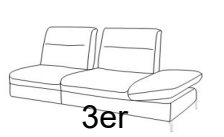
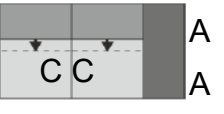

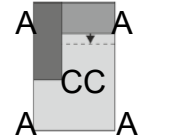
✓		 A a1	 B M6x25	 C	 D L4
	 2er	 A C A	2 x A 2 x a1	8x	1x
	 3er	 A C C A	2 x A 2 x a1	8x	2x
		 A A C C A A	4 x A 4 x a1	16x	2x

2er

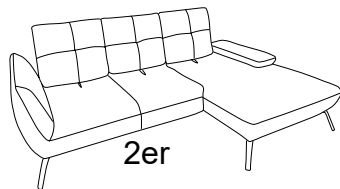

2er

3er

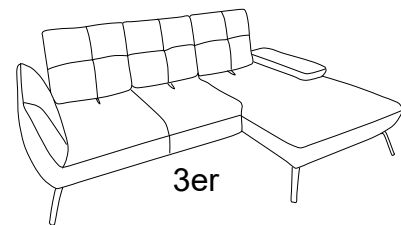

3er

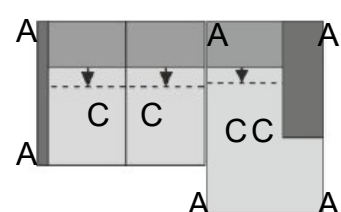
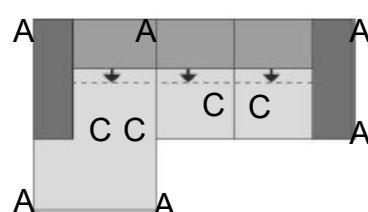
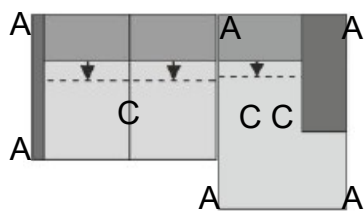
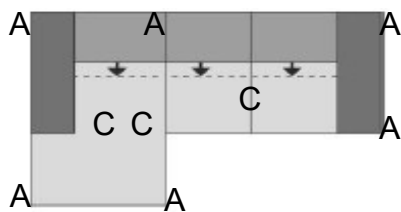







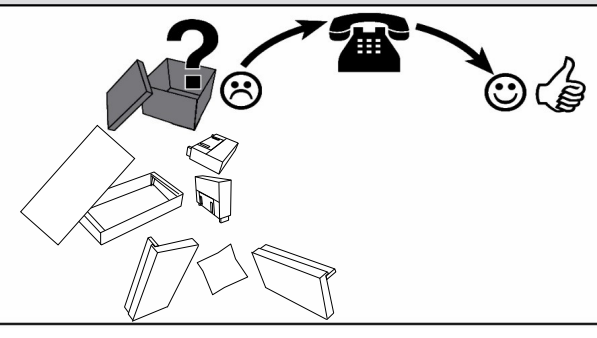
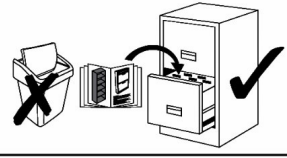

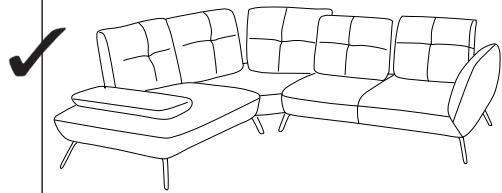
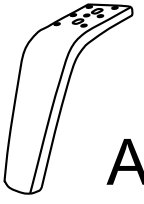

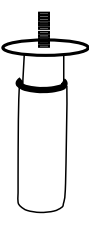

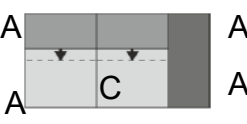
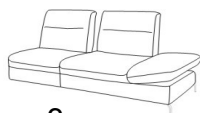
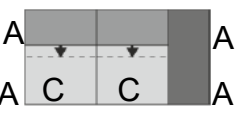

Service · Dienstverlening · Serwis · Servis · Сервисная служба · Serviciu · Services · Servizio · Servisný list · Szolgáltatás · Servisní list

Name · Naam · Nazwa · İsim · Название · Nume · Nome ·
Názov · Náзов · Název · Neve

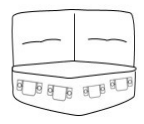
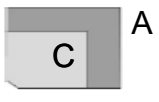
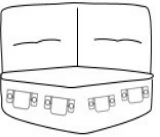
Тур · Туре · Tip · Тип · Тiро · Típus



	 A a1	 B M6x25	 C	 D 4L	 E 5L	 F M8	 G M8x30	
 2er		4 x A 4 x a1	16x	1x				
 3er		4 x A 4 x a1	16x	2x				
		4 x A 4 x a1	16x	/				
		1 x A 1 x a1	4x	1x	1x	1x	4x	4x
		3 x A 3 x a1	3x4	1x	1x	1x	8x	8x
		4xA 4xa1	16x	1x				

C

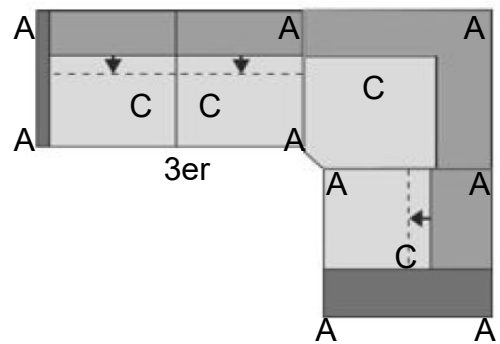
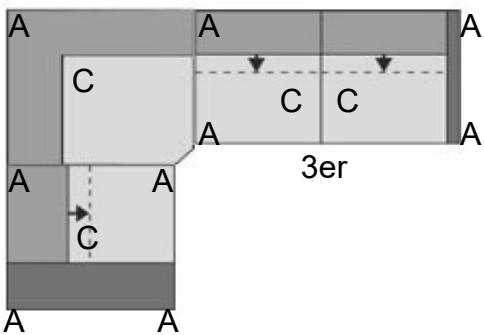
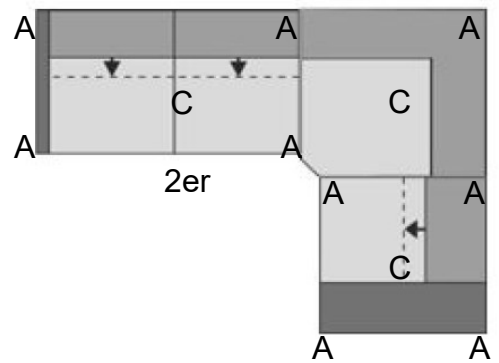
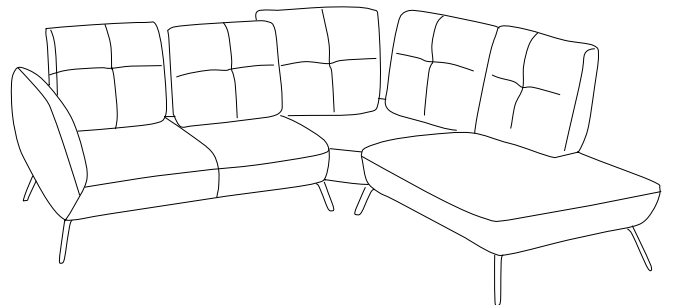
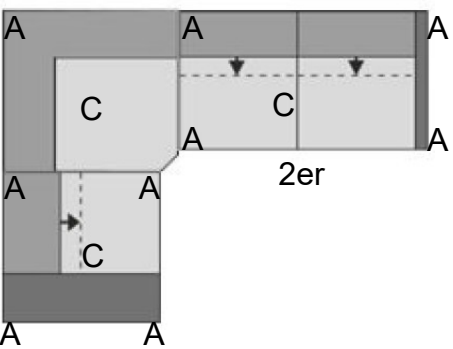
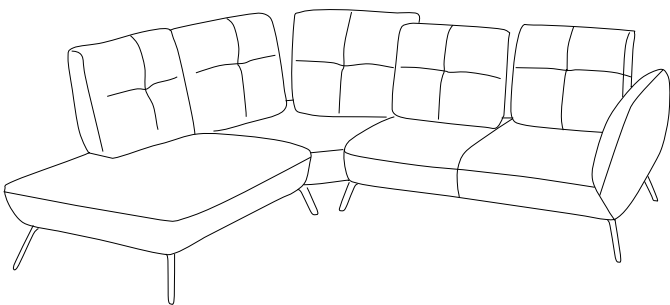
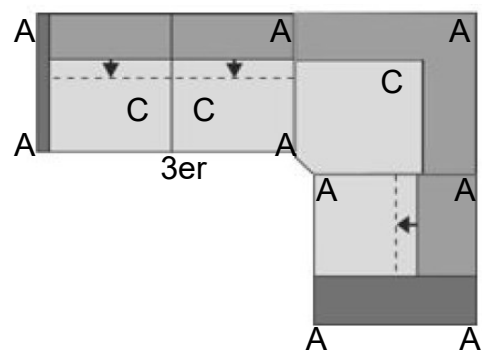
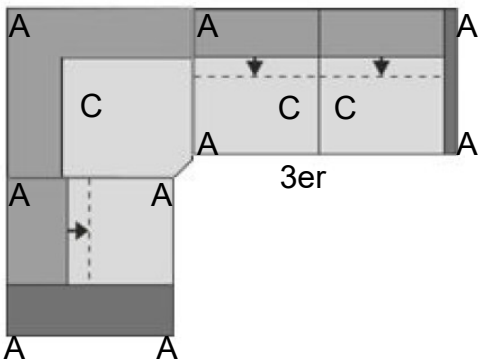
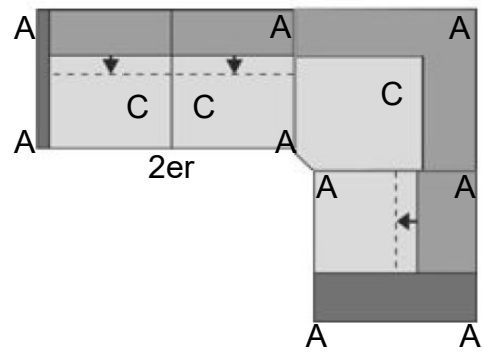
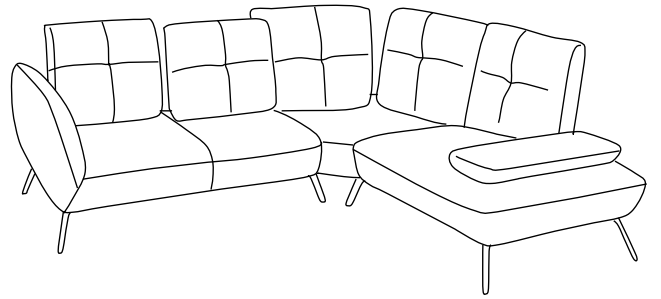
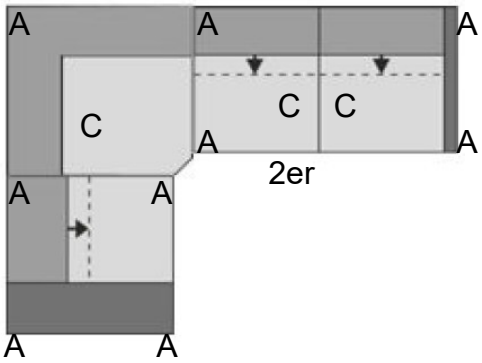
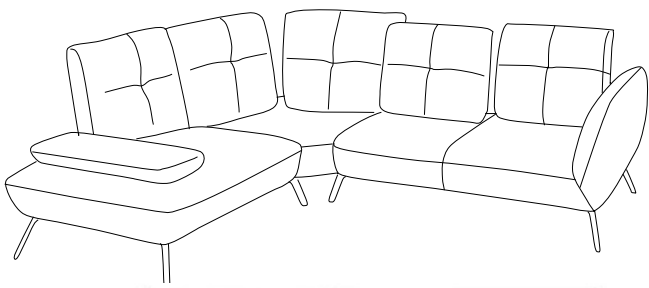







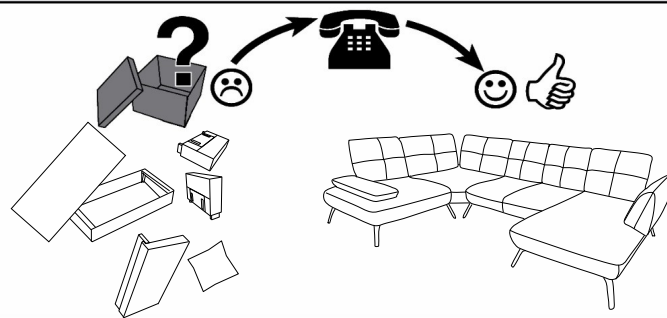
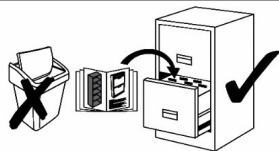

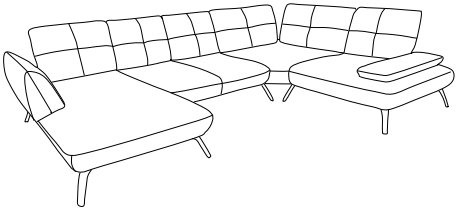

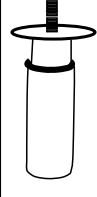



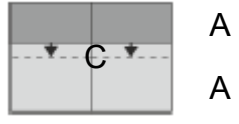

Service · Dienstverlening · Serwis · Servis · Сервисная служба · Serviciu ·
Services · Servizio · Servisný list · Szolgáltatás · Servisní list

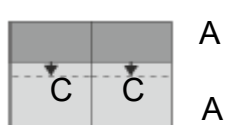
Name · Naam · Nazwa · İsim · Название · Nume · Nome ·
Názov · Názov · Název · Neve

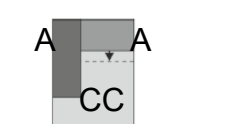
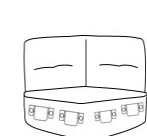
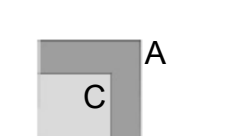
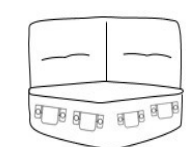
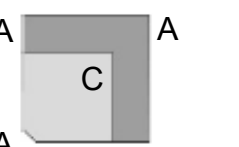
Тип · Type · Tip · Тип · Tipo · Típus

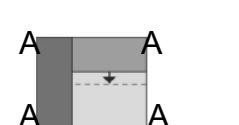

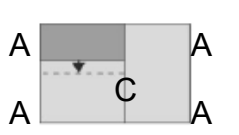
		 A a1	 B M6x25	 C	 D 4L	 E 5L	 F M8	 G M8x30
 2er	 A A	2xA 2xa1	8x	1x				
 3er	 A A	2xA 2xa1	8x	2x				
	 A A CC A	4xA 4xa1	16x	2x				
	 A C	1xA 1xa1	4x	1x	1x	1x	4x	4x
	 A A C A	3xA 3xa1	3x4	1x	1x	1x	8x	8x
	 A A A A	4xA 4xa1	16x	/				
	 A A C A	4xA 4xa1	16x	1x				

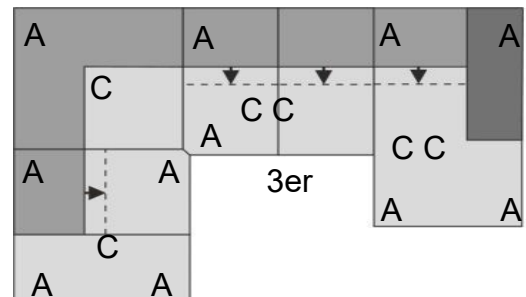
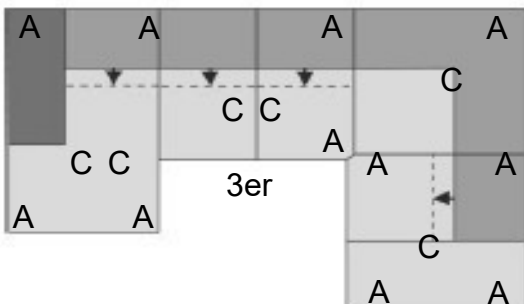
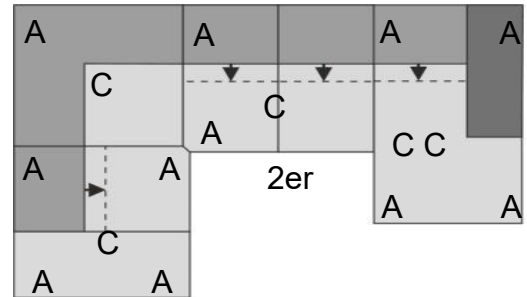
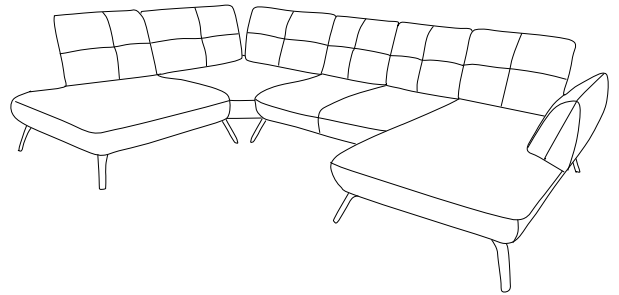
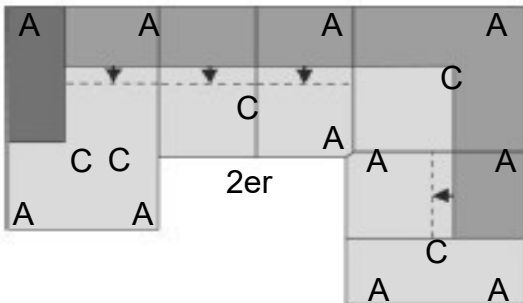
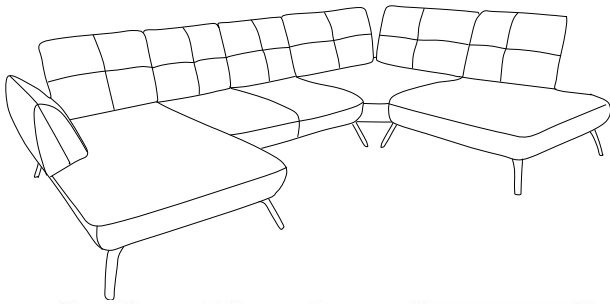
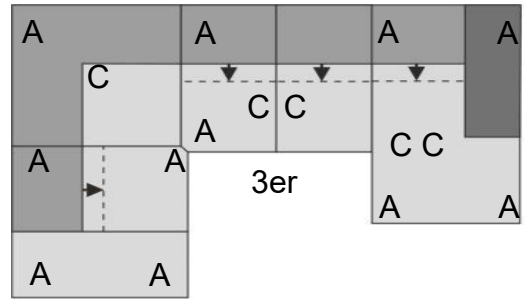
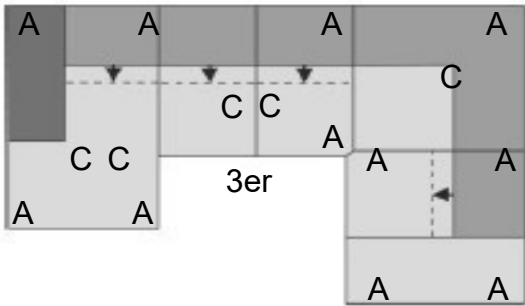
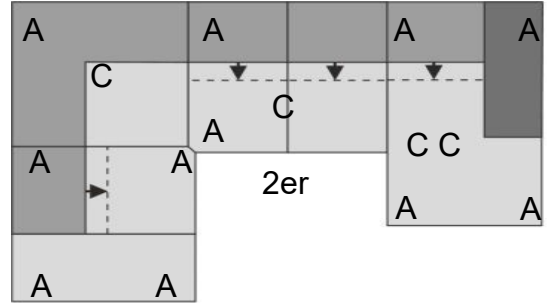
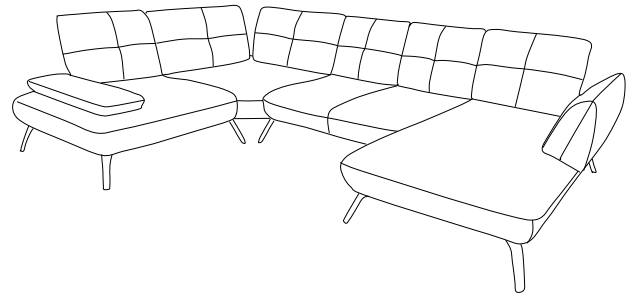
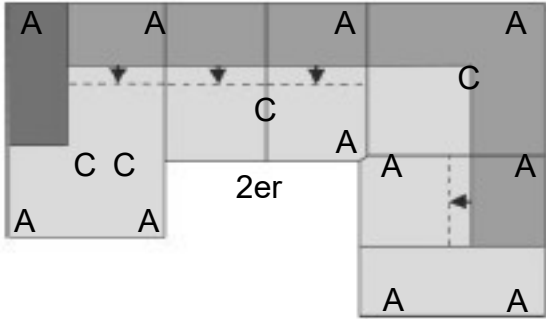
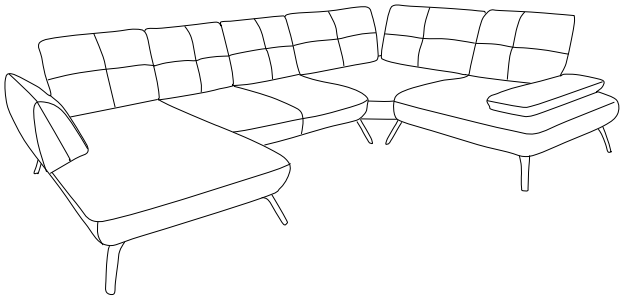

1

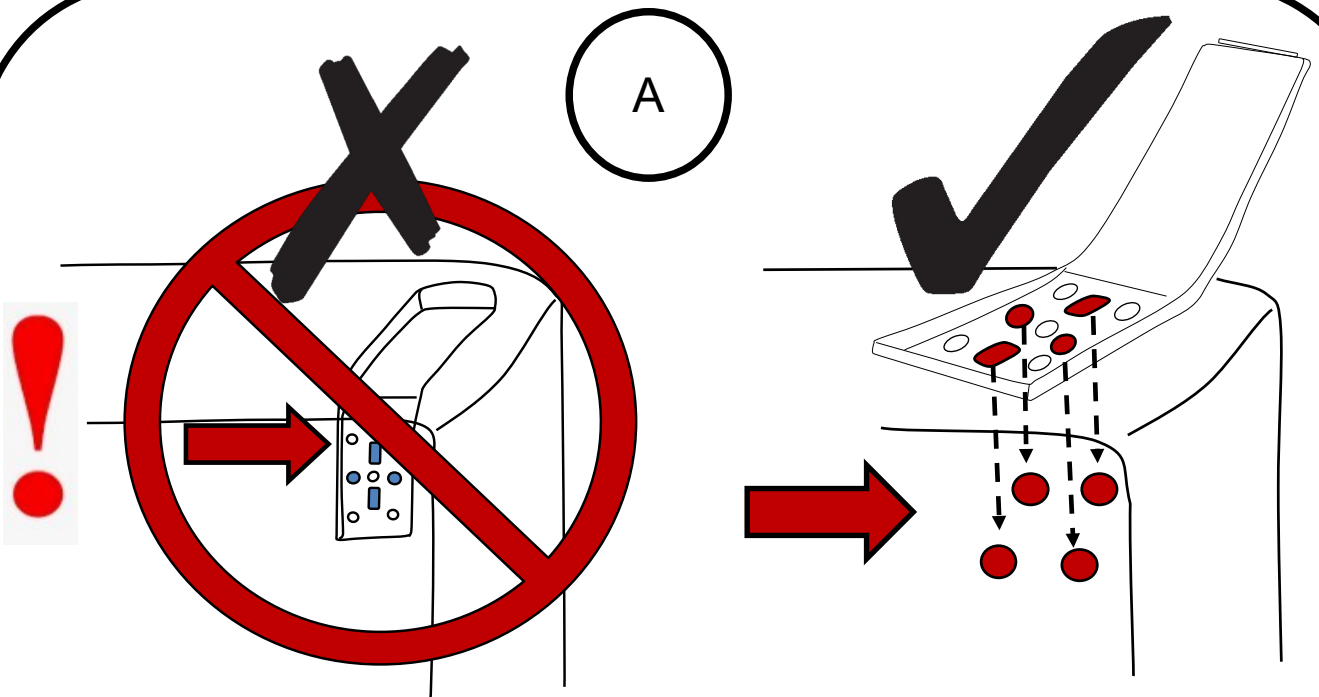
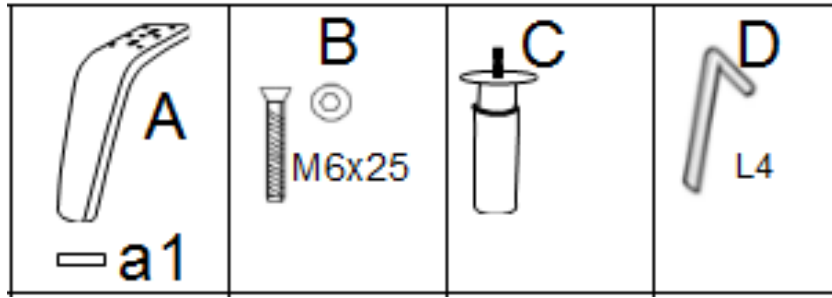
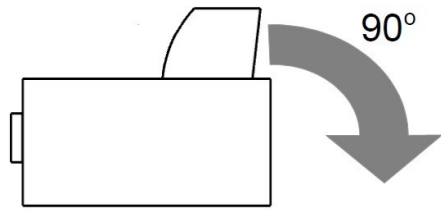

2

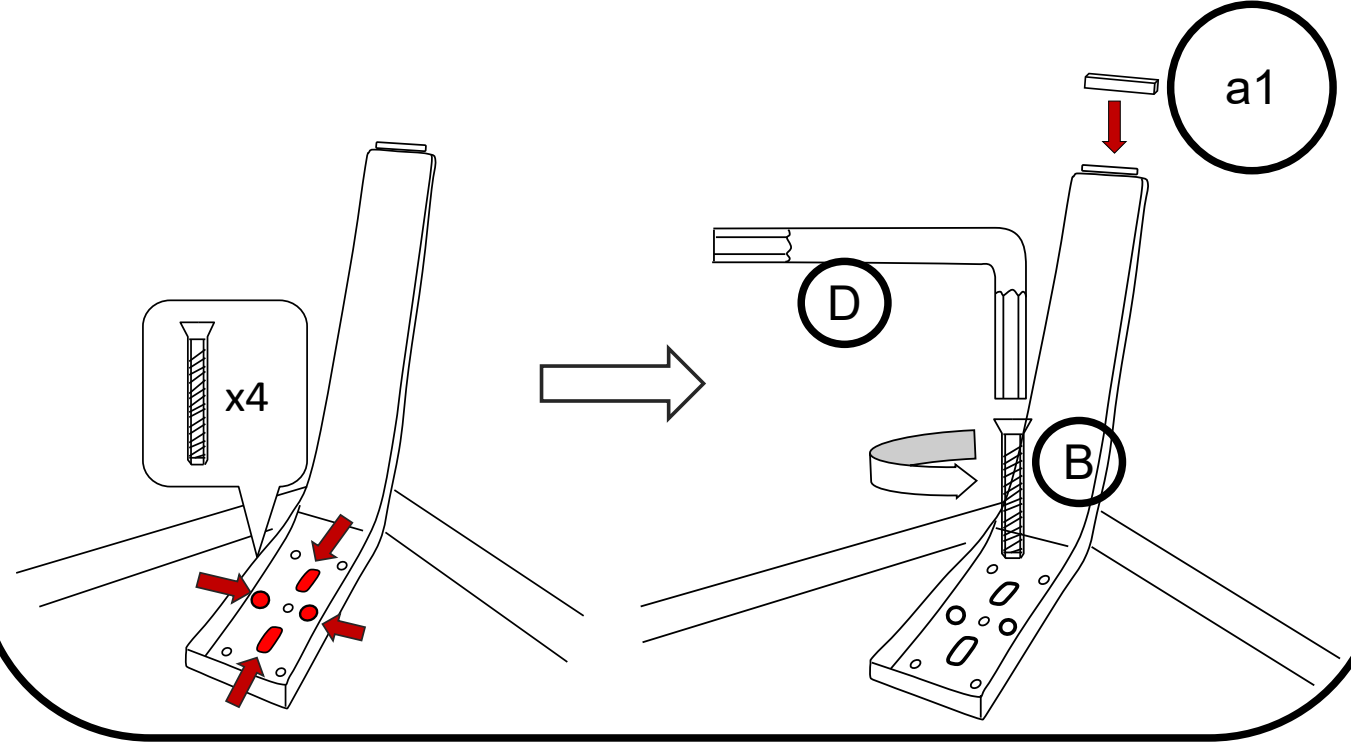

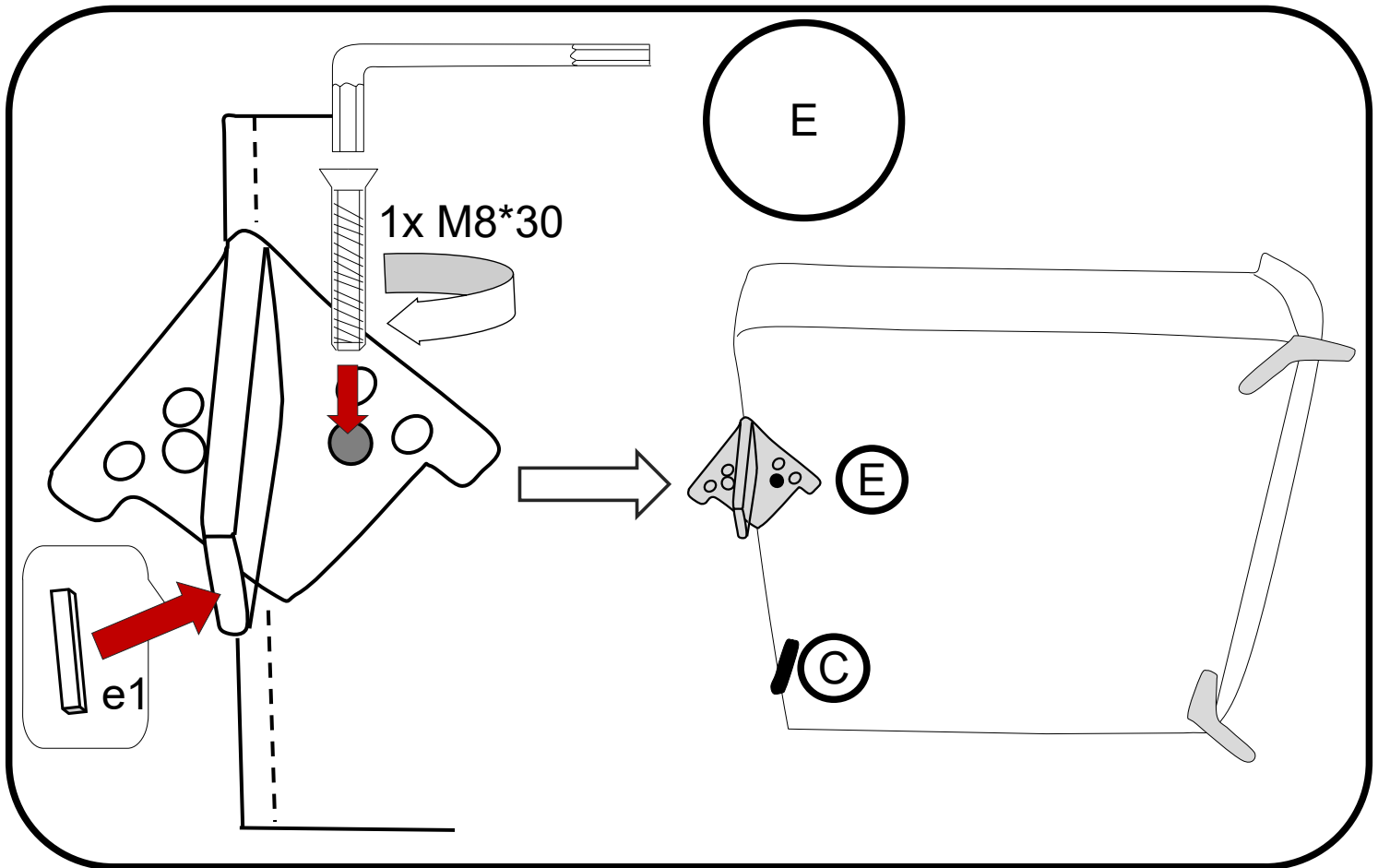
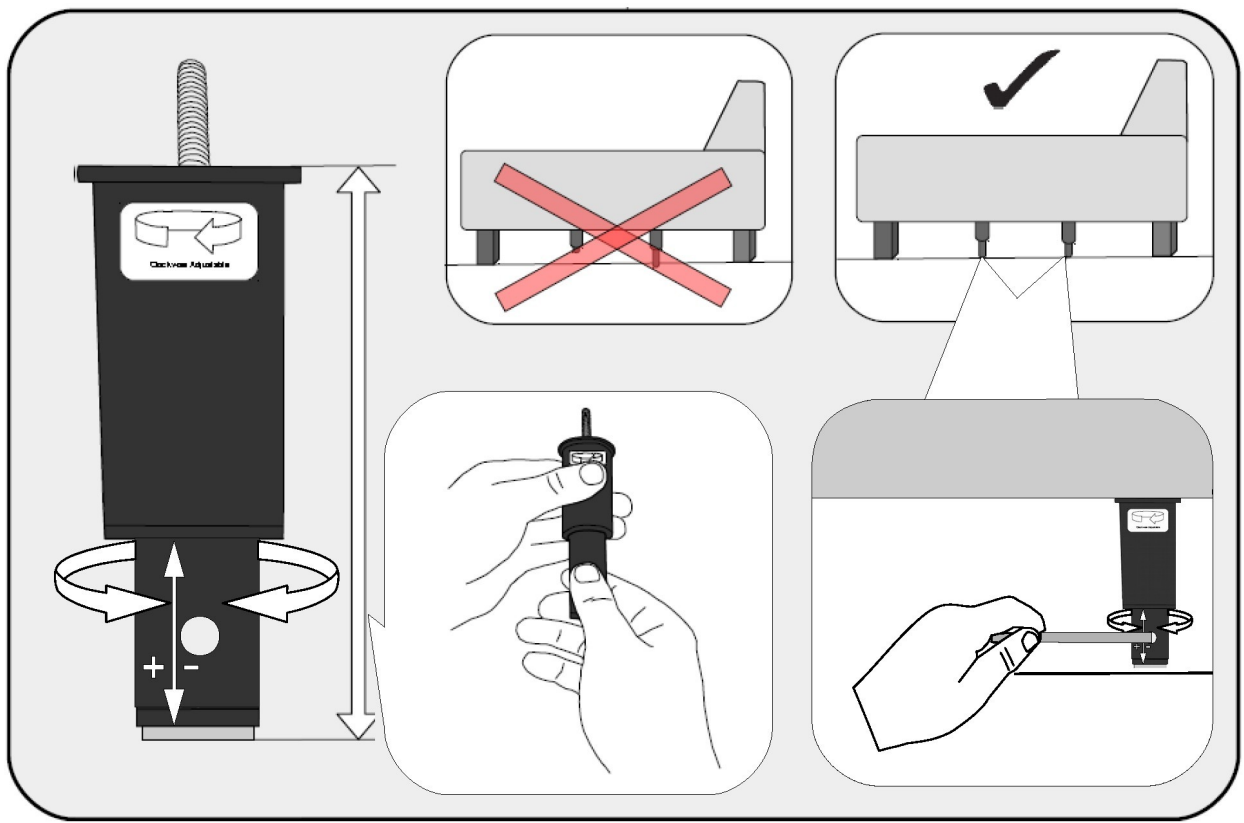

3

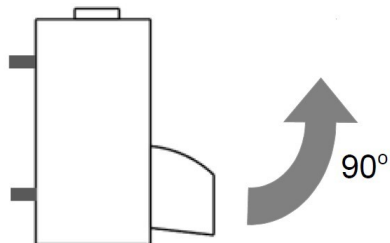

9

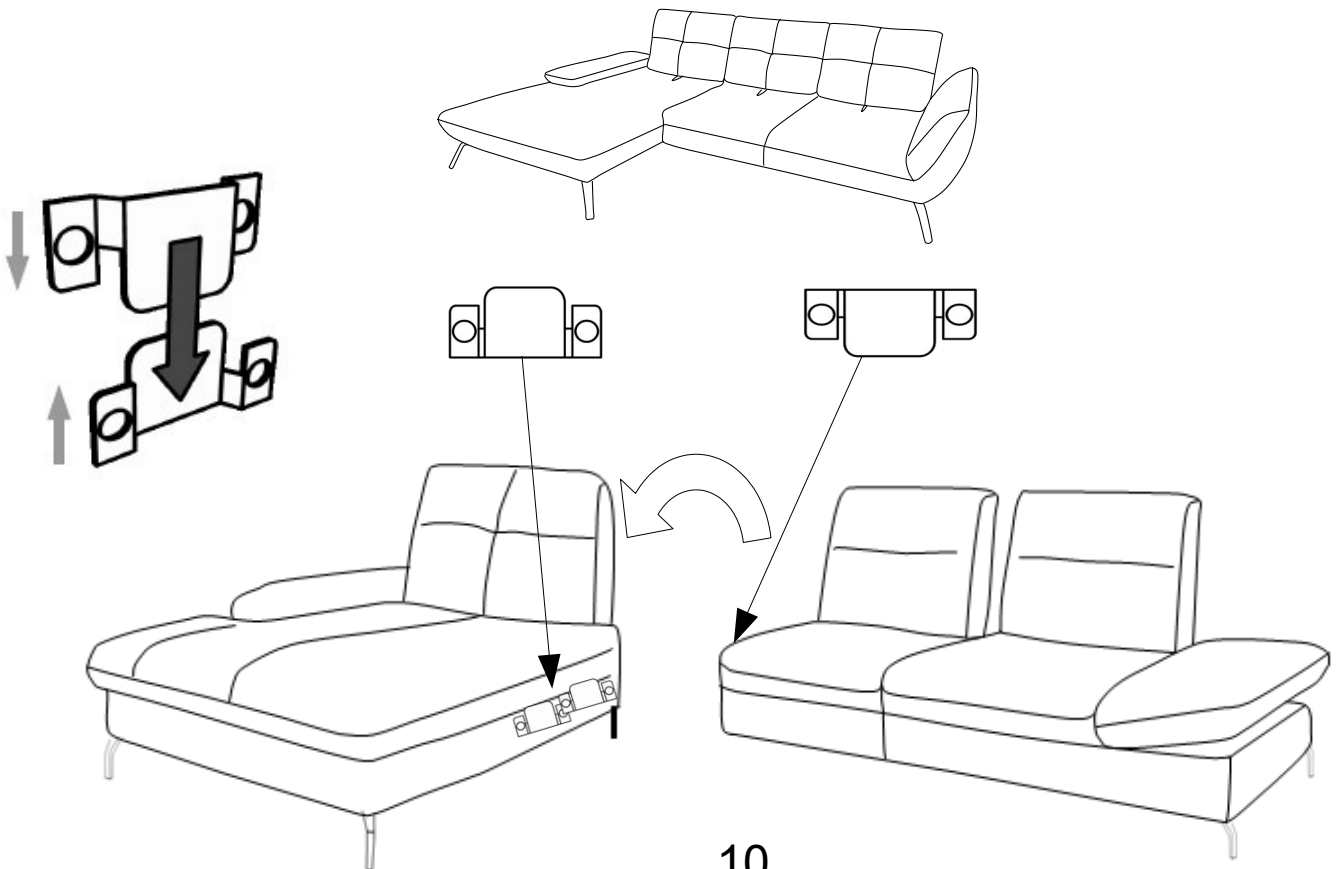
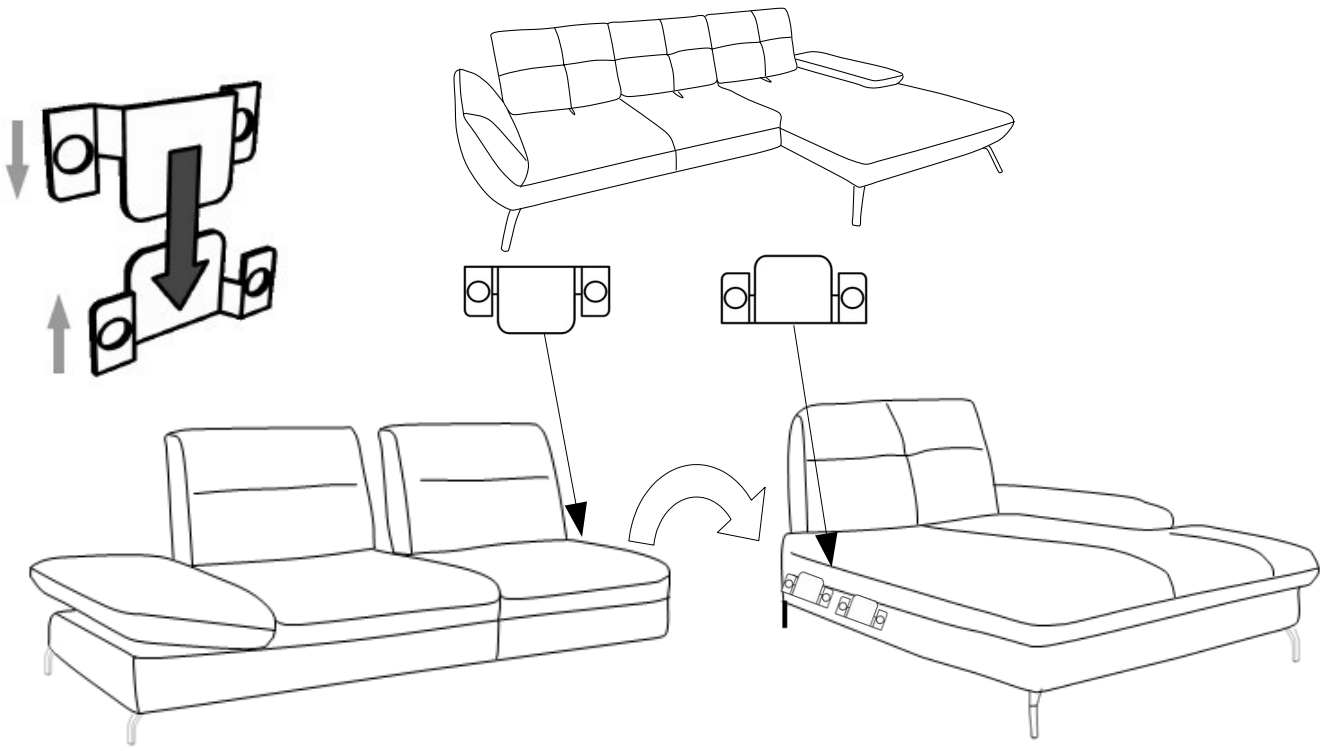

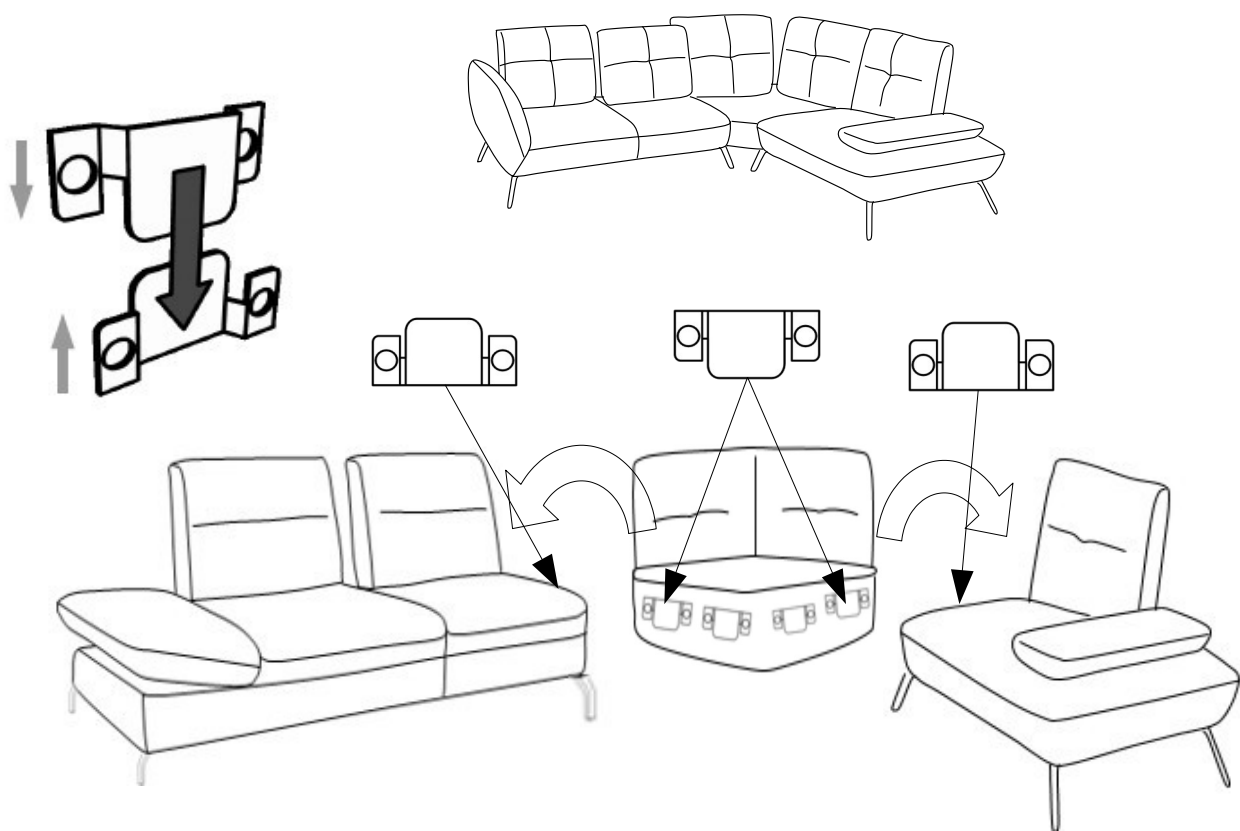
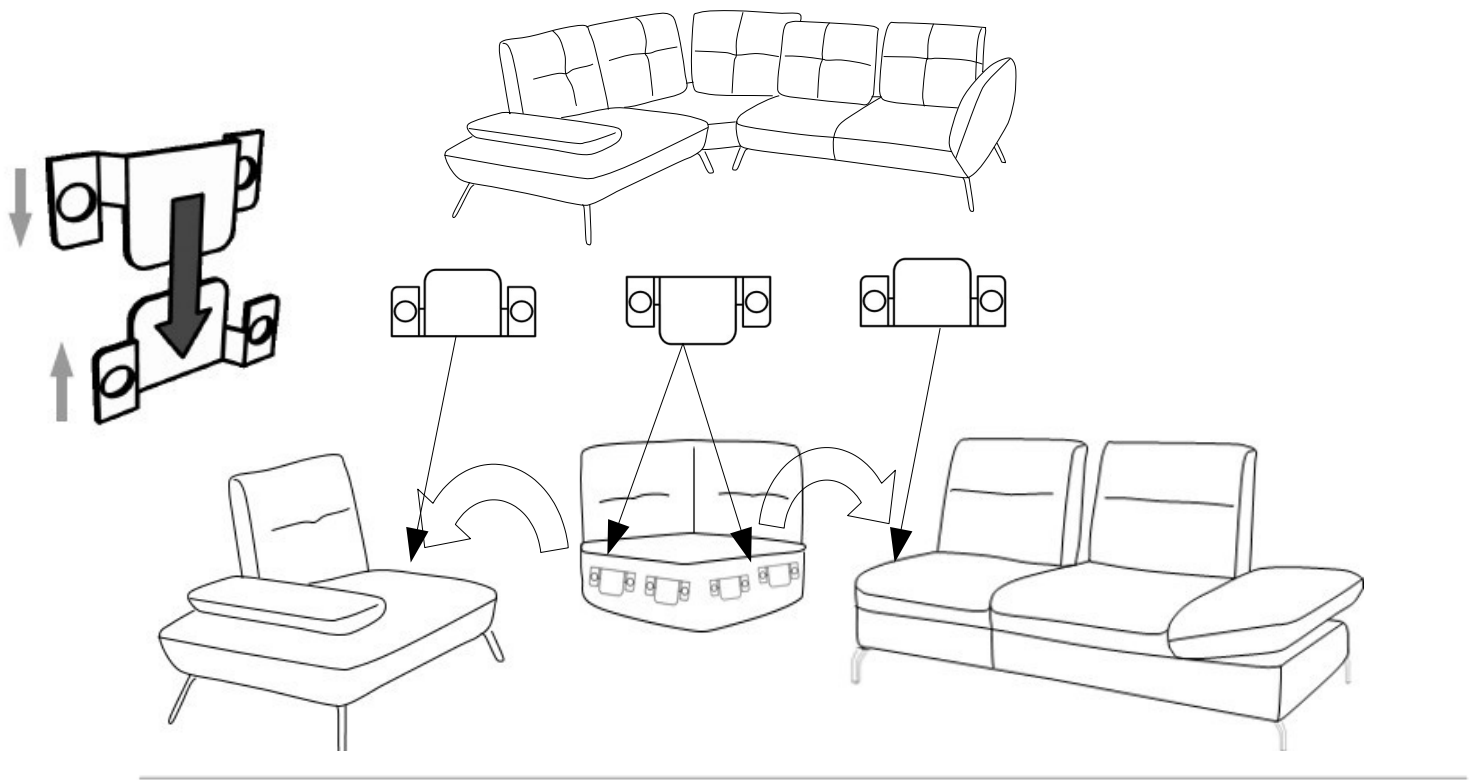

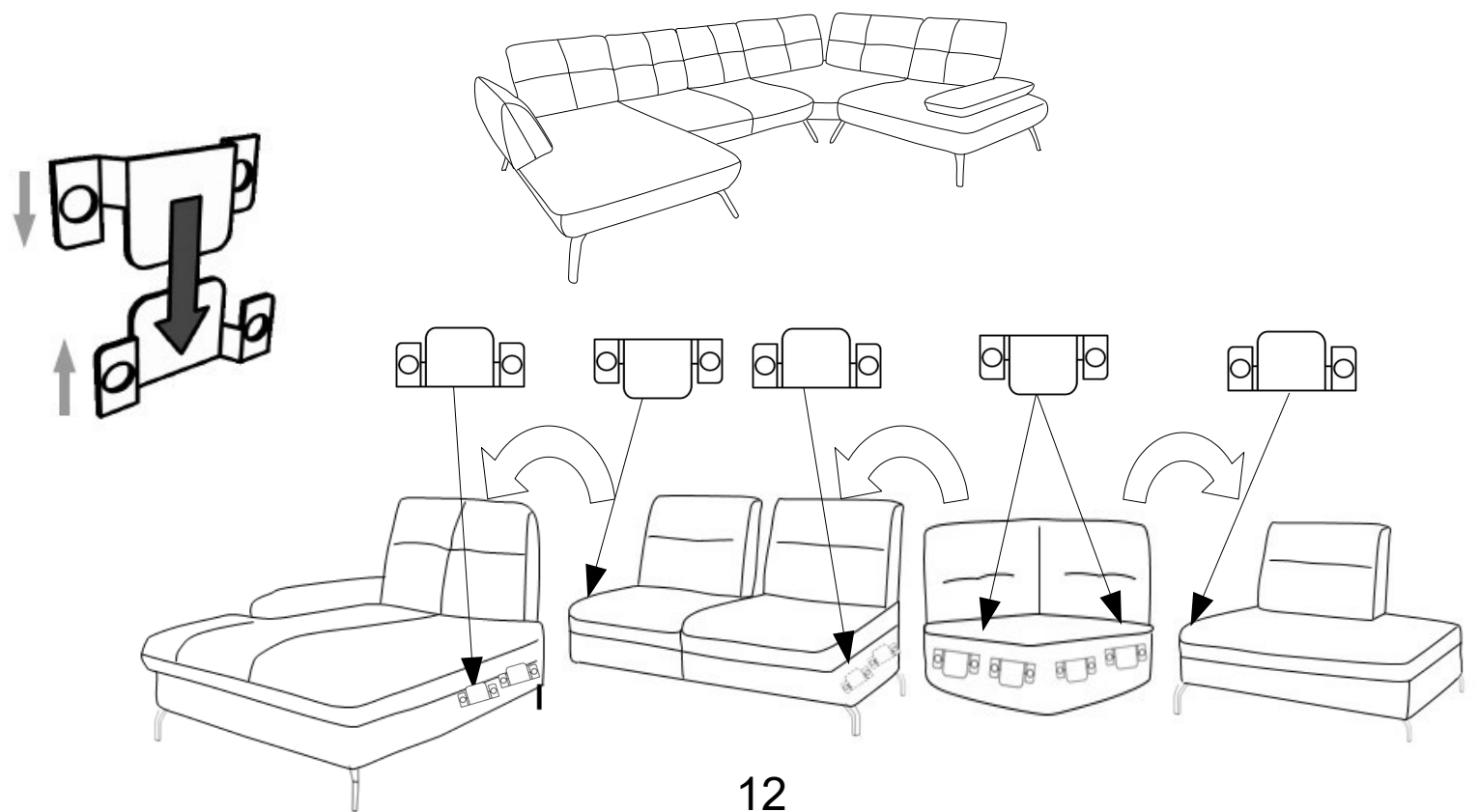
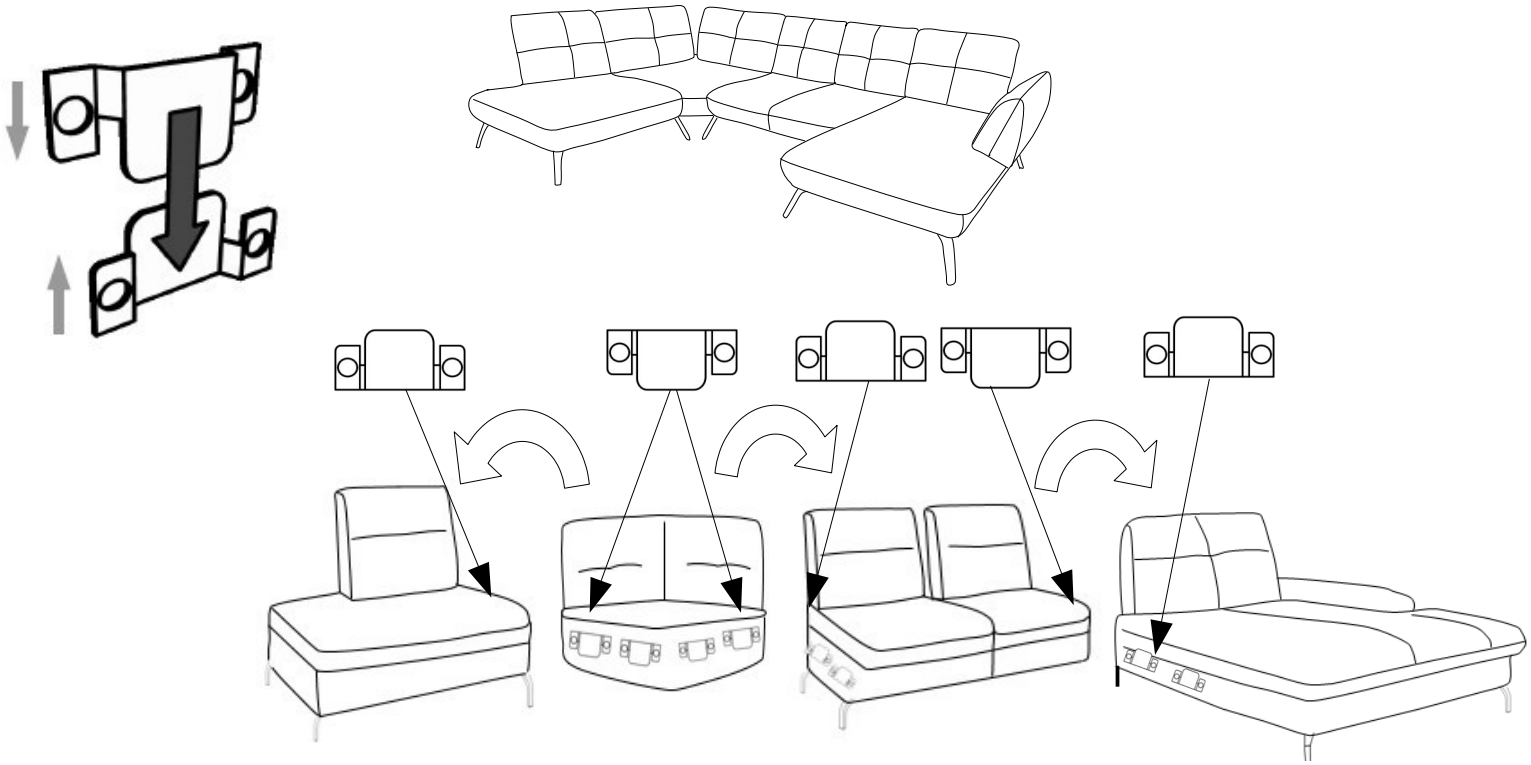

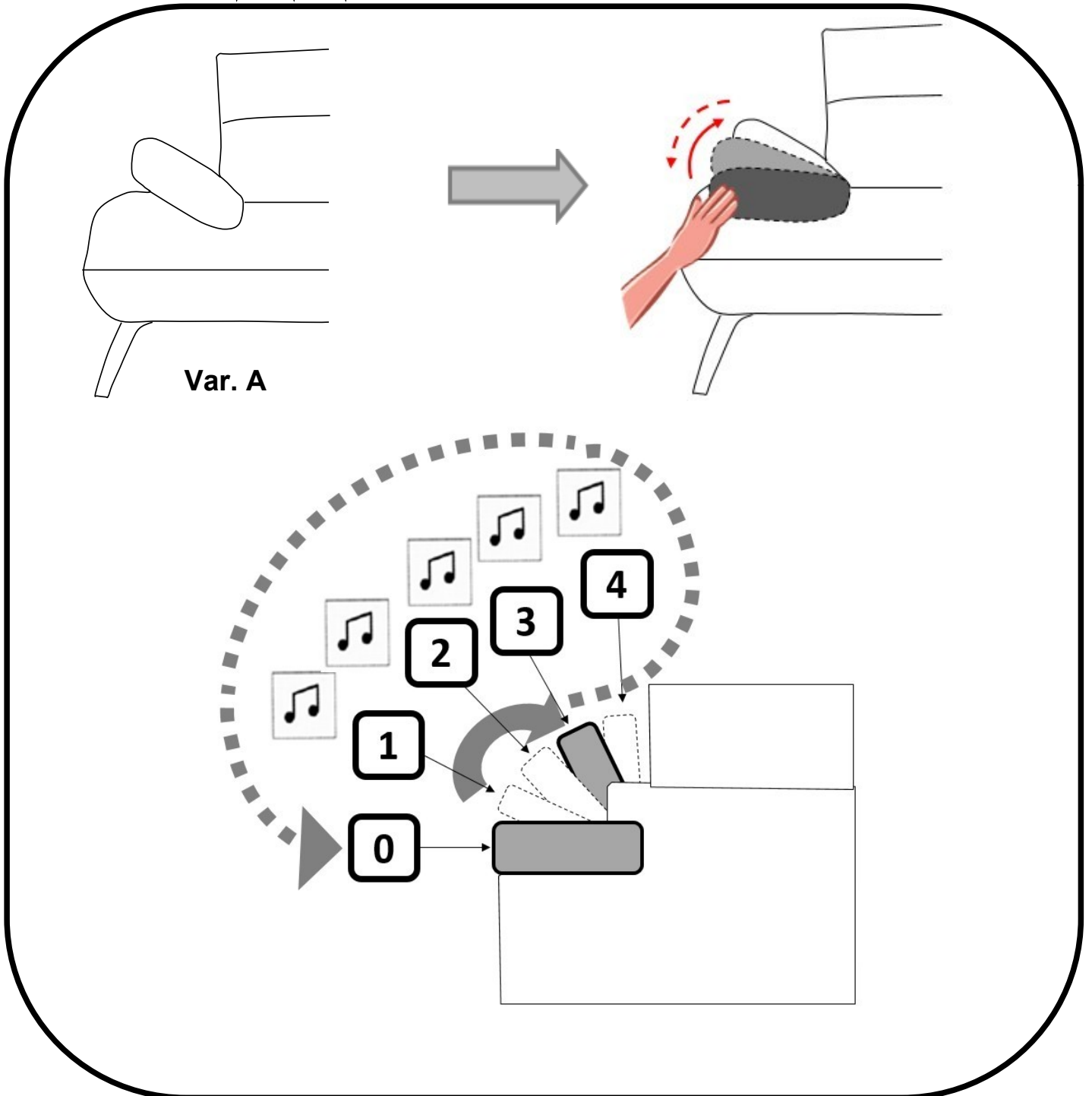
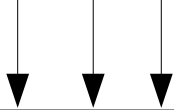
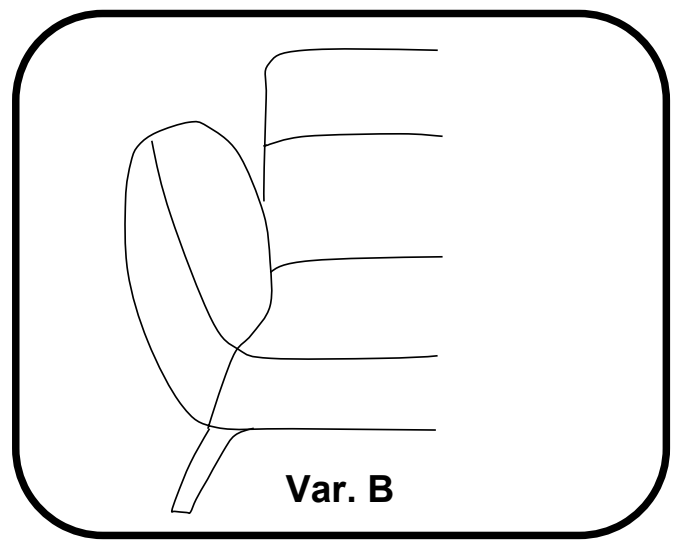
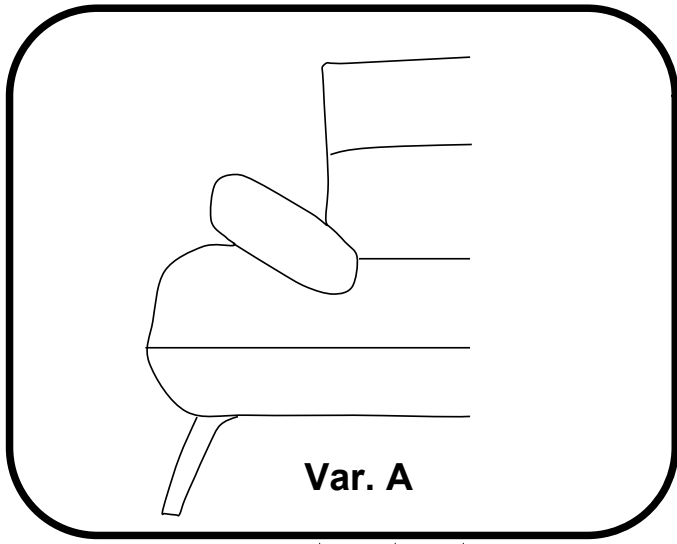

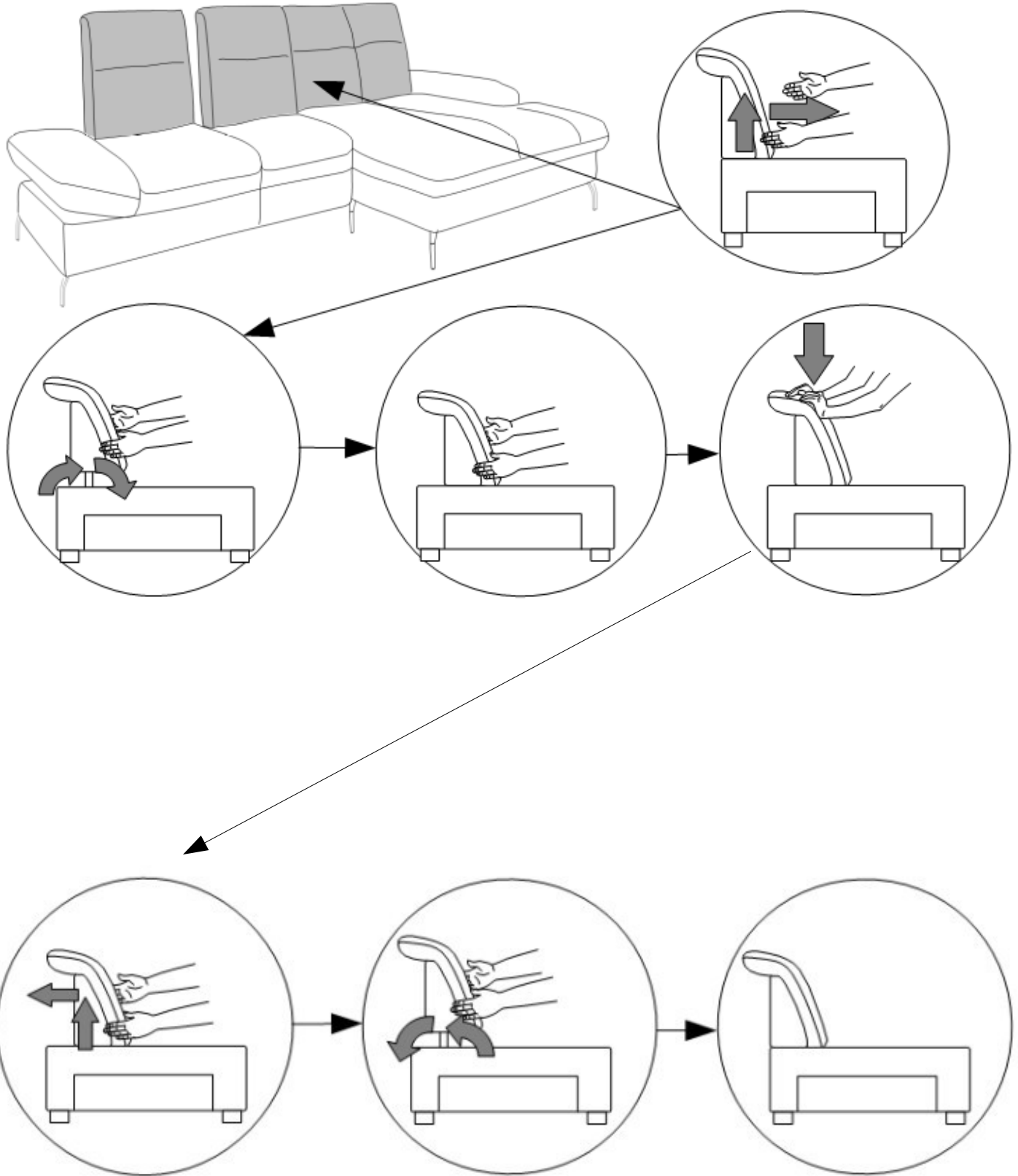
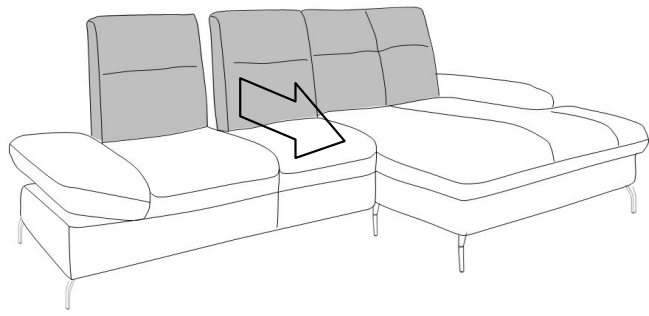

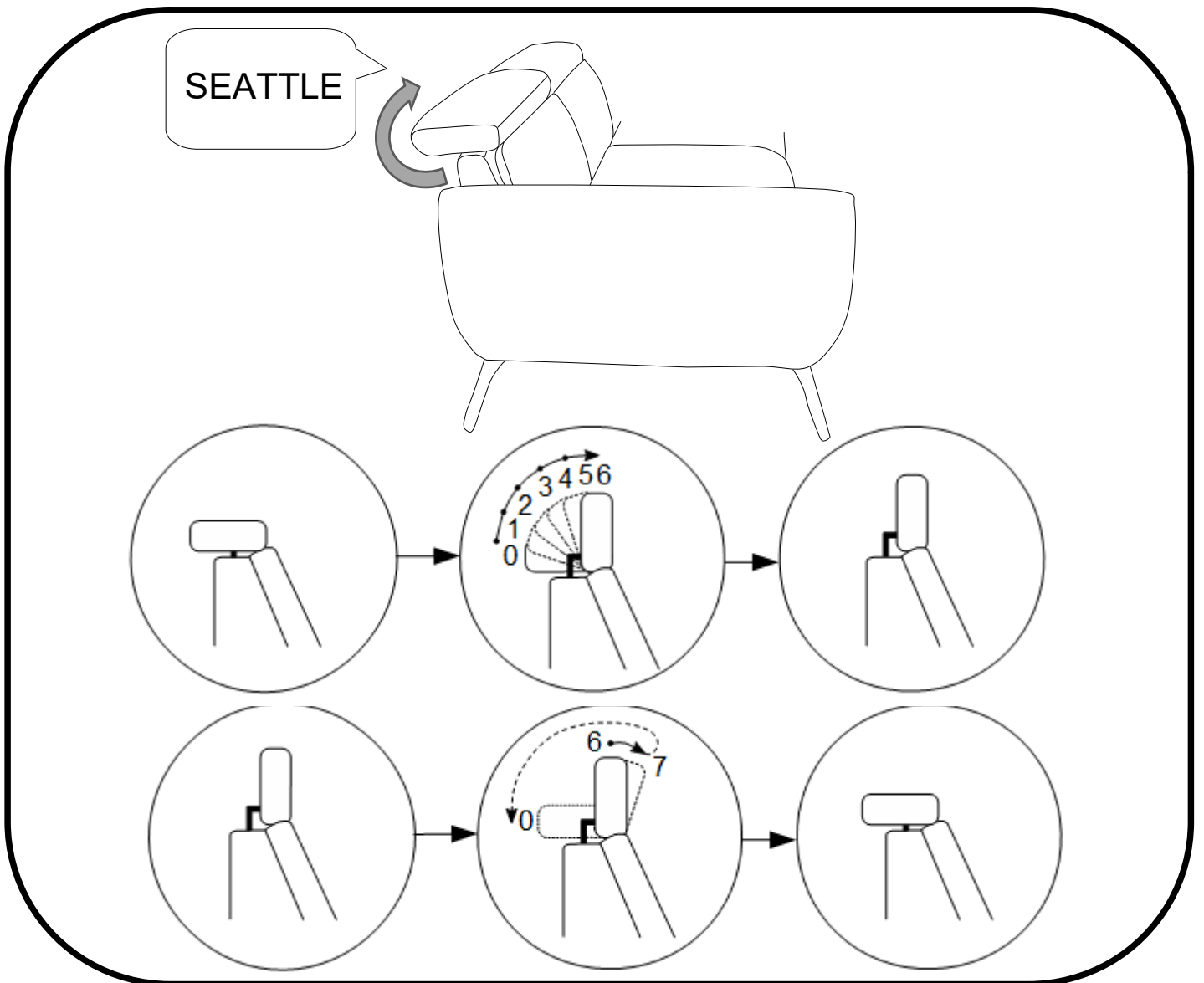
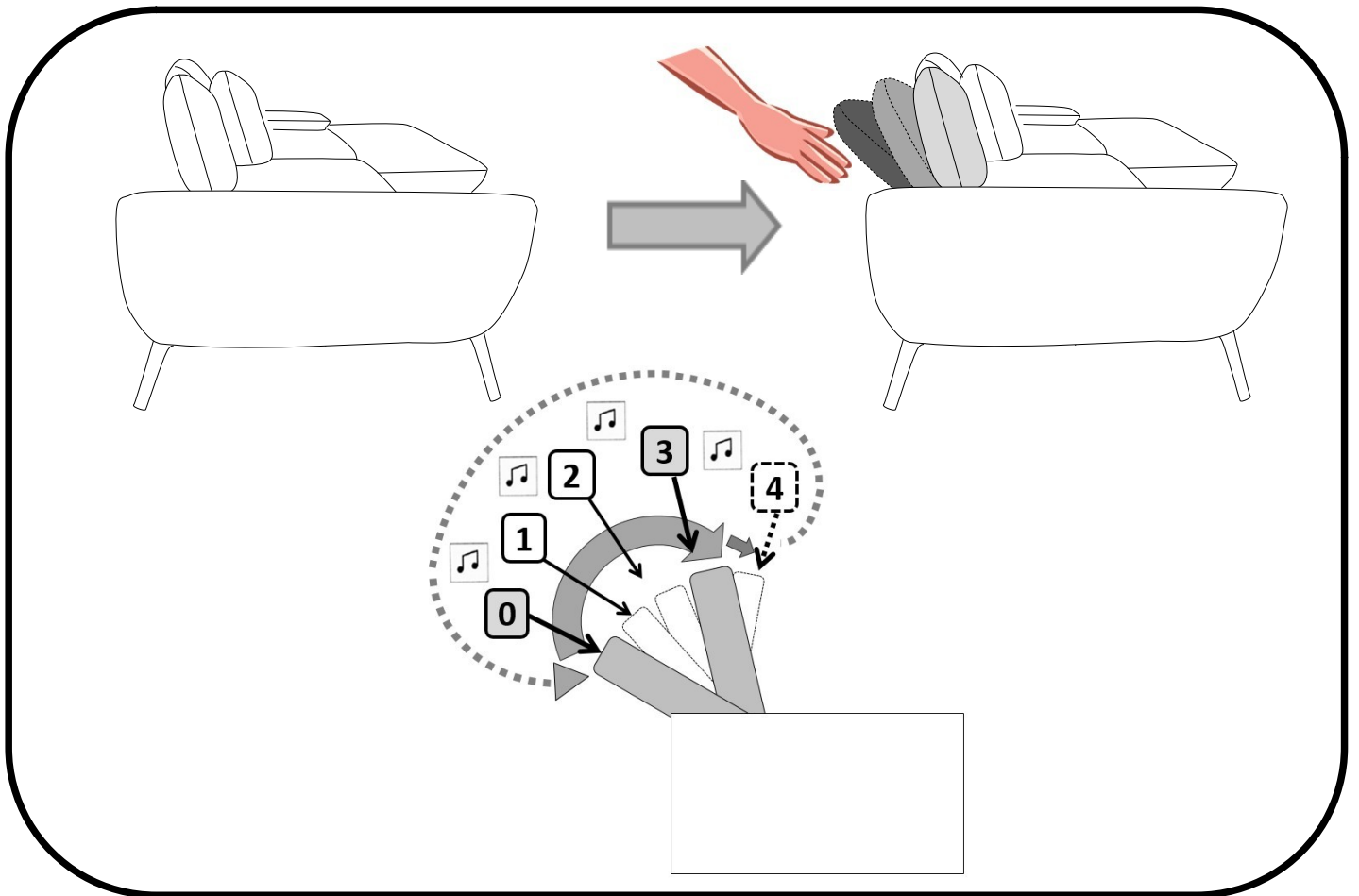

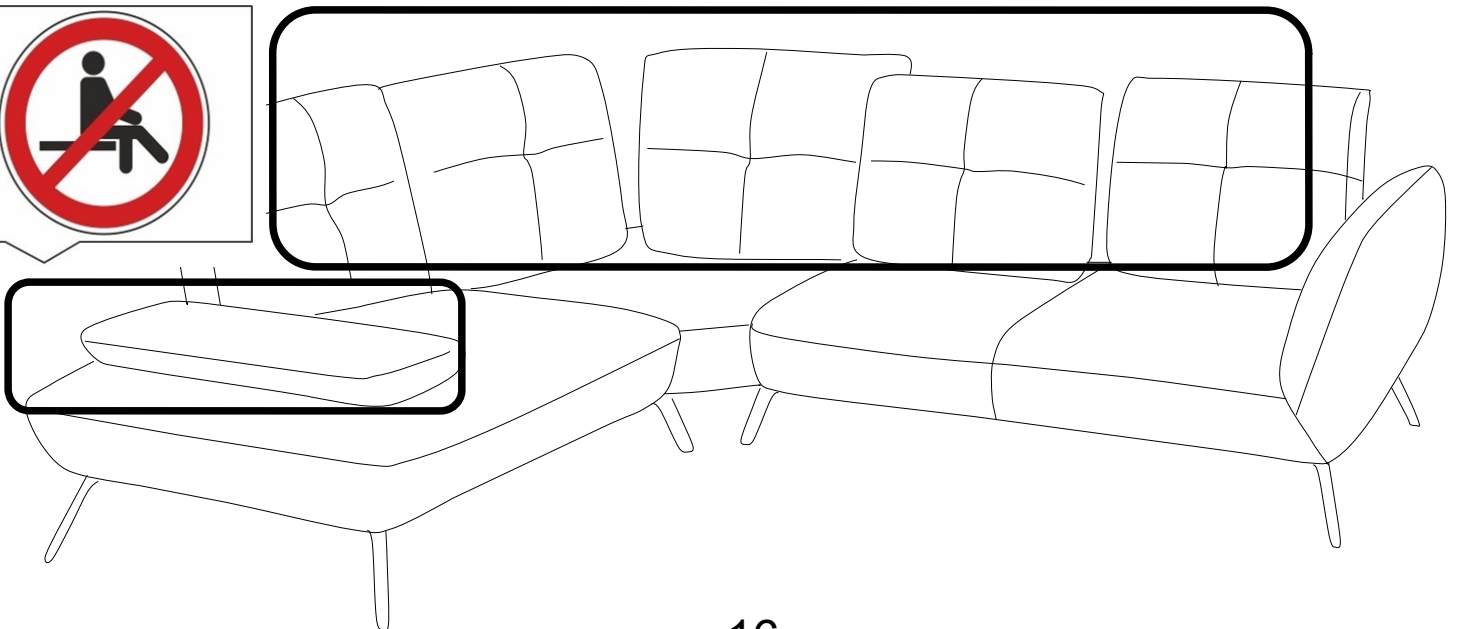
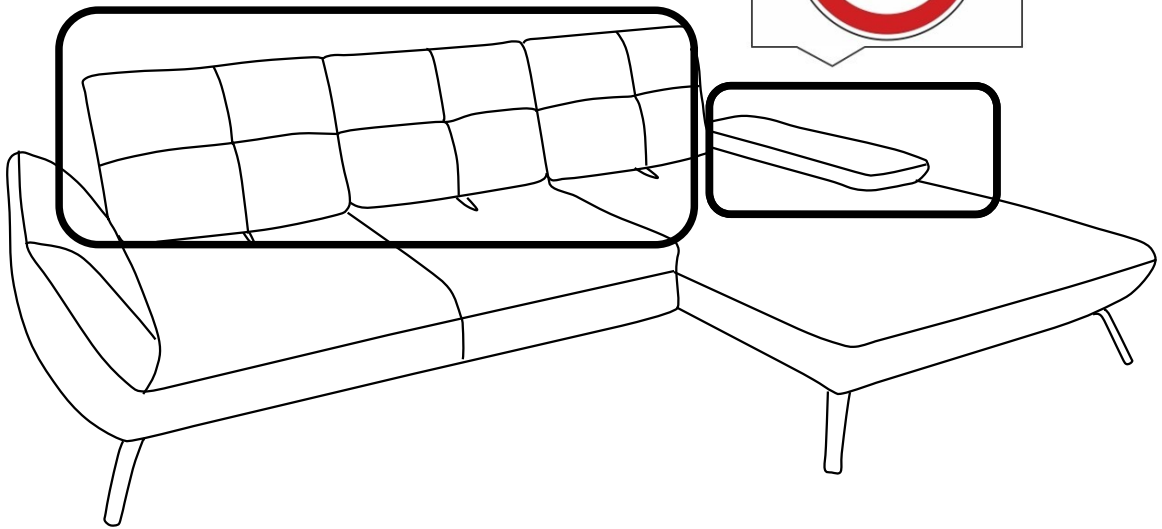
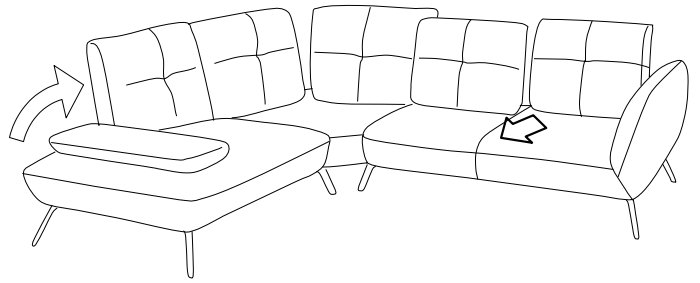
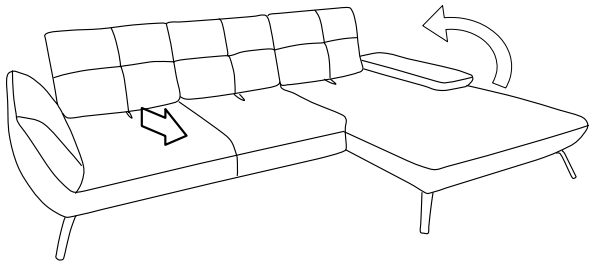

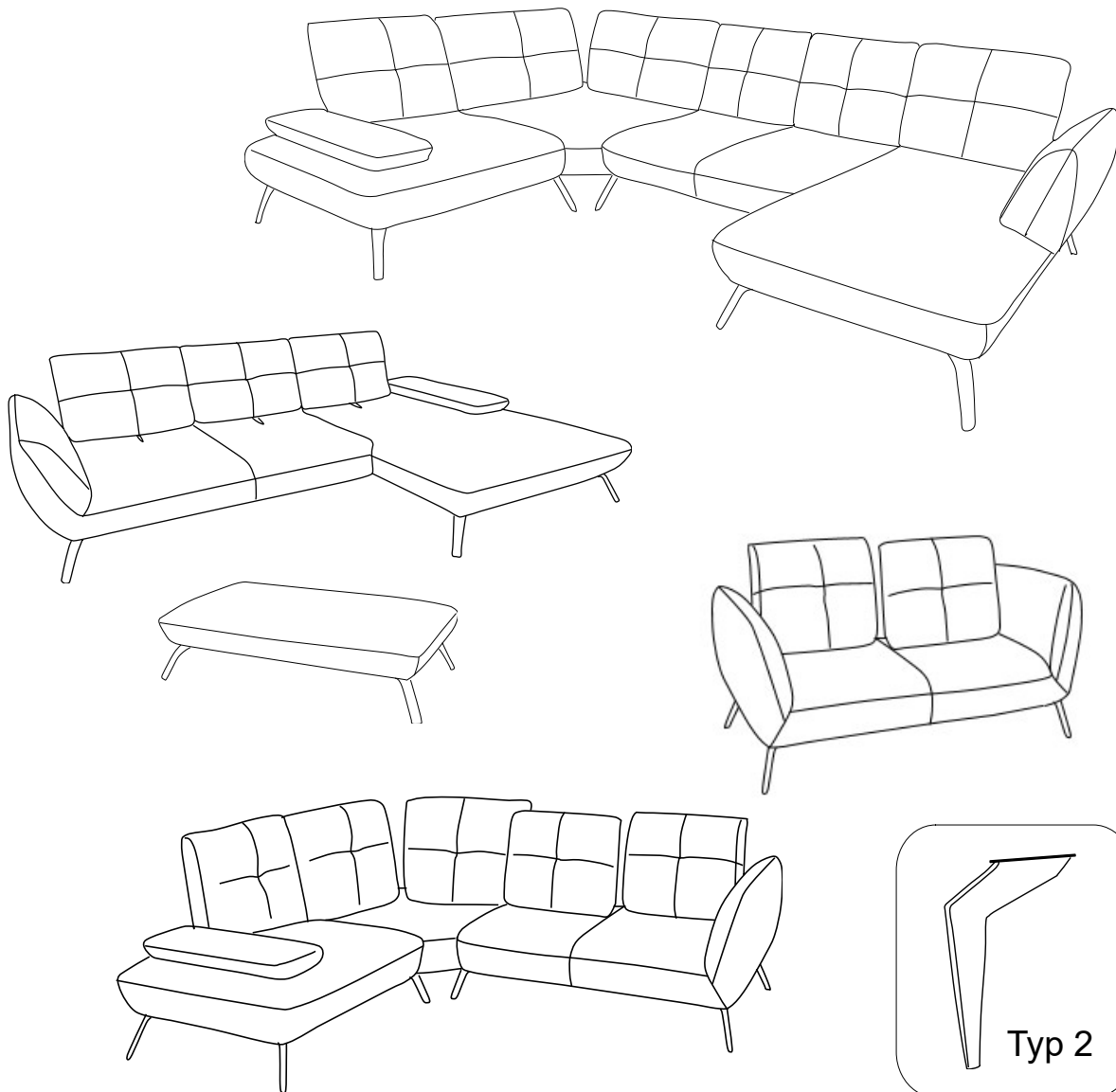

**VITO TICONA
PAYTON**

D MONTAGEANLEITUNG
BEDIENUNGSANLEITUNG

NL HANDLEIDING VOOR DE MONTAGE
GEBRUIKSAANWIJZING

TR MONTAJ TALIMATI
KULLANIM KLAVUZU

RO INSTRUCȚIUNI DE INSTALARE
INSTRUCȚIUNI DE UTILIZARE

FR NOTICE DE MONTAGE
MANUEL INSTRUCTIONS

HU KÖZGYŰLÉS UTASÍTÁSOK
KEZELÉSI UTASÍTÁS

SI NAVODILA ZA MONTAŽO
NAVODILA ZA UPORABO

ES INSTRUCCIONES DE MONTAJE
MANUAL DEL USUARIO

GB ASSEMBLY INSTRUCTIONS
INSTRUCTION MANUAL

PL INSTRUKCJA MONTAŻU
INSTRUKCJA OBSŁUGI

RU ИНСТРУКЦИЯ ПО МОНТАЖУ
ИНСТРУКЦИЯ ПО ЭКСПЛУАТАЦИИ

IT ISTRUZIONI DI MONTAGGIO
MANUALE DI ISTRUZIONI

SK MONTÁŽNY NÁVOD
NÁVOD NA POUŽITIE

CZ MONTÁŽNÍ NÁVOD
NÁVOD K POUŽITÍ

PT INSTRUÇÕES DE MONTAGEM
MANUAL DO USUÁRIO

HR UPUTE ZA MONTAŽU
UPUTE ZA UPOTREBU

Service · Dienstverlening · Serwis · Servis · Сервисная служба · Serviciu · Services · Servizio · Servisný list · Szolgáltatás · Servisní list

Name · Naam · Nazwa · İsim · Название · Nume · Nome ·
Názov · Názov · Název · Neve

Тур · Туре · Тір · Тип · Тіро · Típus

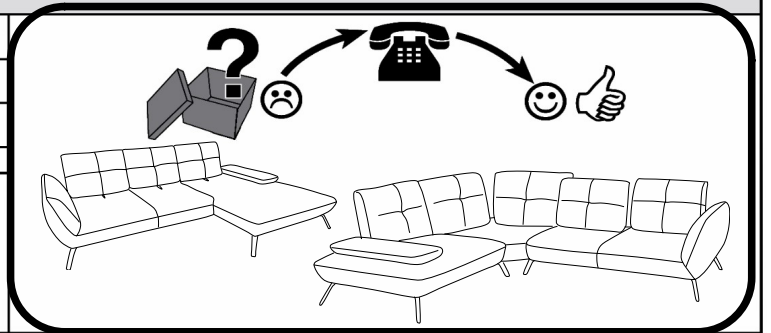
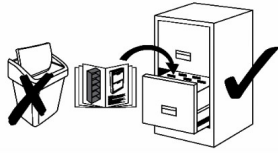

✓	Var. B		 A a1	 B M6x25	 C	 D 4L
 2er			4 x A 4 x a1	4x 3B	1C	
 2er			2 x A 2 x a1	2x 3B	1C	
 2er			4 x A 4 x a1	2x 3B + 2x 4B	1C	
 3er			4 x A 4 x a1	4x 3B	2C	1D
 3er			2 x A 2 x a1	2x 3B	2C	
 3er			4 x A 4 x a1	2x 3B + 2x 4B	2C	

✓ **Var. B**

A

B

M6x25

C

D

4L

E

5L

M8x30

a1

e1

A (x3B) (x4B)

A (x3B) (x4B)

4xA
4xa1

2x**3B**
+
2x**4B**

/

/

A (x3B) (x3B)

A (x3B) (x3B)

2xA
2xa1

2x**3B**

/

/

A (x3B) (x4B)

A (x3B) (x4B)

C C (x3B) (x4B)

C C (x3B) (x4B)

4xA
4xa1

2x**3B**
+
2x**4B**

2C

/

A (x3B) (x3B)

A (x3B) (x3B)

C C (x3B) (x3B)

C C (x3B) (x3B)

A (x3B) (x3B)

A (x3B) (x3B)

4xA
4xa1

4x**3B**

2C

1D

/

A (x3B) (x3B)

A (x3B) (x3B)

C (x3B) (x3B)

E (x3B) (x3B)

A (x3B) (x3B)

A (x3B) (x3B)

4xA
4xa1

4x**3B**

1C

1xE
1xe1

A (x3B) (x3B)

A (x3B) (x3B)

C (x3B) (x3B)

C (x3B) (x3B)

A (x3B) (x3B)

A (x3B) (x3B)

4xA
4xa1

2x**3B**
+
2x**4B**

2C

/

Service · Dienstverlening · Serwis · Servis · Сервисная служба · Serviciu ·
Services · Servizio · Servisný list · Szolgáltatás · Servisní list

Name · Naam · Nazwa · İsim · Название · Nume · Nome ·
Názov · Názov · Název · Neve

Тур · Туре · Tip · Тип · Tiro · Típus

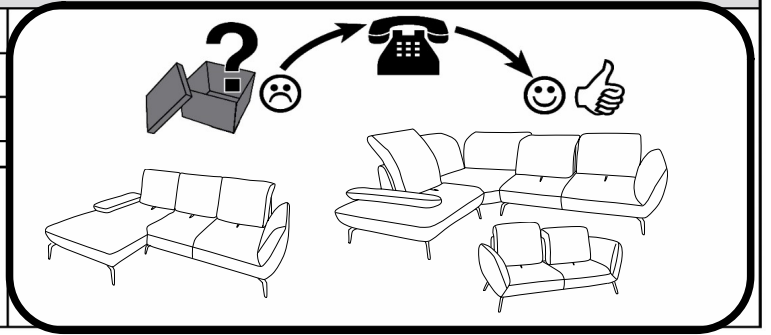
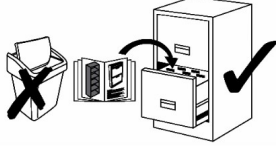









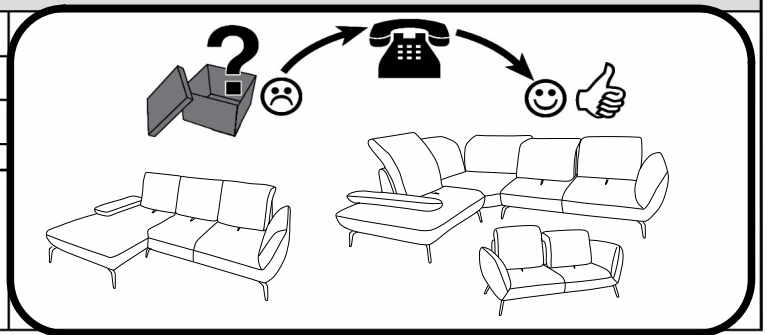
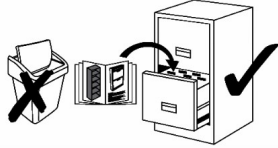

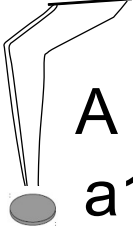
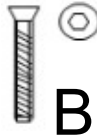
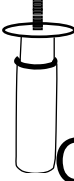

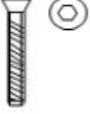

✓	Var. A		A a1	B M6x25	C	D 4L
			4 x A 4 x a1	4x4B	1C	
			2 x A 2 x a1	2x4B	1C	
			4 x A 4 x a1	4x4B	1C	
			4 x A 4 x a1	4x4B	2C	
			2 x A 2 x a1	2x4B	2C	1D
			4 x A 4 x a1	4x4B	2C	
			4 x A 4 x a1	4x4B	/	
			2 x A 2 x a1	2x4B	/	
			4 x A 4 x a1	4x4B	2C	

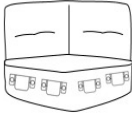
Service · Dienstverlening · Serwis · Servis · Сервисная служба · Serviciu ·
Services · Servizio · Servisný list · Szolgáltatás · Servisní list

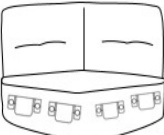
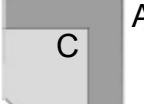
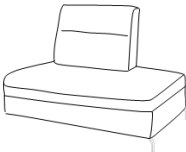
Name · Naam · Nazwa · İsim · Название · Nume · Nome ·
Názov · Názov · Název · Neve

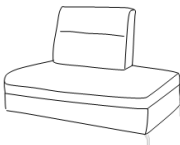
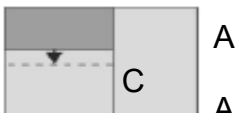
Тур · Туре · Tip · Тип · Típo · Típus

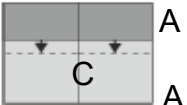

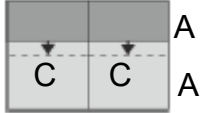
✓			 A a1	 B M6x25	 C	 D 4L	 E 5L	 F M8	 G M8x30
		A  A	4 x A 4 x a1	4x4B	/	1D			
		C  A	1 x A 1 x a1	1x4B	1C	1D	1E	4xF	4xG
		A  A	3 x A 3 x a1	3x4B	1C	1D	1E	8xF	8xG
		A  A	4 x A 4 x a1	4x4B	1C	1D			
		 A	2 x A 2 x a1	2x4B	1C	1D			
	 2er	 A	2 x A 2 x a1	2x4B	1C	1D			
	 3er	 A	2 x A 2 x a1	2x4B	2C	1D			

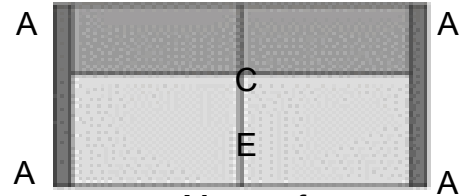
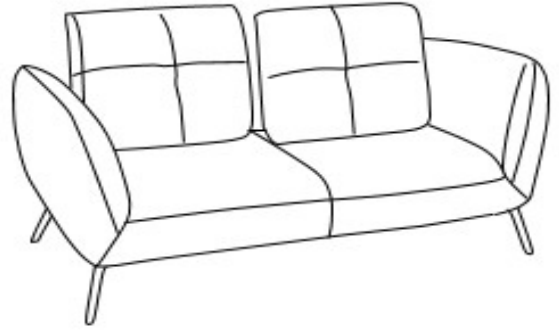
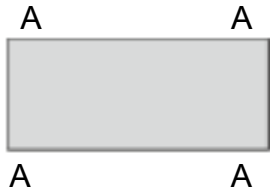
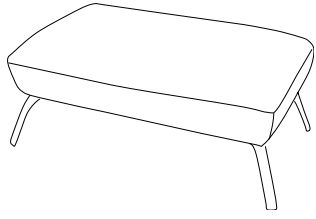

Megasofa

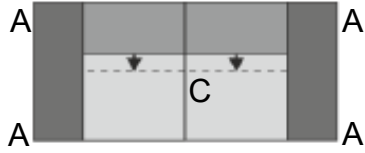
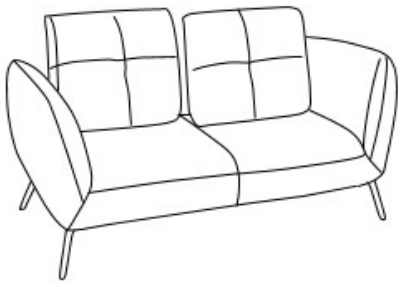

2er

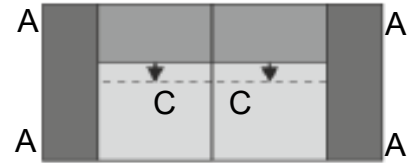
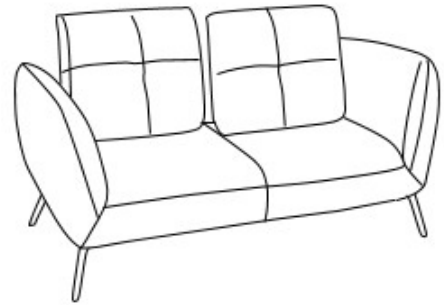

3er

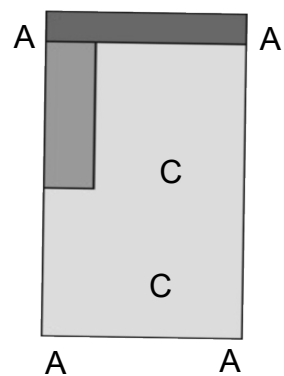
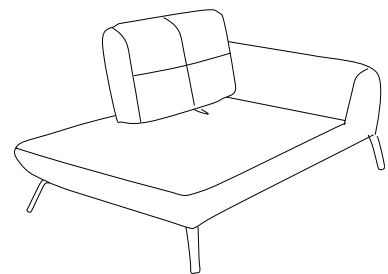
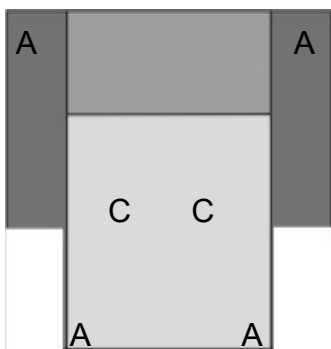
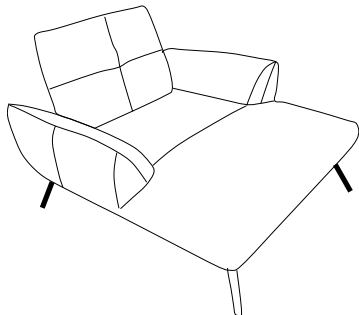

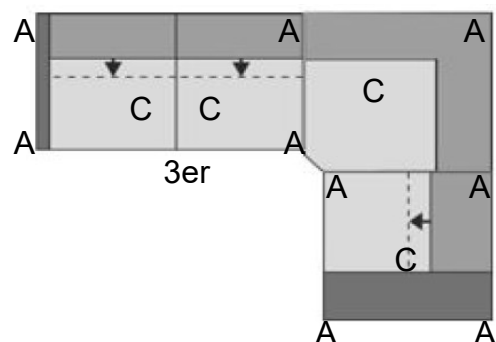
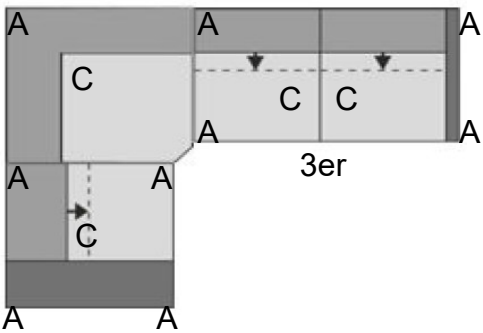
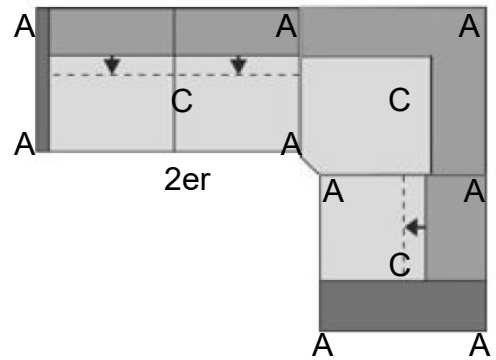
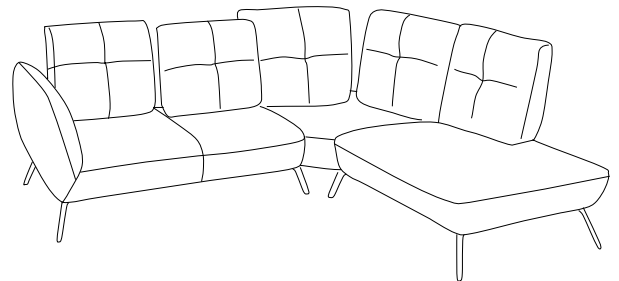
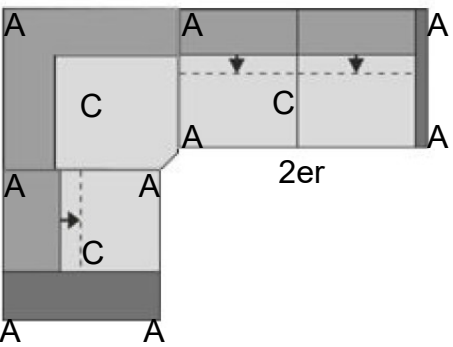
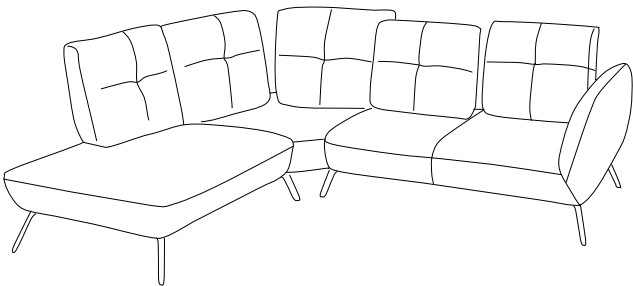
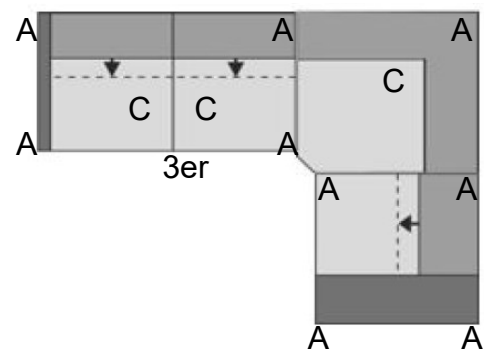
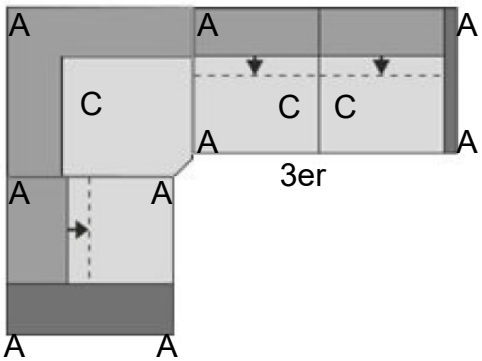
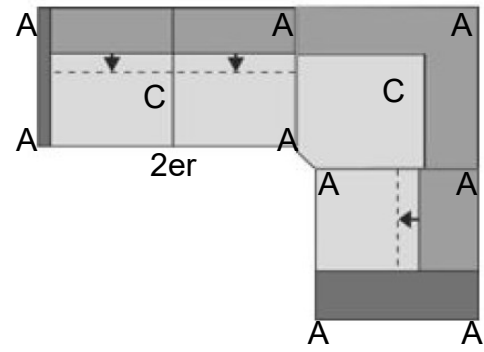
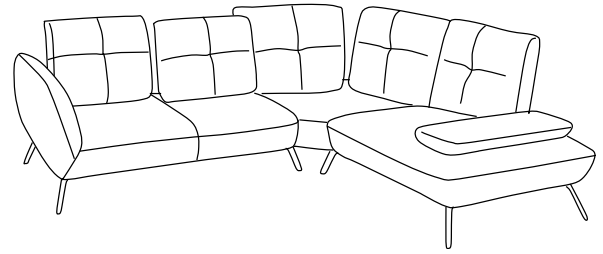
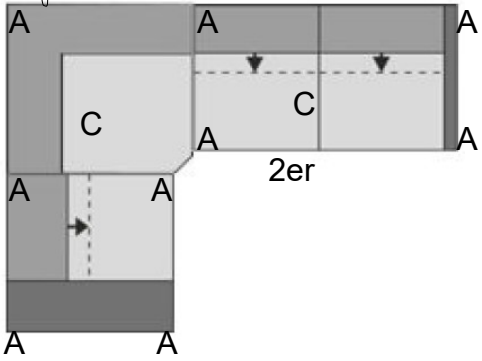
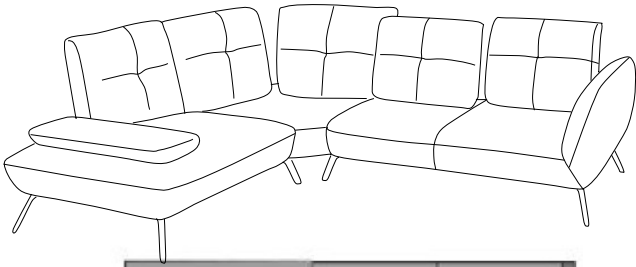

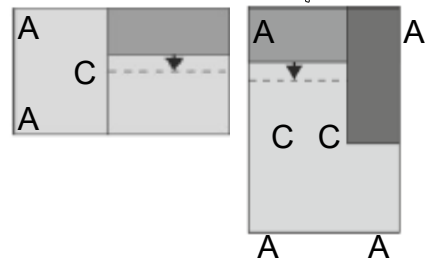
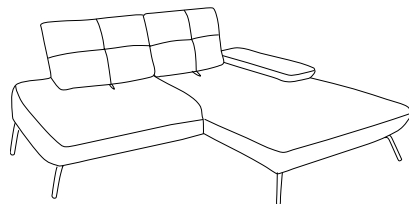
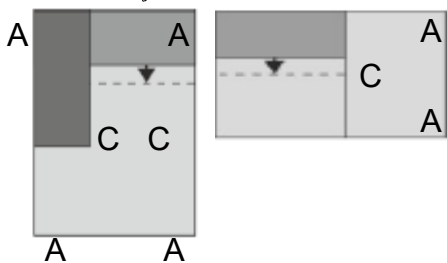
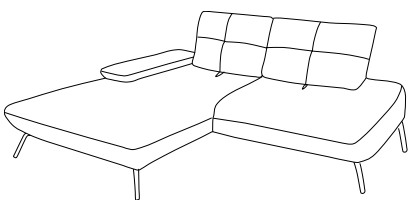
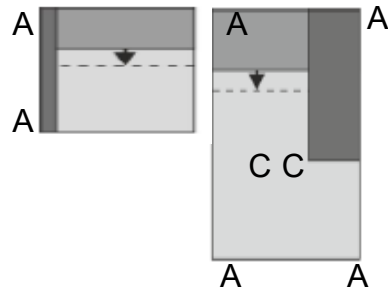
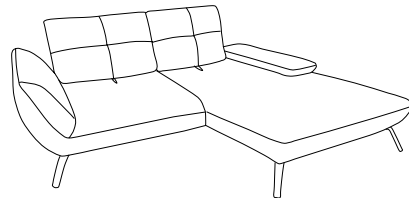
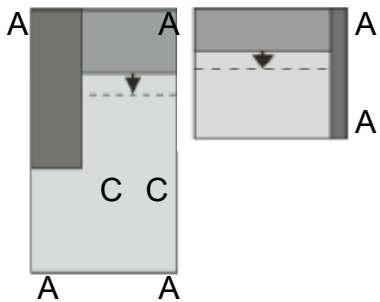
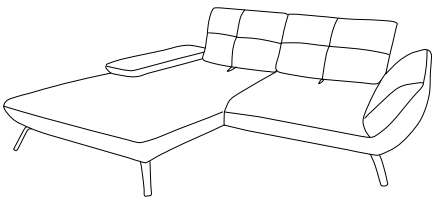
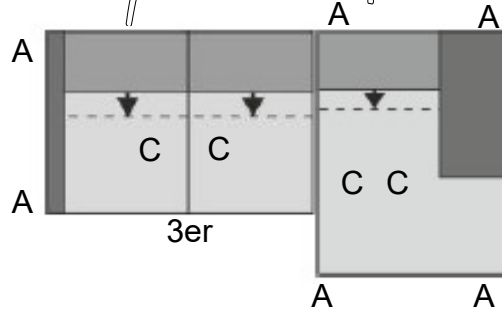
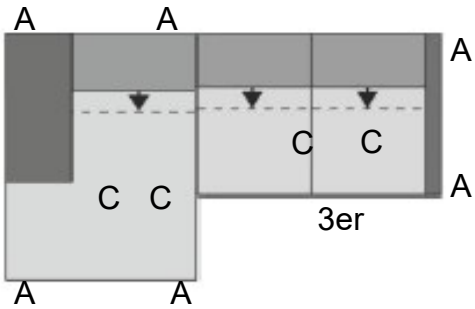
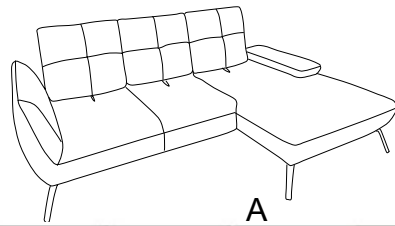
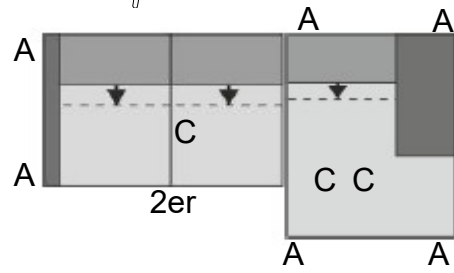
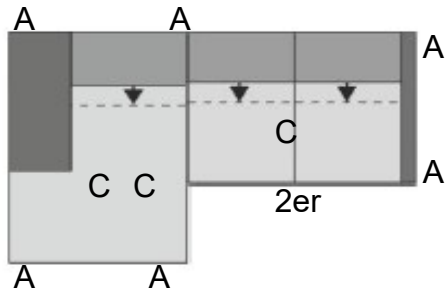
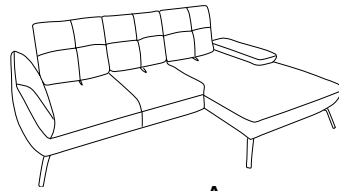

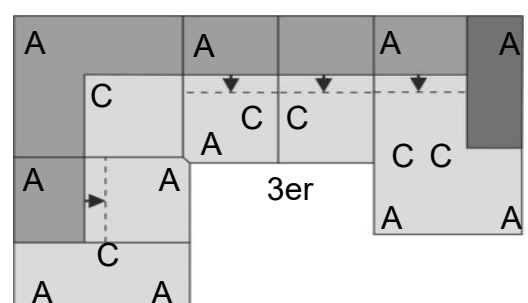
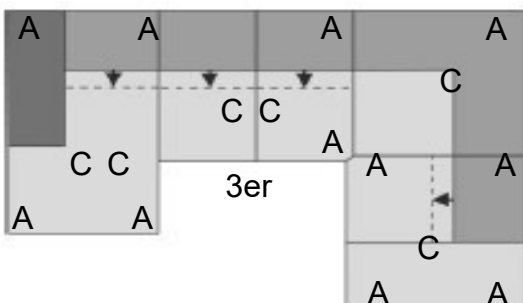
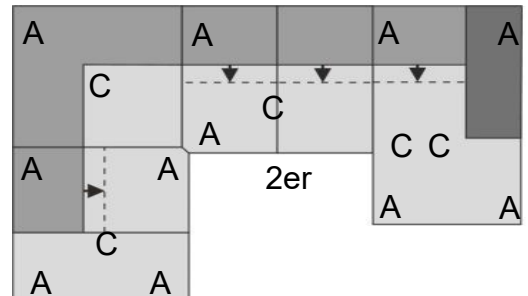
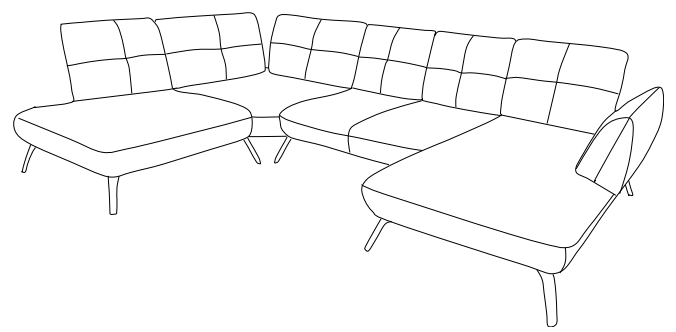
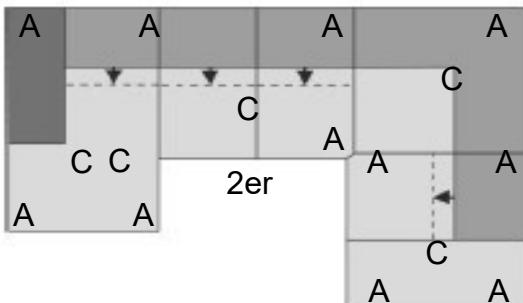
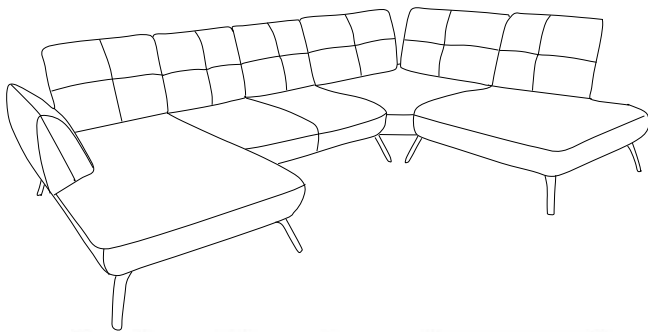
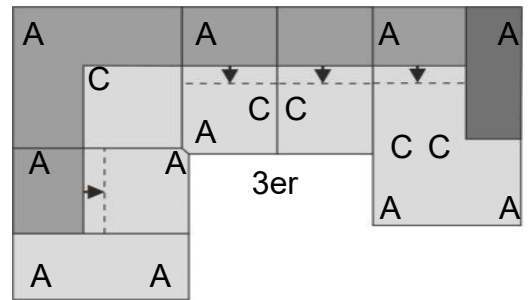
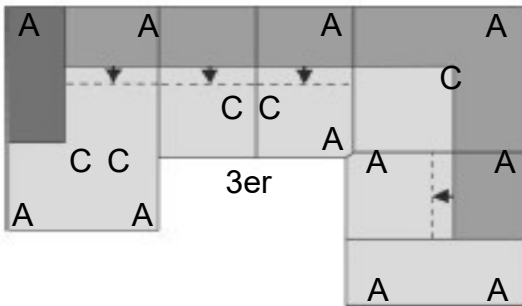
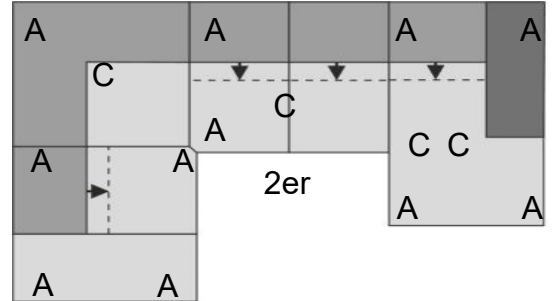
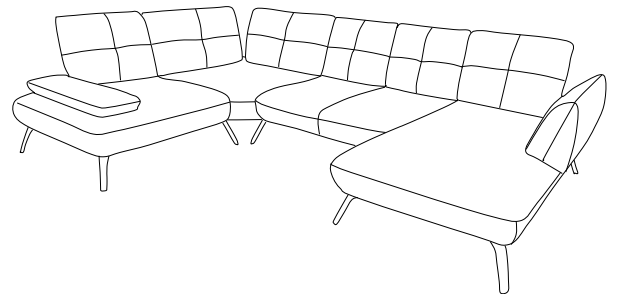
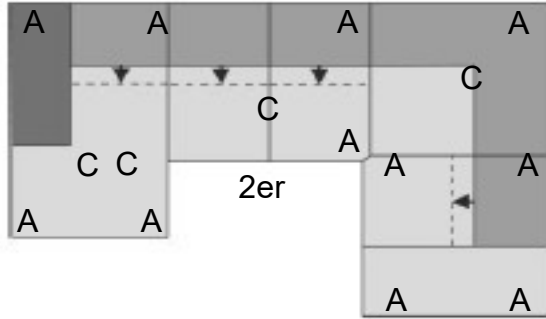
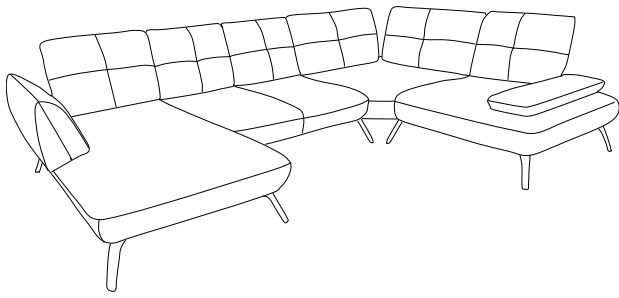

1

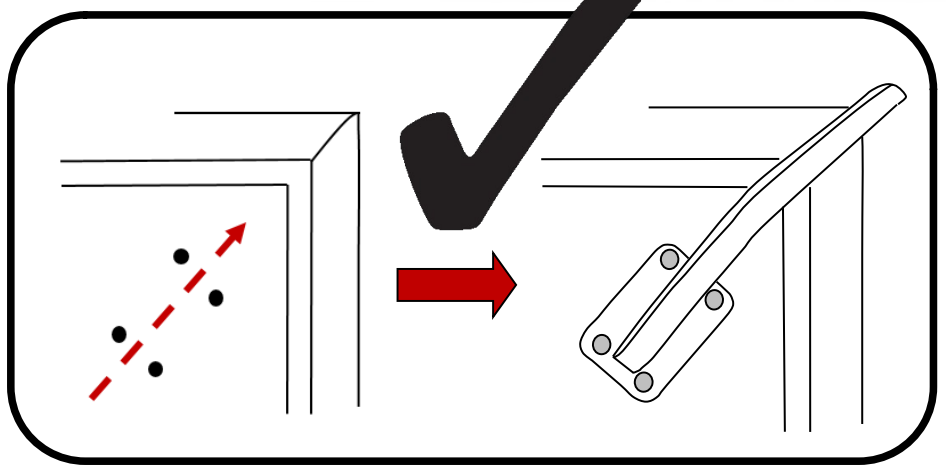
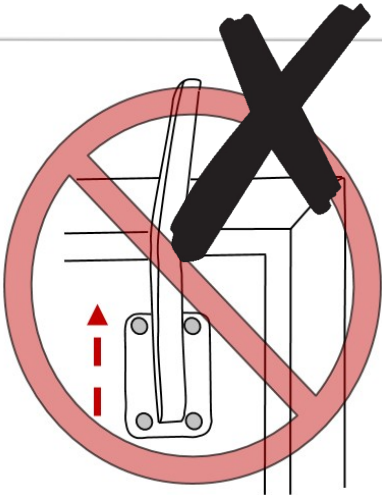
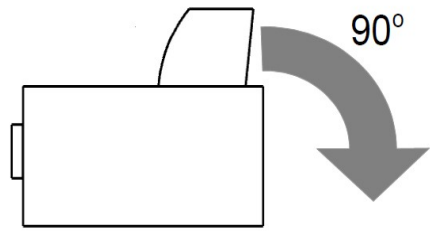

2

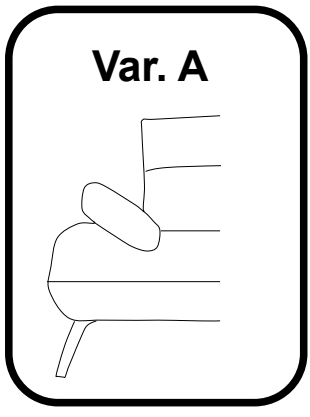

A

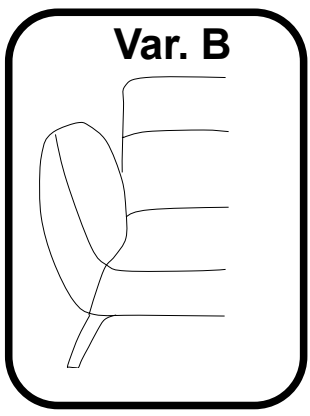
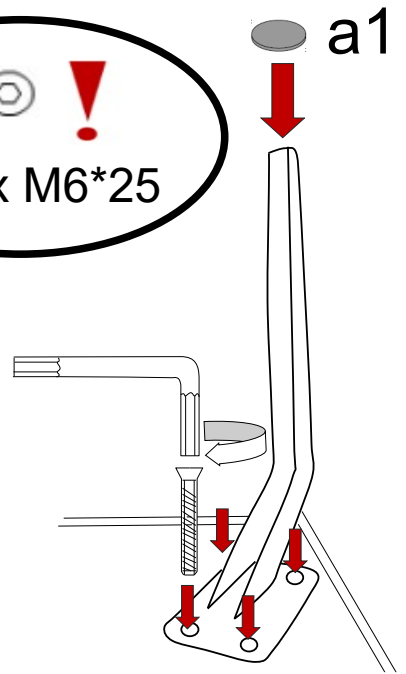
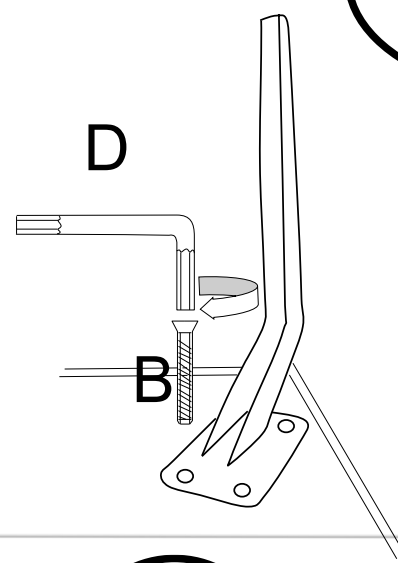
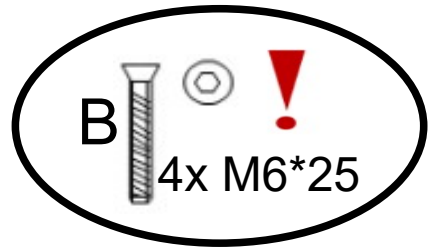

A

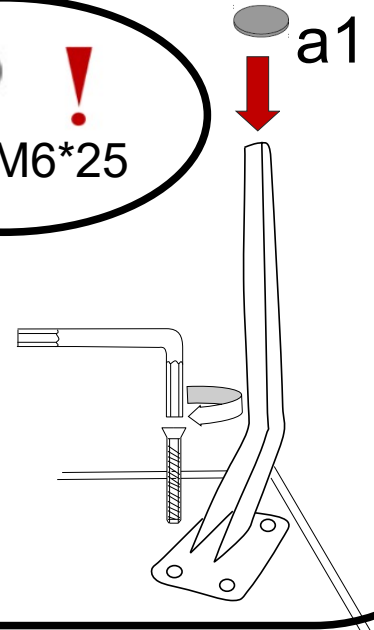
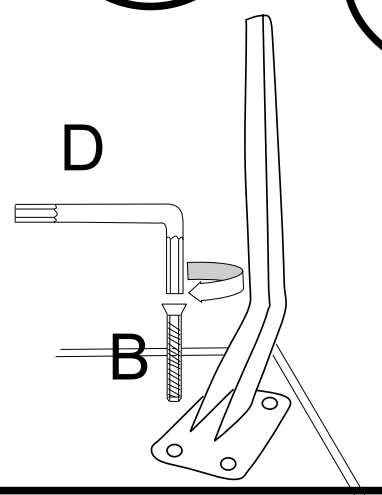
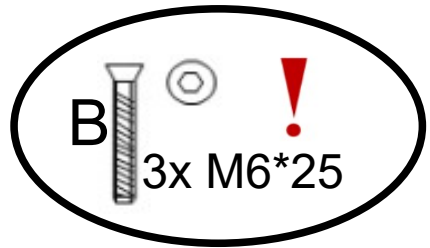

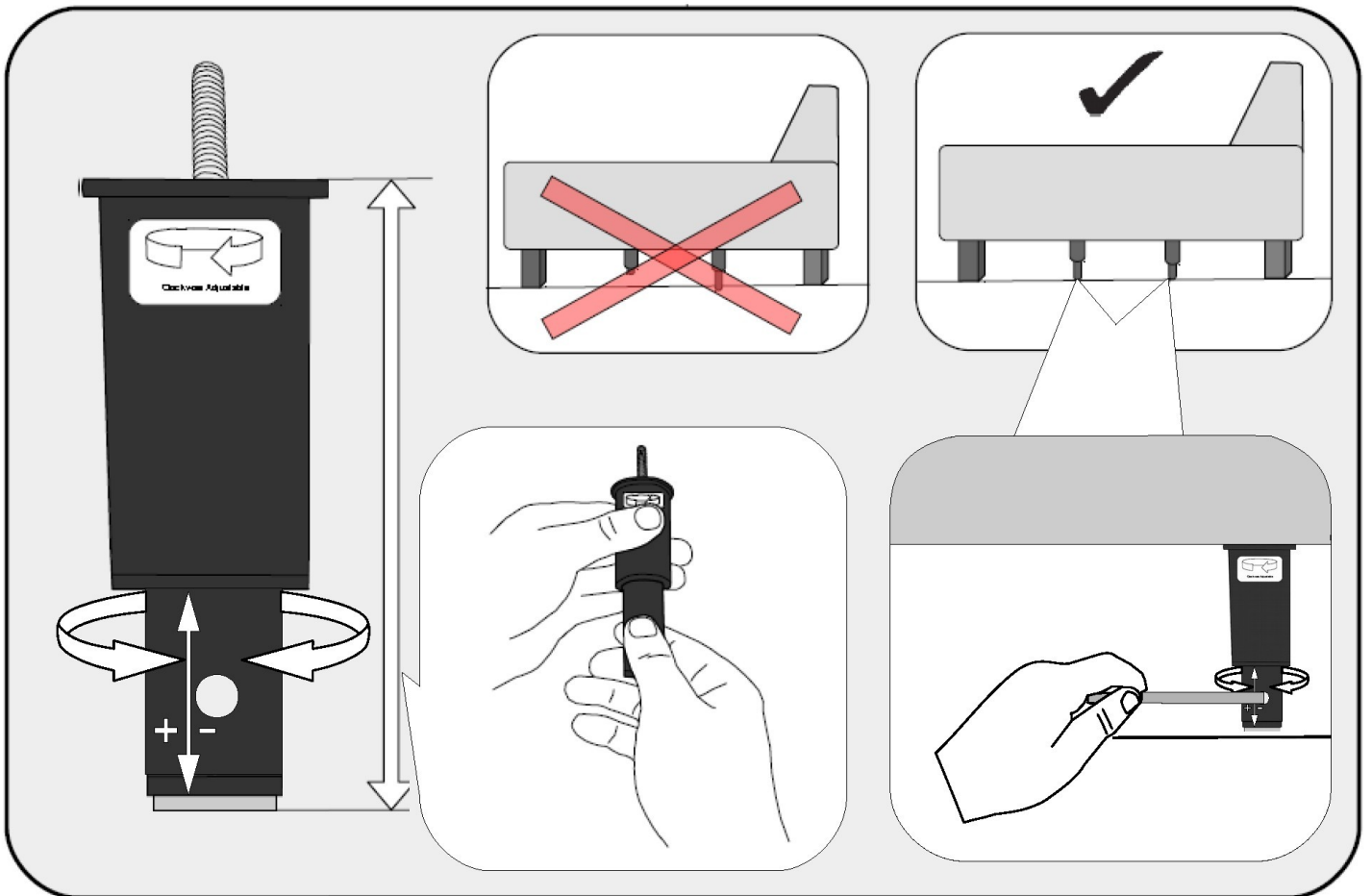
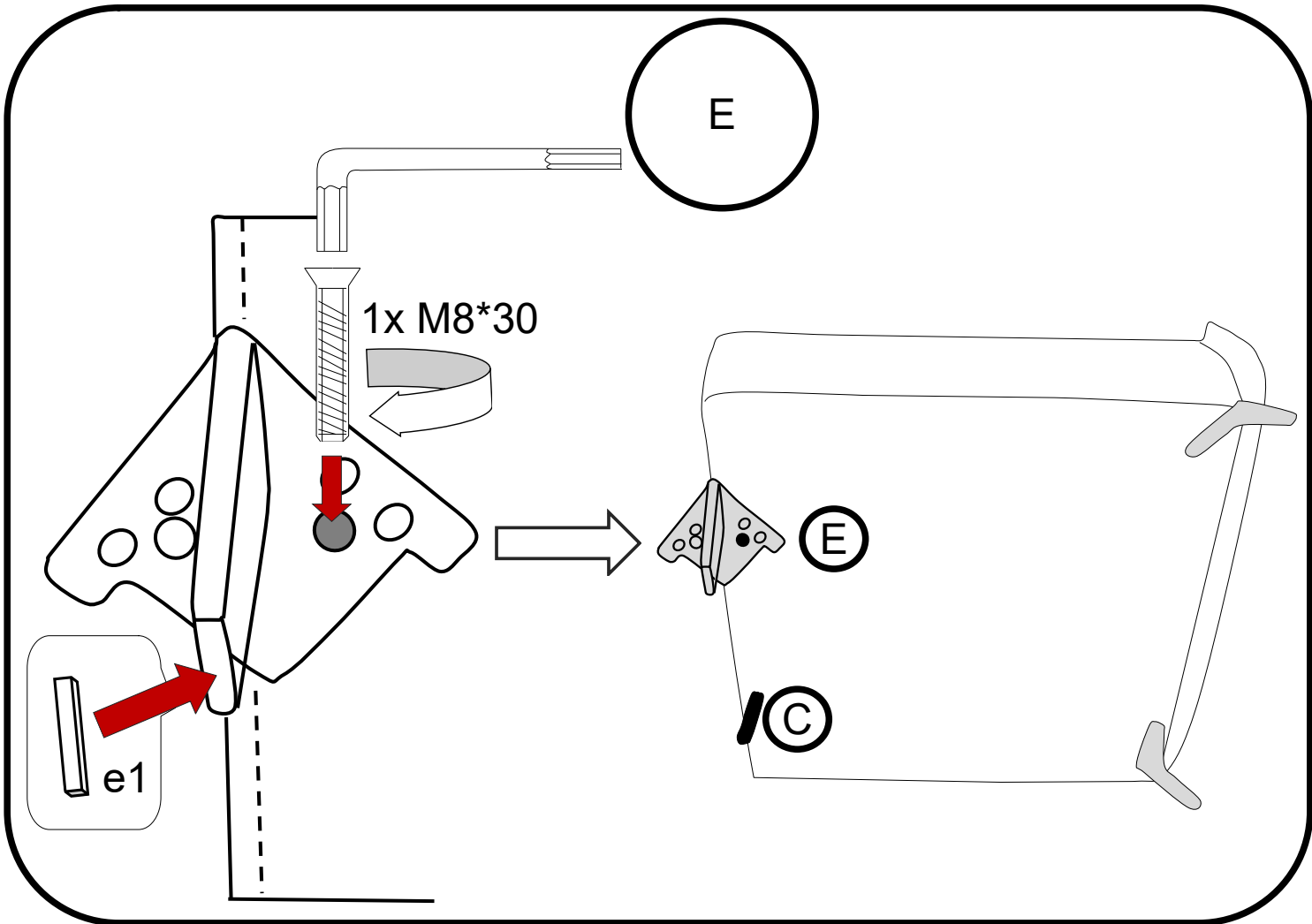

3

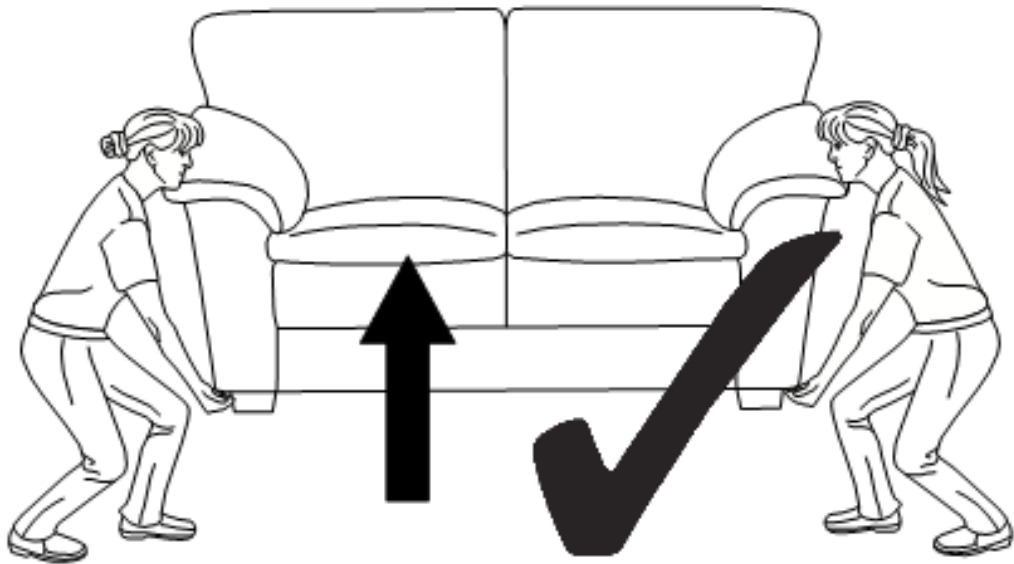
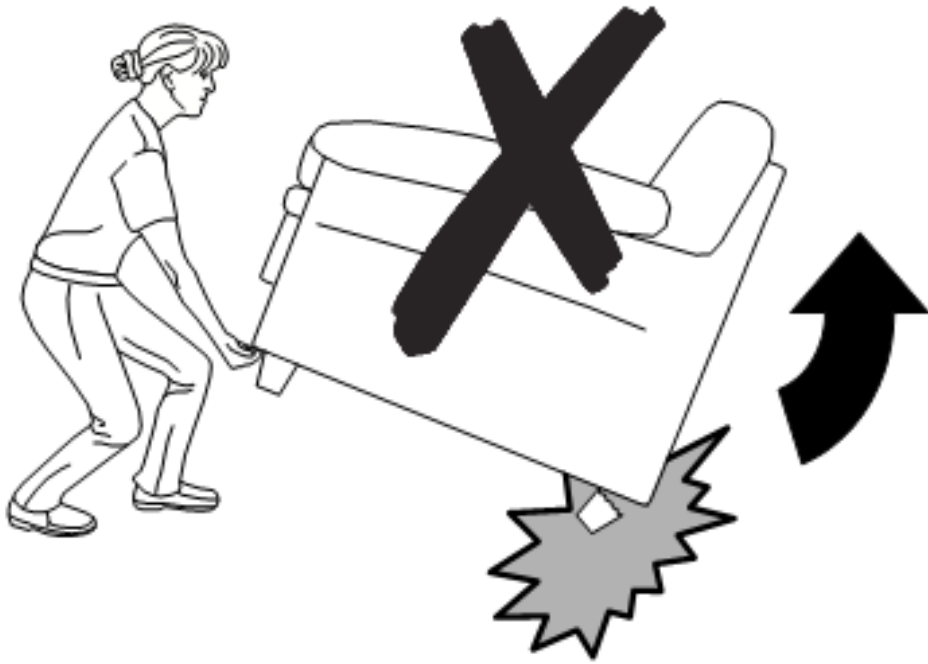
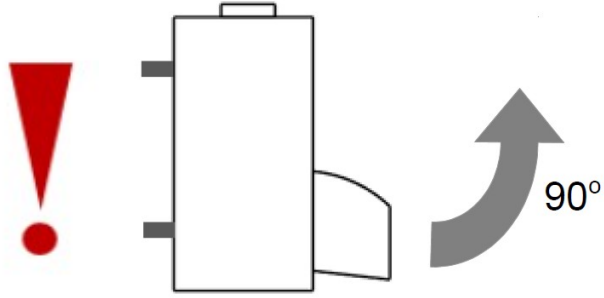

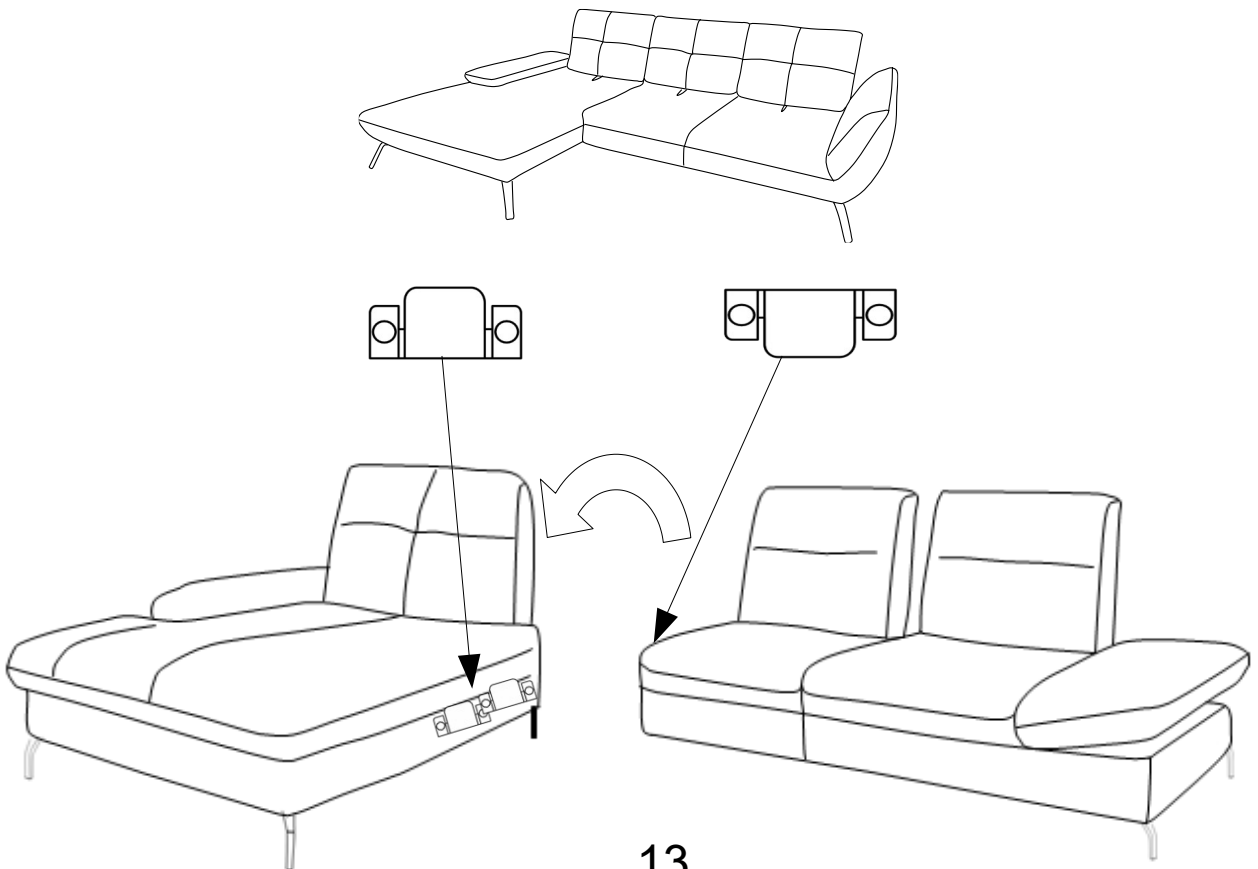
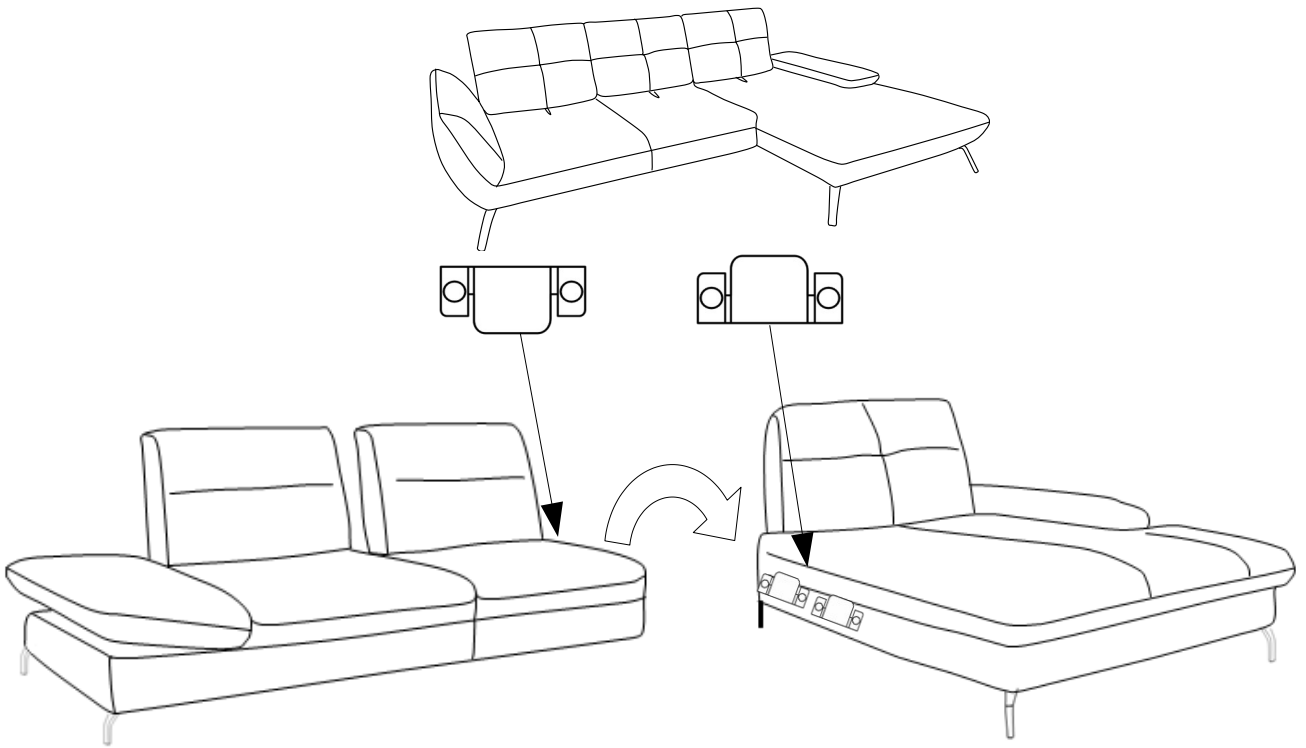

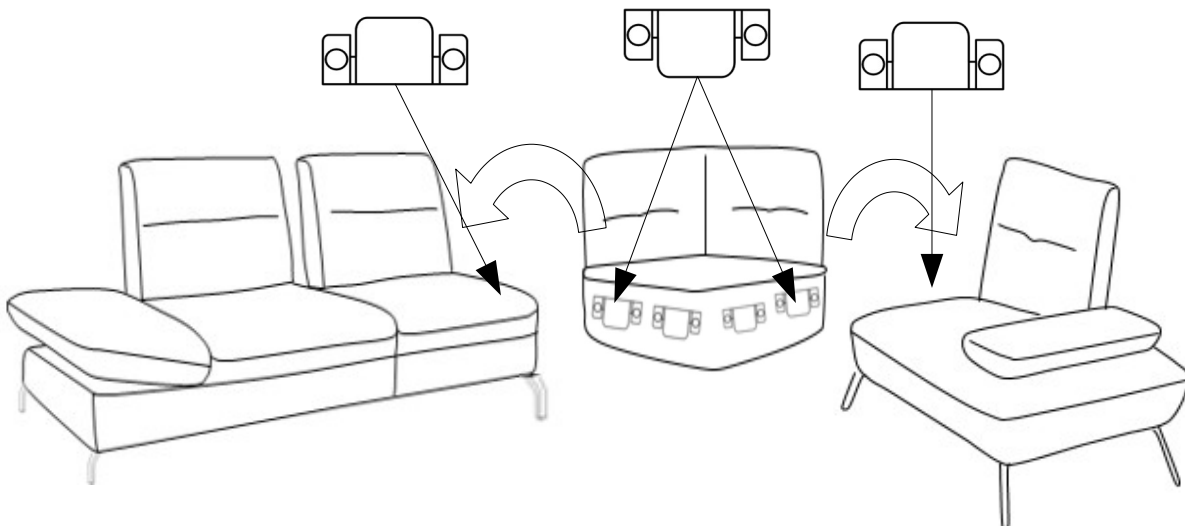
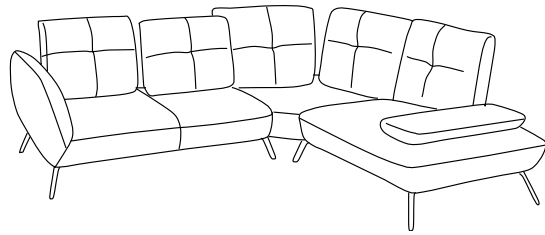
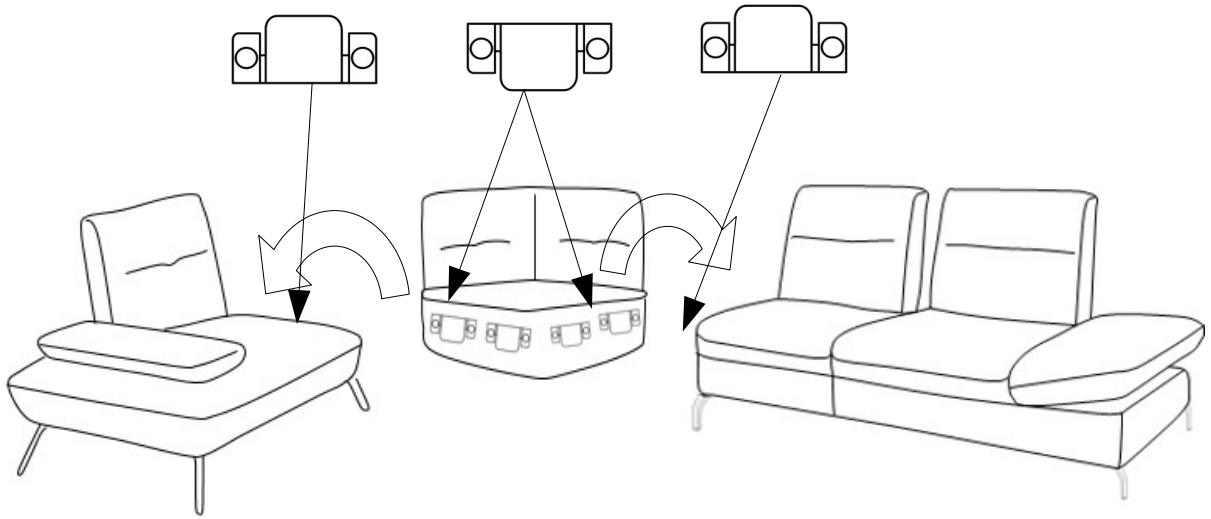
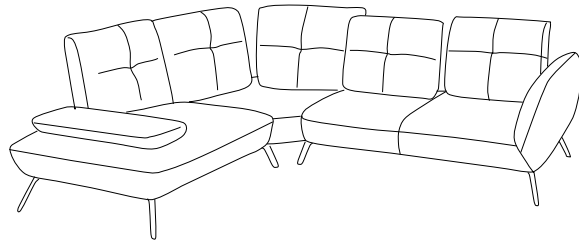

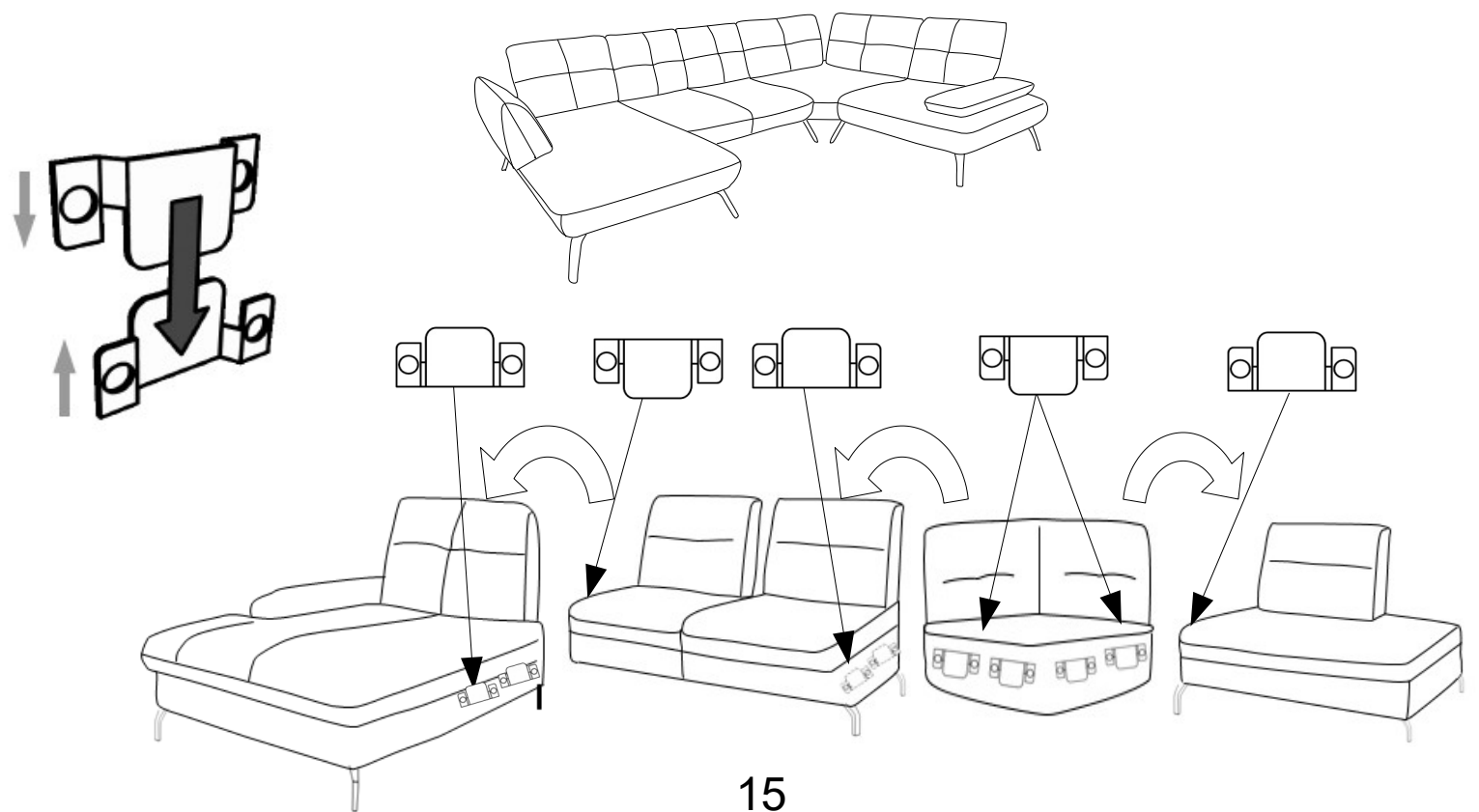
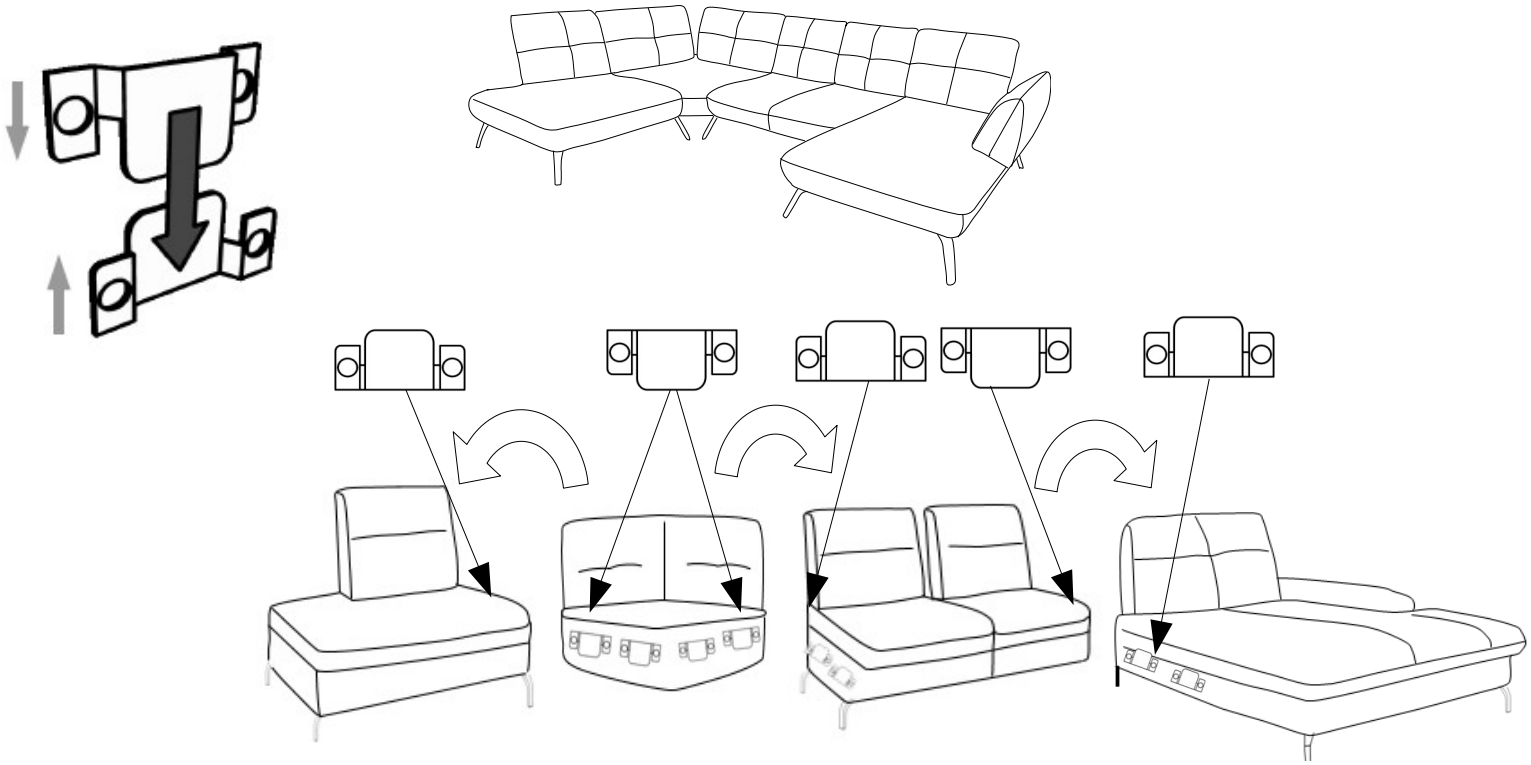

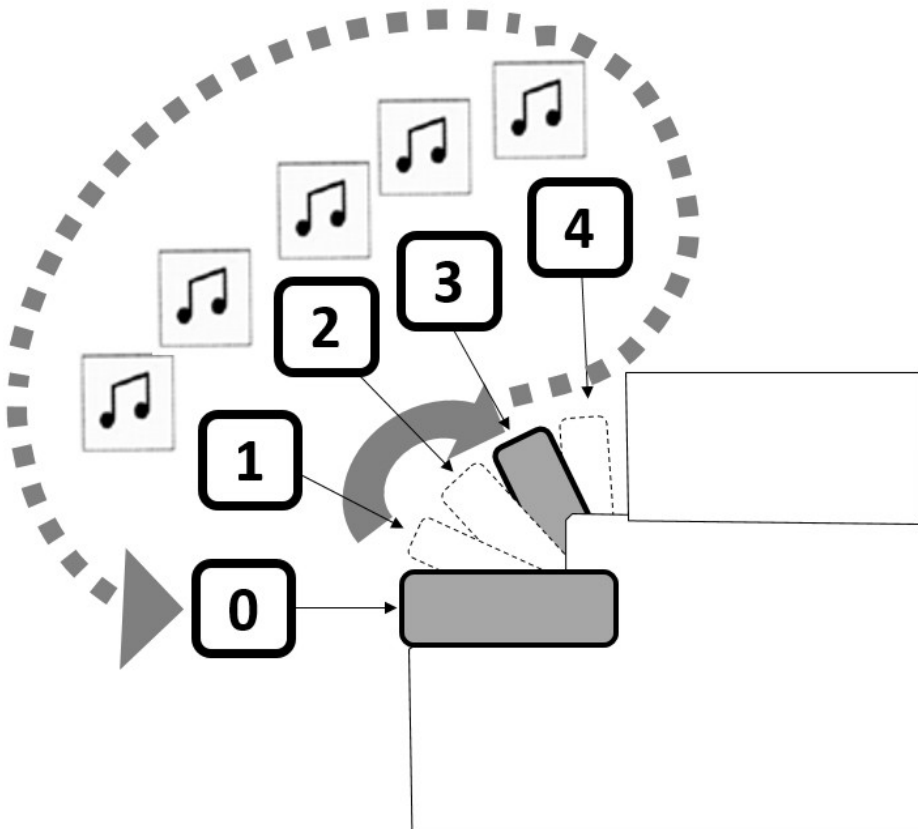
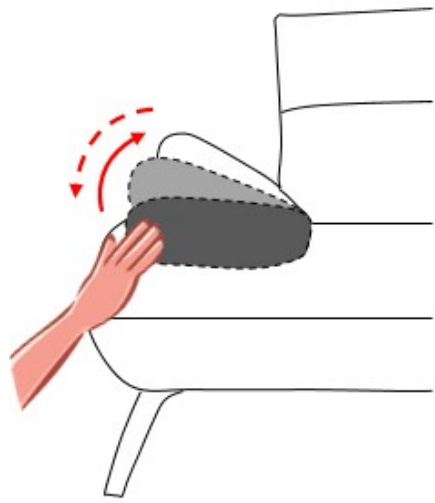
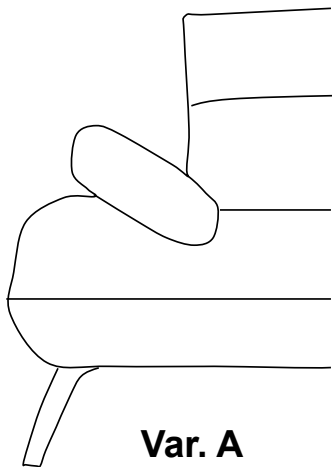
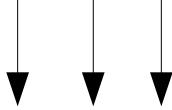
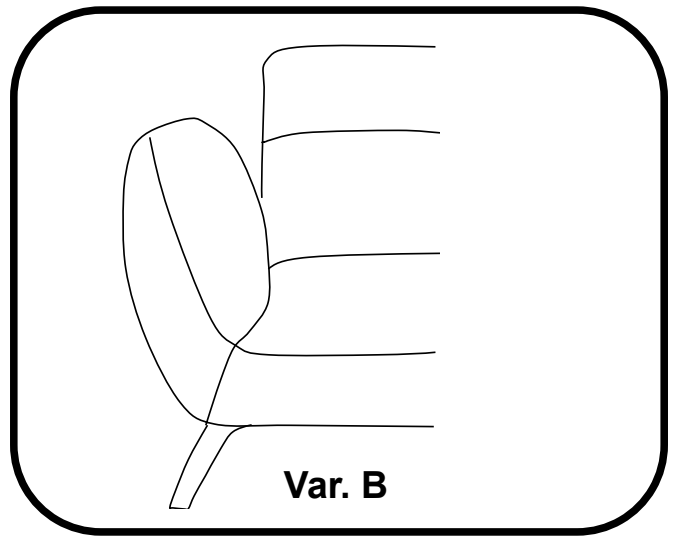
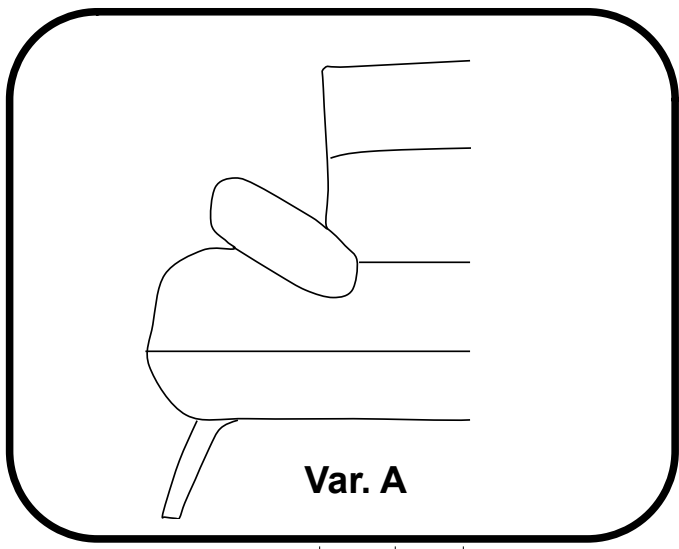

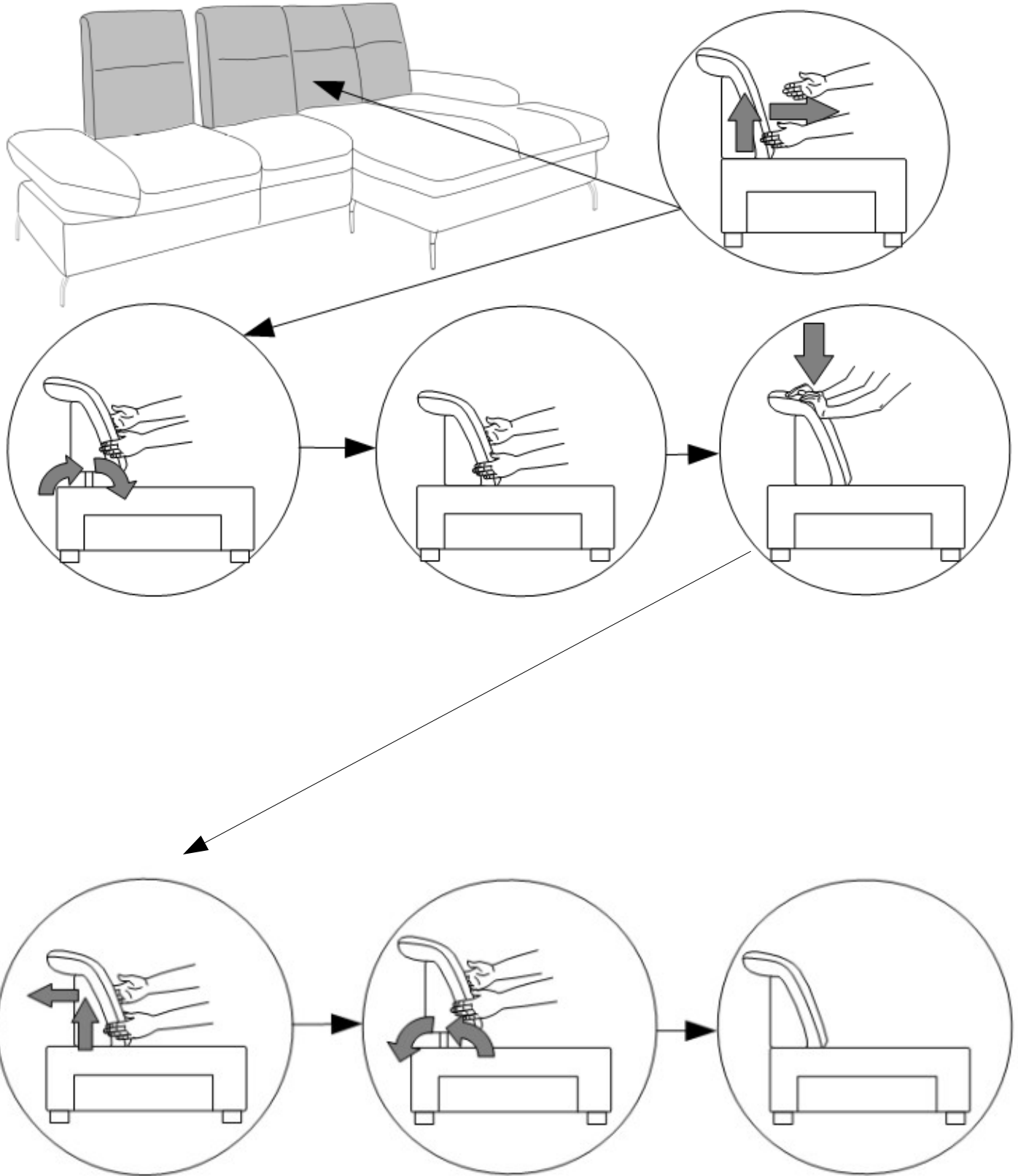
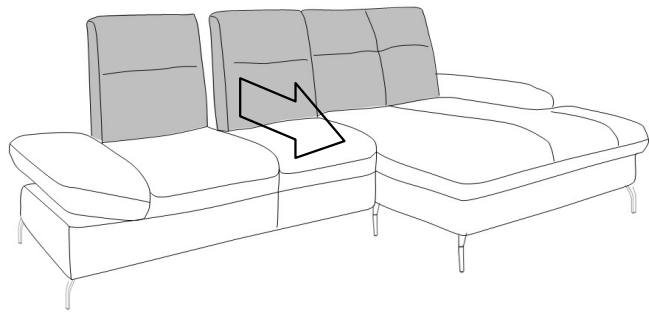

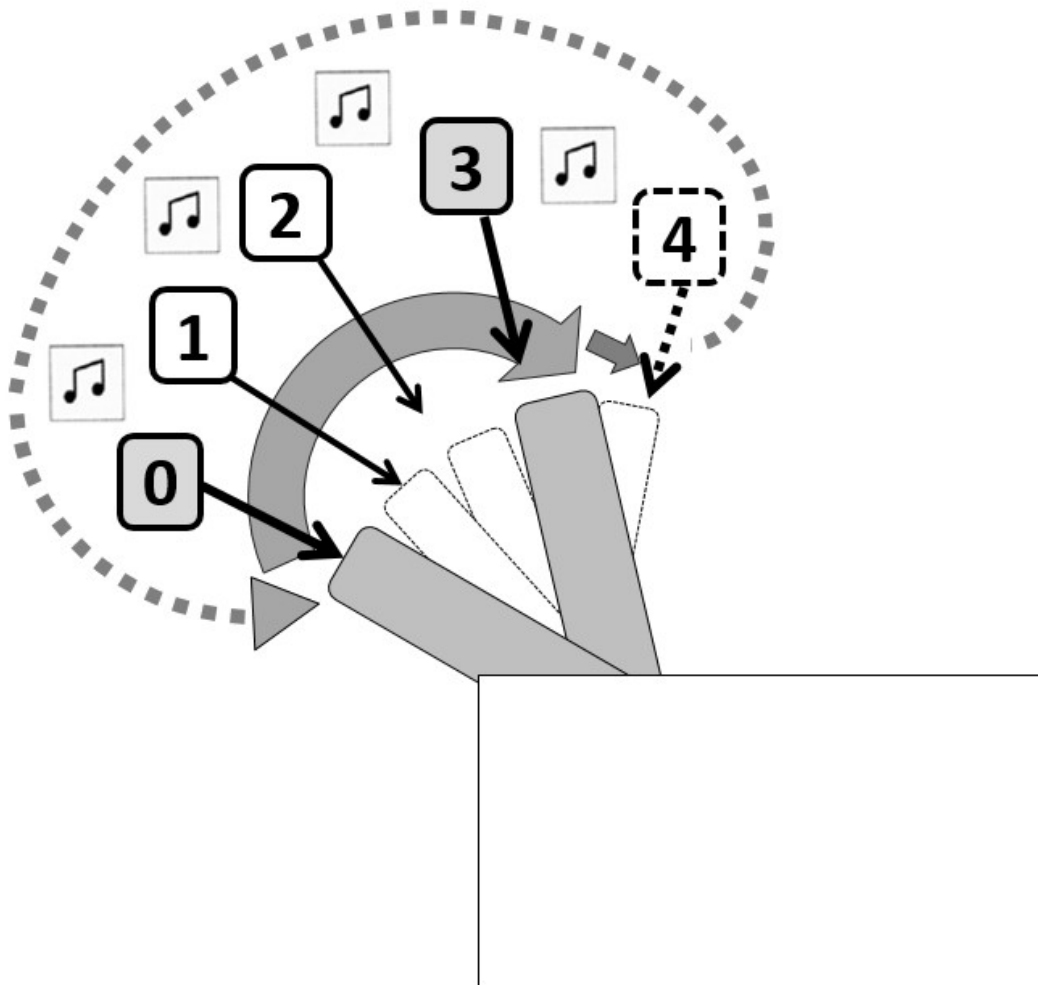
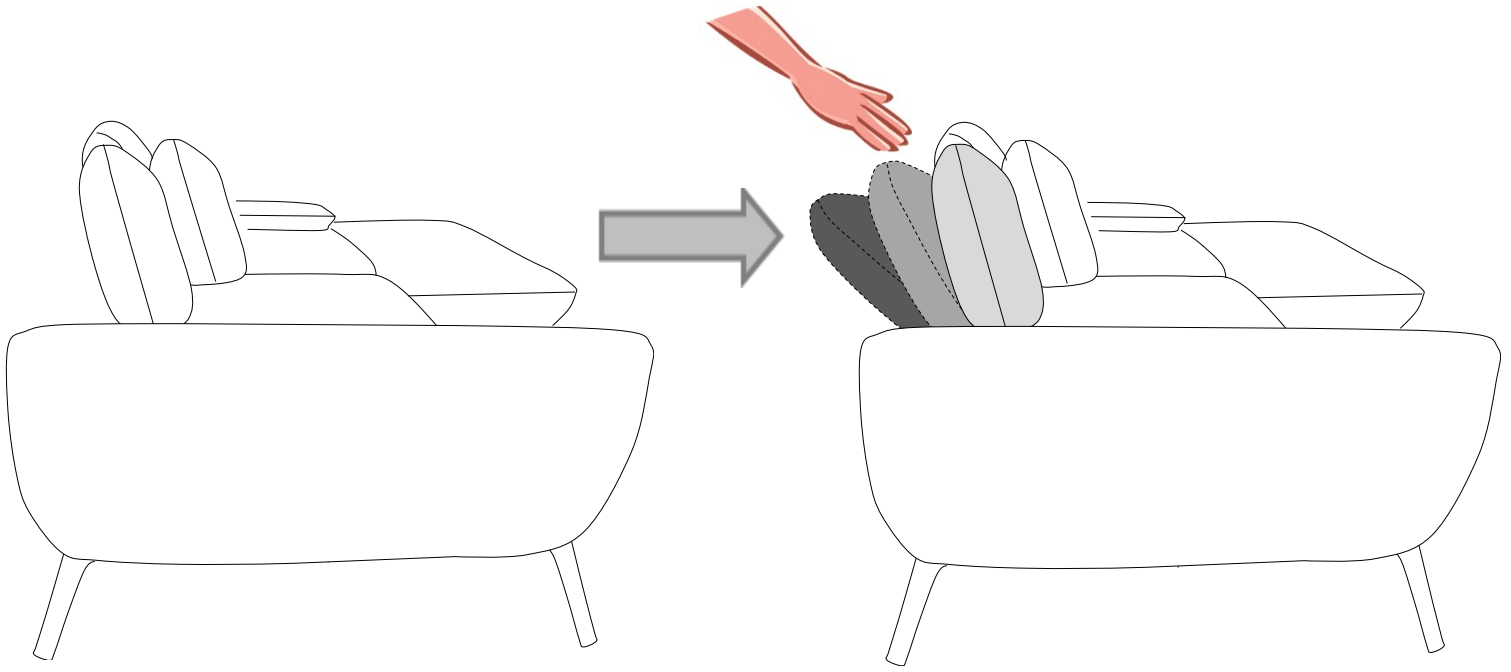

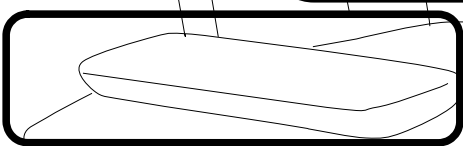
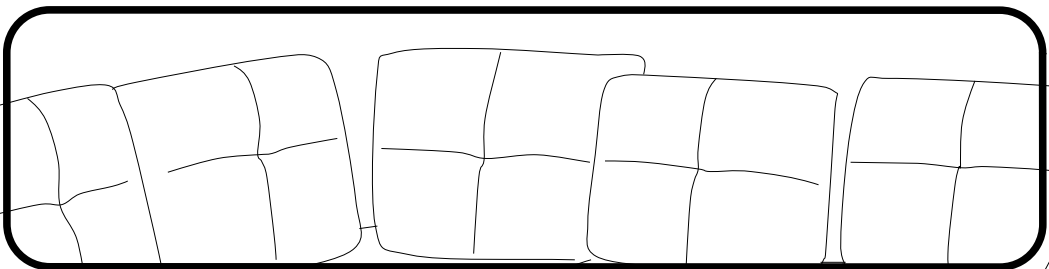
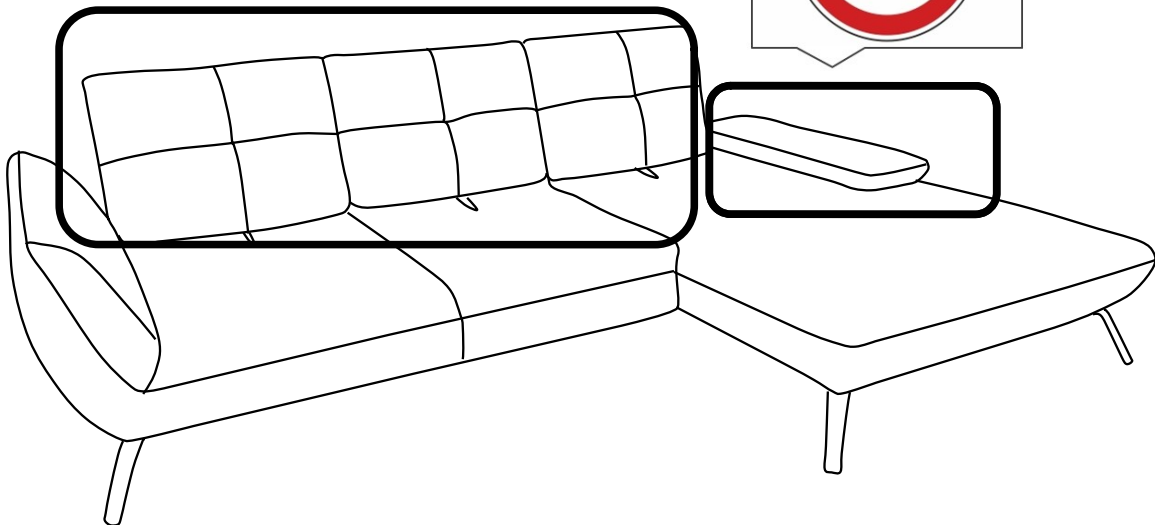
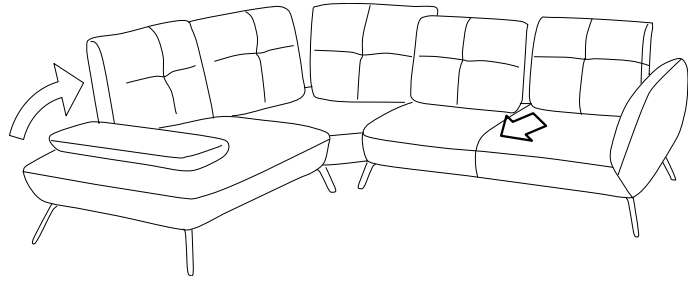
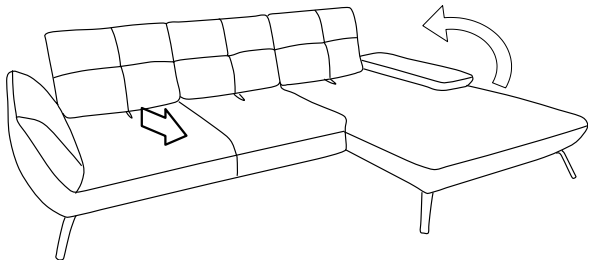

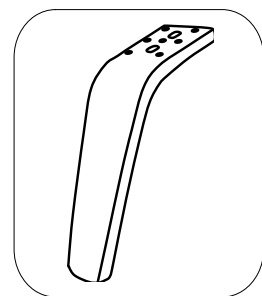
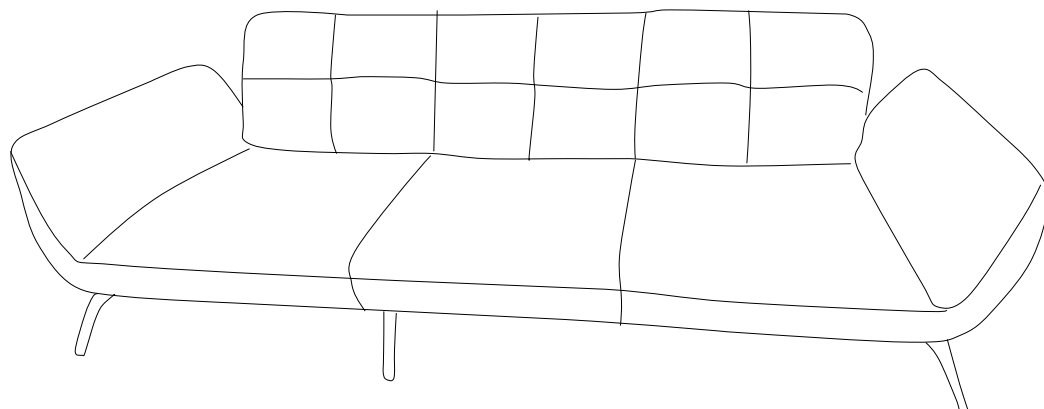
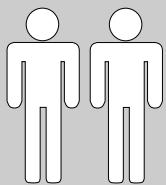

DOVER
VITO TICONA
TRENDY
SEATTLE
ALPHA
BETA

V.03.- 07.09.2023

D MONTAGEANLEITUNG
BEDIENUNGSANLEITUNG

NL HANDLEIDING VOOR DE MONTAGE
GEBRUIKSAANWIJZING

TR MONTAJ TALIMATI
KULLANIM KLAVUZU

RO INSTRUCȚIUNI DE INSTALARE
INSTRUCȚIUNI DE UTILIZARE

FR NOTICE DE MONTAGE
MANUEL INSTRUCTIONS

HU KÖZGYŰLÉS UTASÍTÁSOK
KEZELÉSI UTASÍTÁS

SI NAVODILA ZA MONTAŽO
NAVODILA ZA UPORABO

ES INSTRUCCIONES DE MONTAJE
MANUAL DEL USUARIO

GB ASSEMBLY INSTRUCTIONS
INSTRUCTION MANUAL

PL INSTRUKCJA MONTAŻU
INSTRUKCJA OBSŁUGI

RU ИНСТРУКЦИЯ ПО МОНТАЖУ
ИНСТРУКЦИЯ ПО ЭКСПЛУАТАЦИИ

IT ISTRUZIONI DI MONTAGGIO
MANUALE DI ISTRUZIONI

SK MONTÁŽNY NÁVOD
NÁVOD NA POUŽITIE

CZ MONTÁŽNÍ NÁVOD
NÁVOD K POUŽITÍ

PT INSTRUÇÕES DE MONTAGEM
MANUAL DO USUÁRIO

HR UPUTE ZA MONTAŽU
UPUTE ZA UPOTREBU





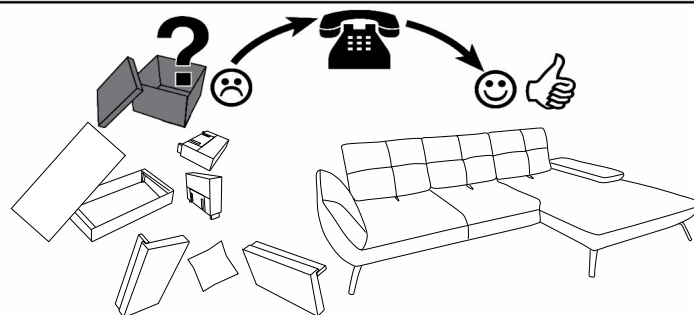
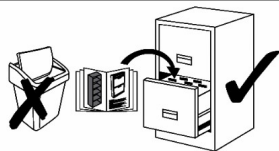

Service · Dienstverlening · Serwis · Servis · Сервисная служба · Serviciu ·
Services · Servizio · Servisný list · Szolgáltatás · Servisní list

Name · Naam · Nazwa · İsim · Название · Nume · Nome ·
Názov · Názov · Název · Neve

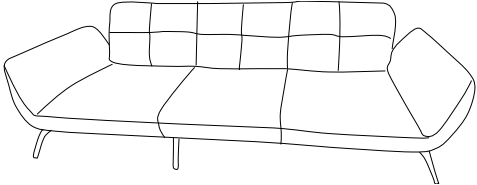
DOVER / VITO TICONA / TRENDY / SEATTLE / ALPHA

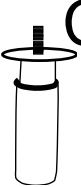
Тип · Type · Tip · Тип · Tipo · Típus

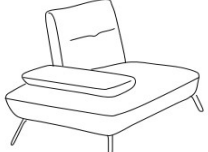

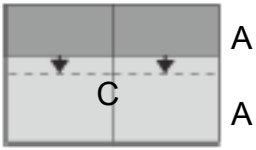
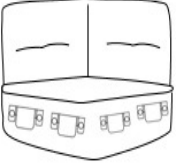
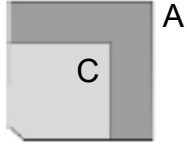
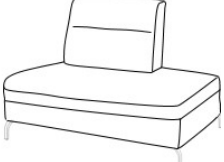
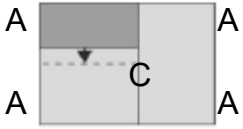
✓			 A = a1	 B M6x25	 C	 D L4
	 1100-1300		4 x A 4 x a1	2 x 4B 2 x 2B	/	
	 2000		2 x A 2 x a1	8x	1x	1x
	 5000		1 x A 1 x a1	4x	1x	
	 1051-1053		4 x A 4 x a1	16x	1x	

Zusatzinformation für die Fußmontage

ACHTUNG!

Bitte beachten Sie, dass bei dieser Zusammenstellung
die FüÙe aussen schräg
und die mittleren FüÙe zwischen 1er links und dem 2er gerade
und mit 2 Schrauben montiert werden sollen.

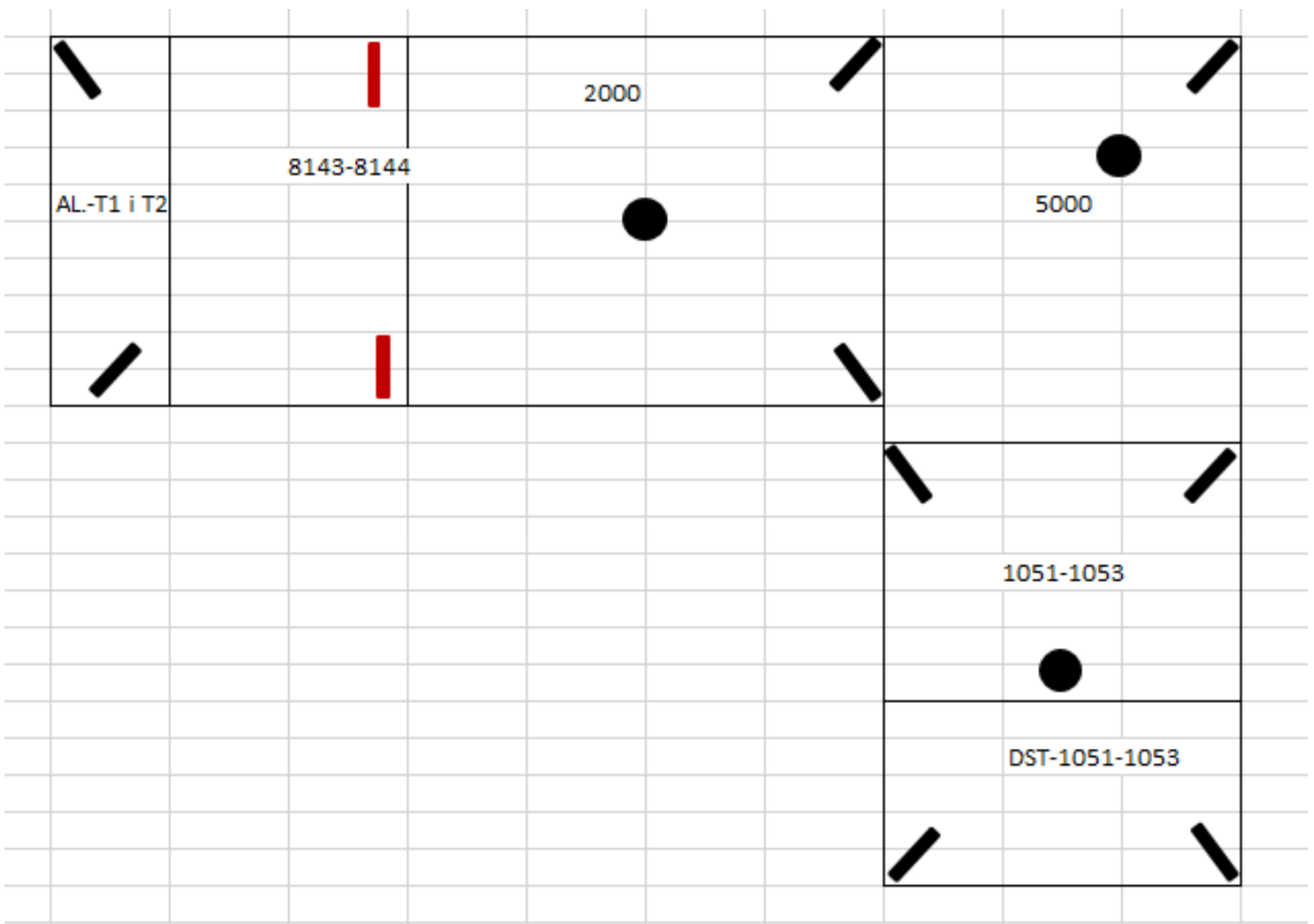

ACHTUNG!

Bitte beachten Sie, dass bei dieser Zusammenstellung die FüÙe aussen schräg und die mittleren FüÙe zwischen 1er links und dem 2er gerade und mit 2 Schrauben montiert werden sollen.

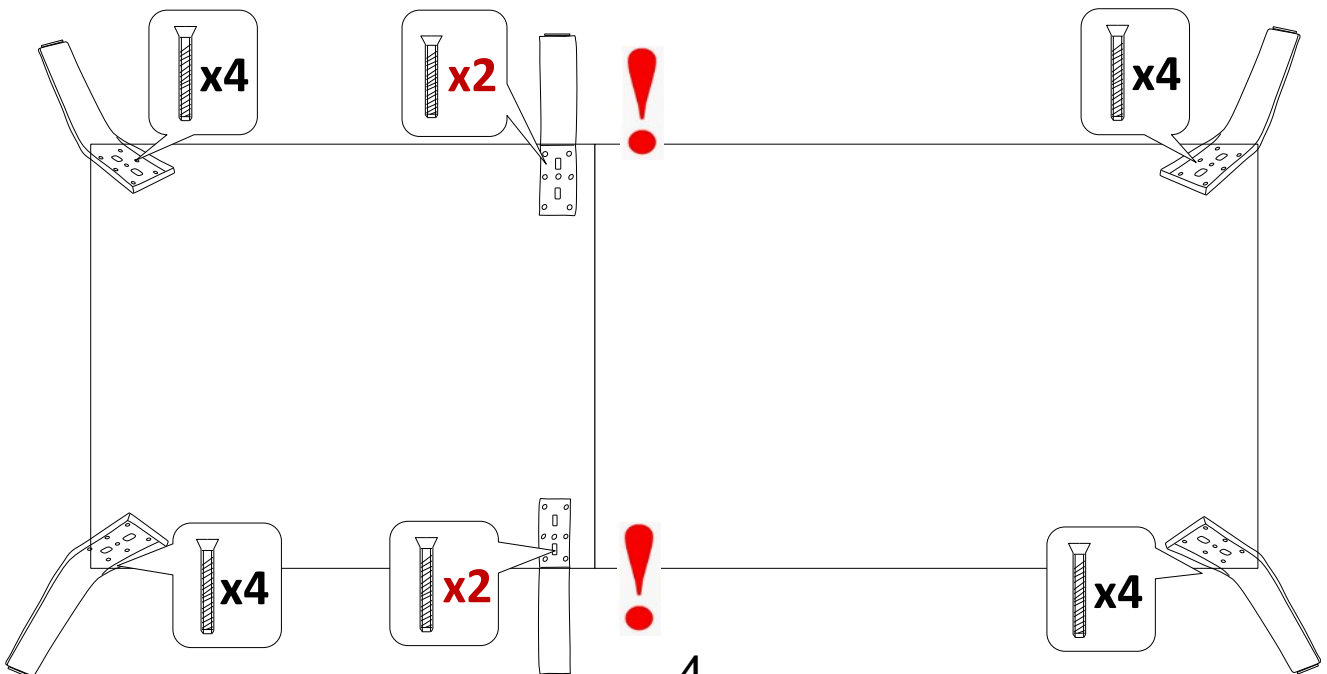
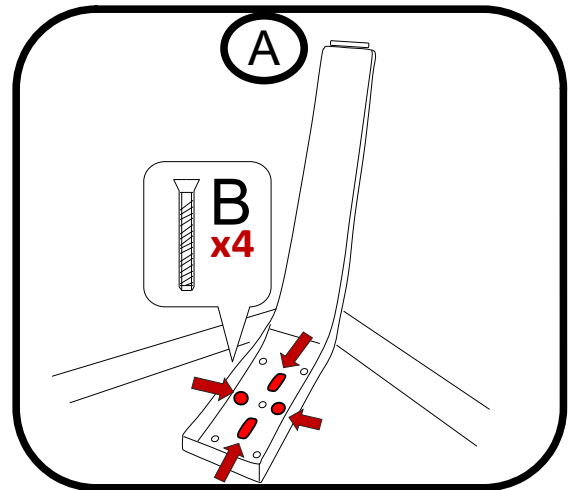
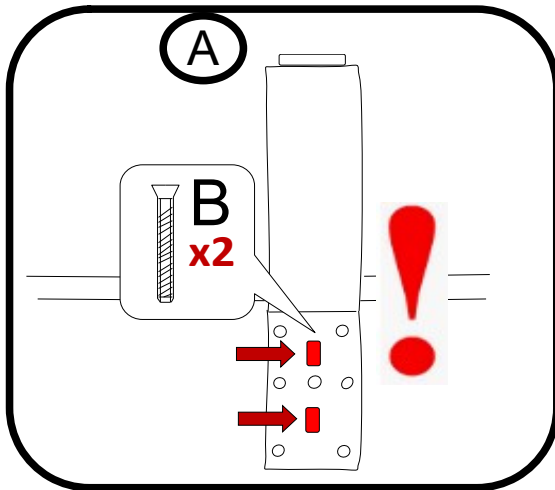
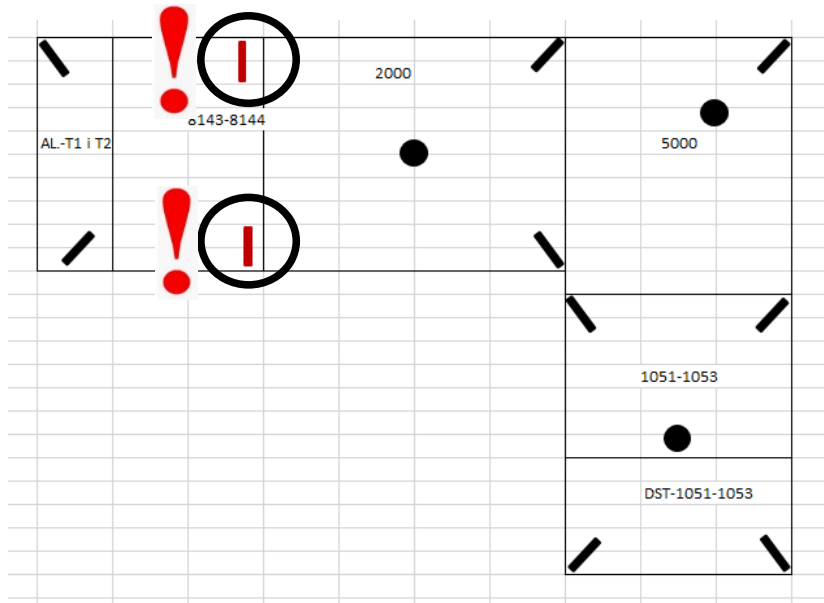

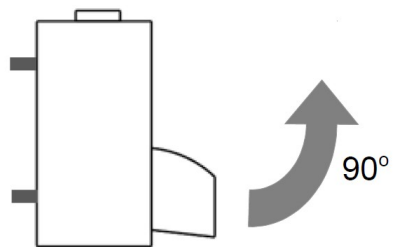
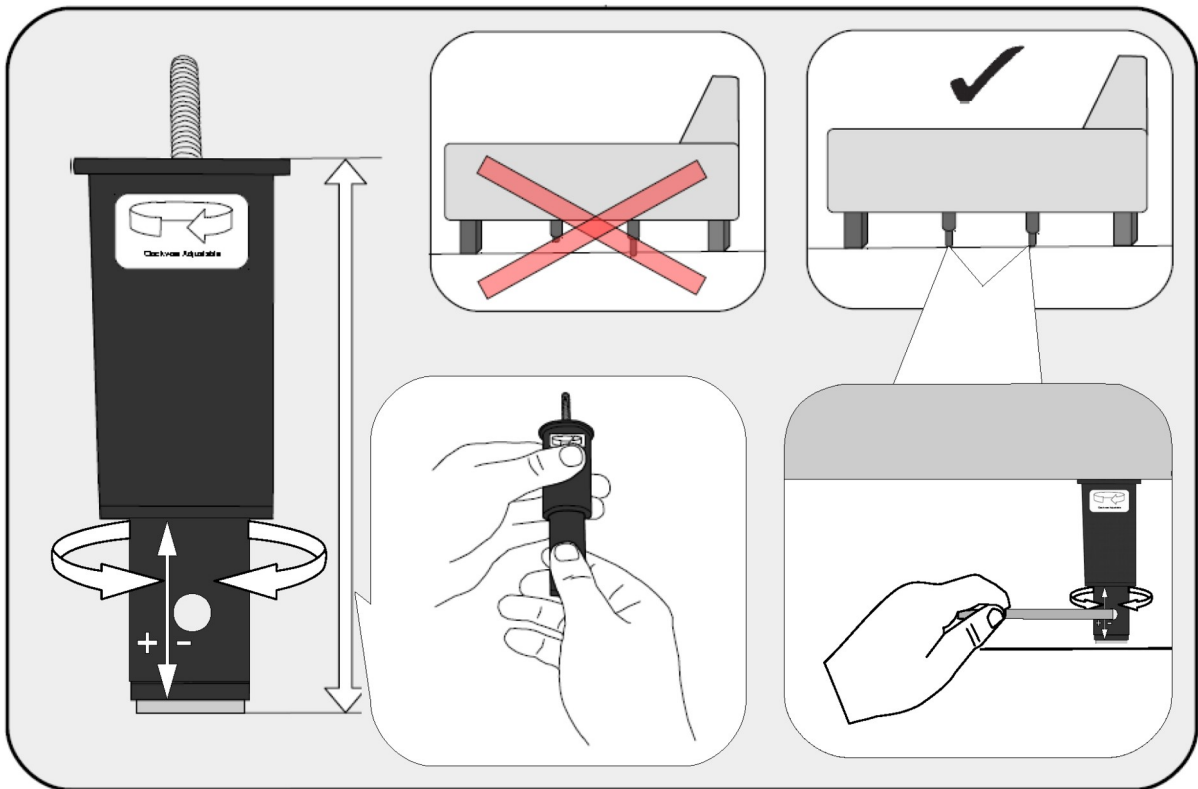
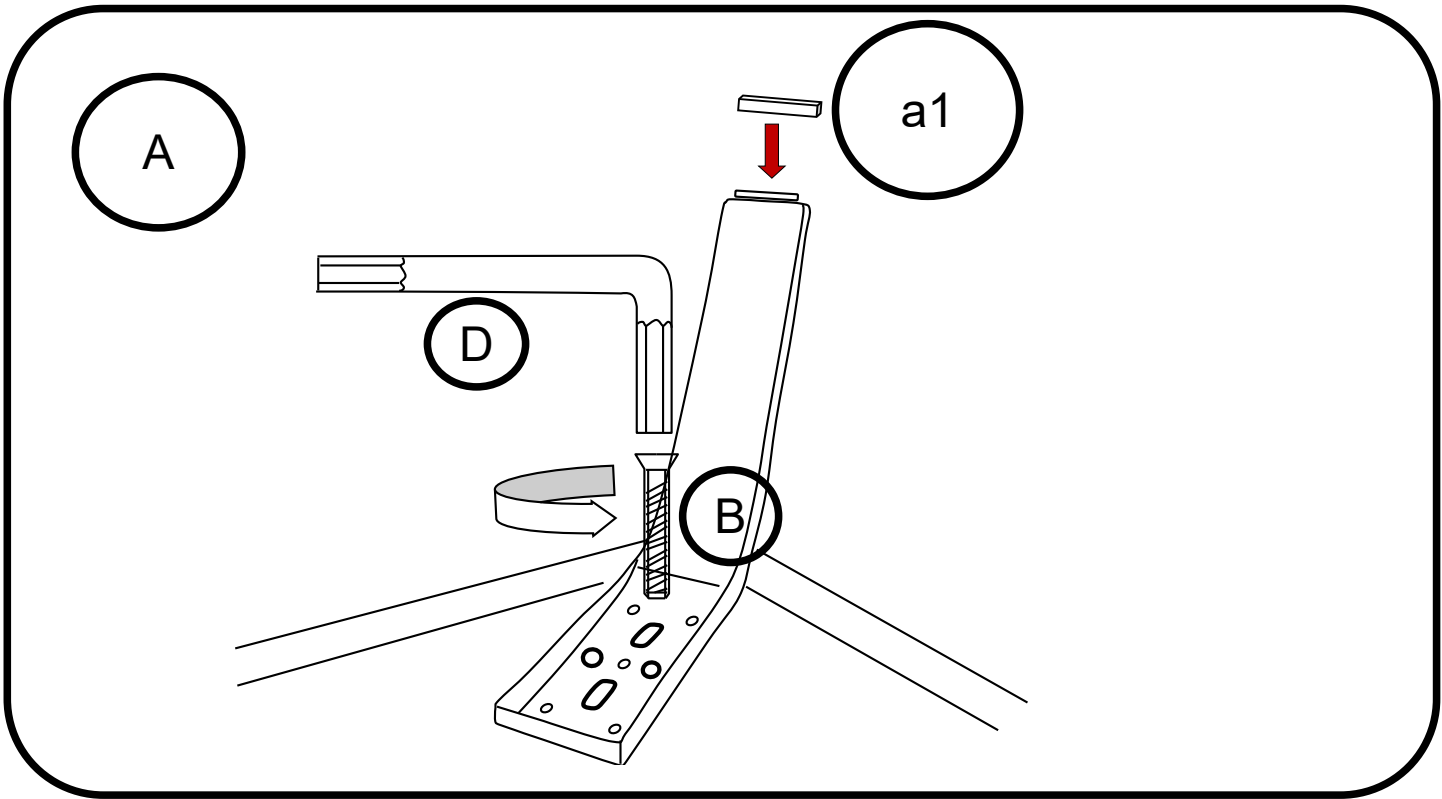
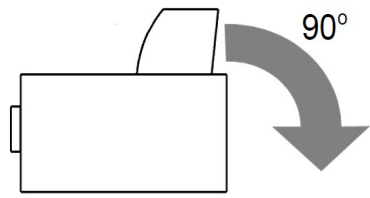

1

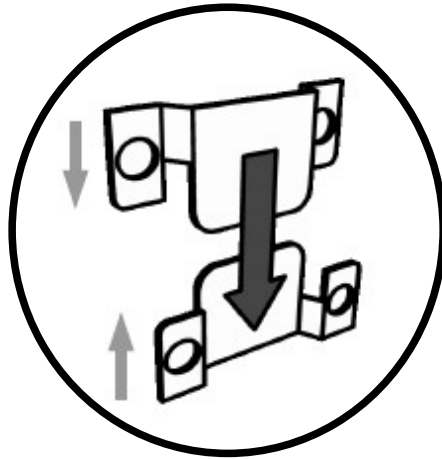
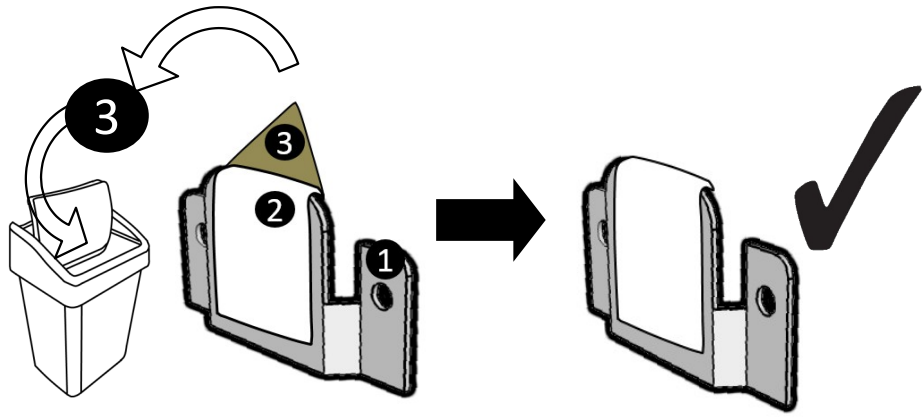

2

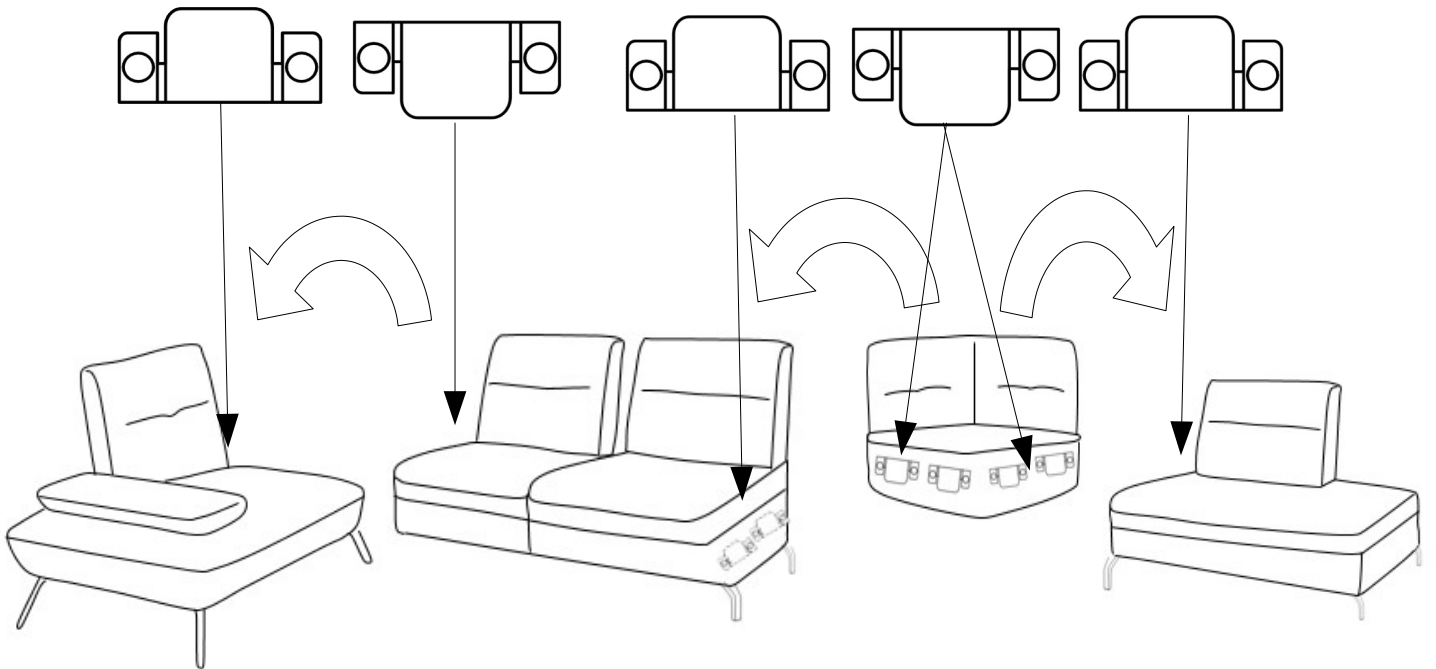

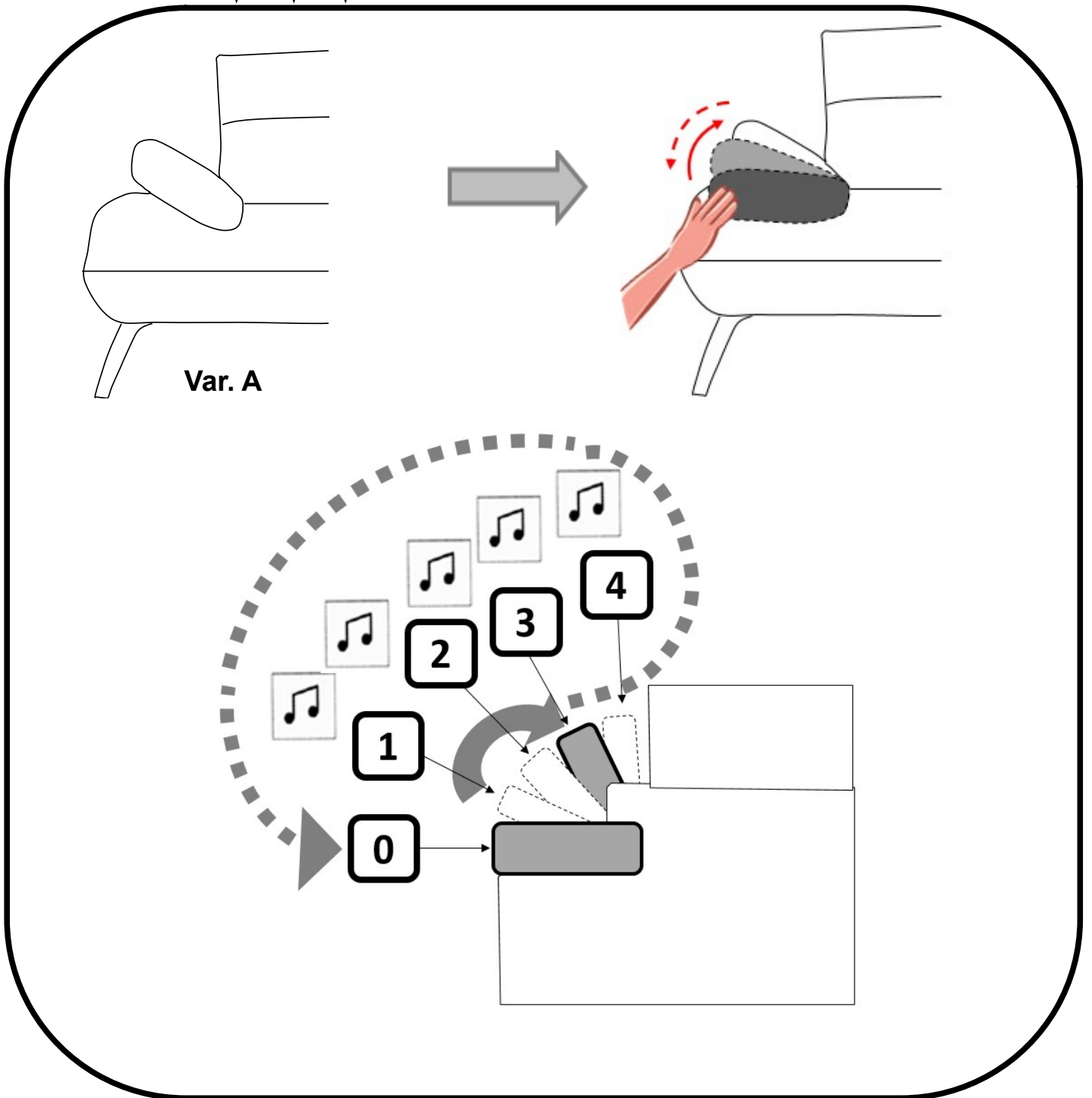
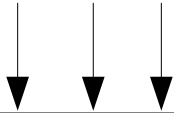
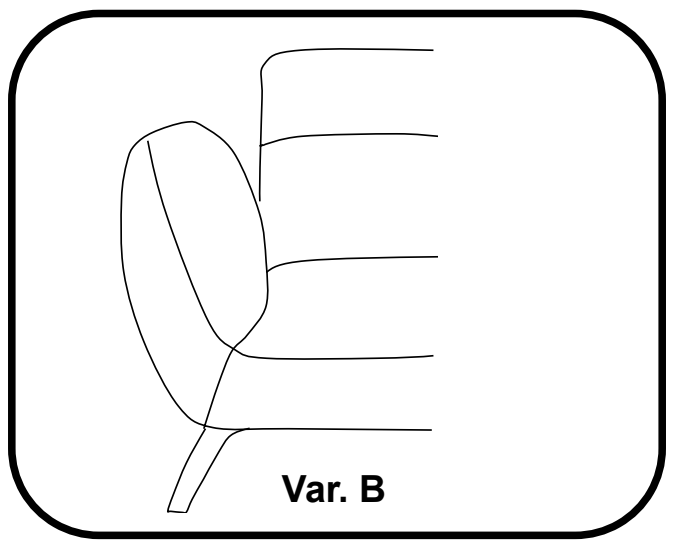
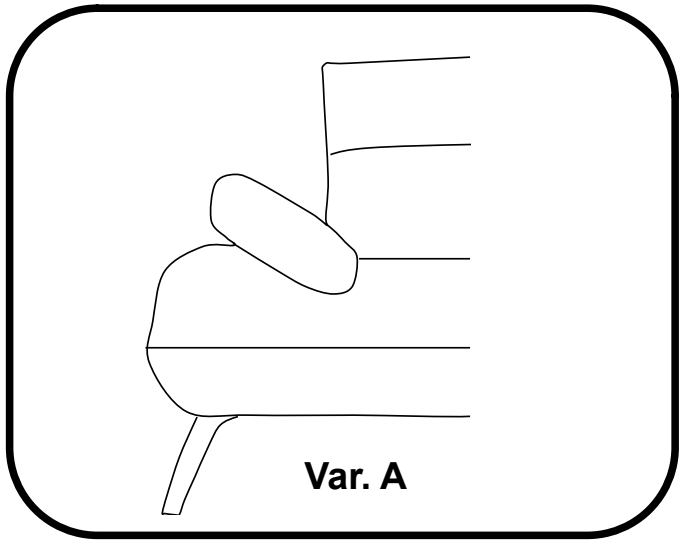

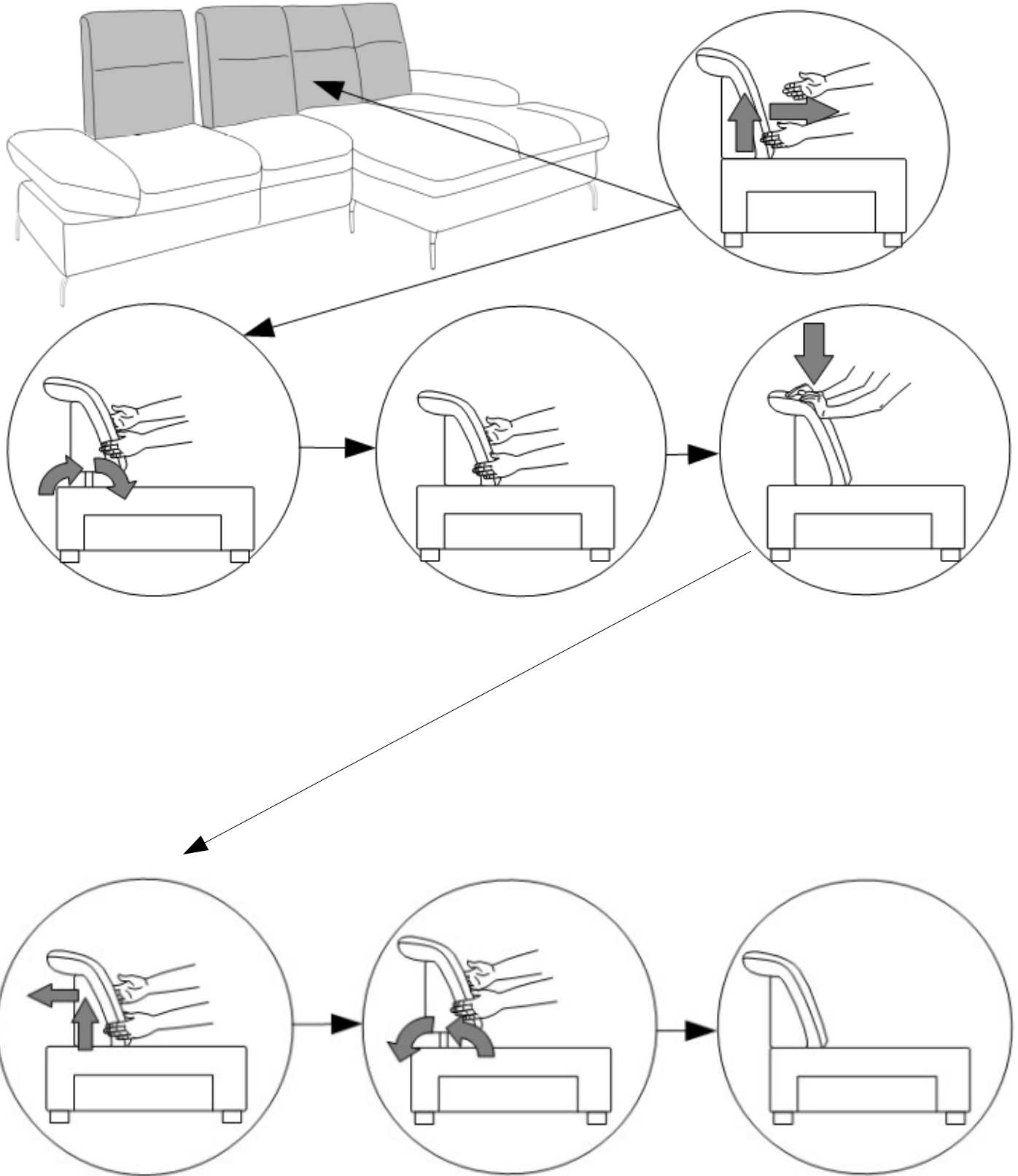
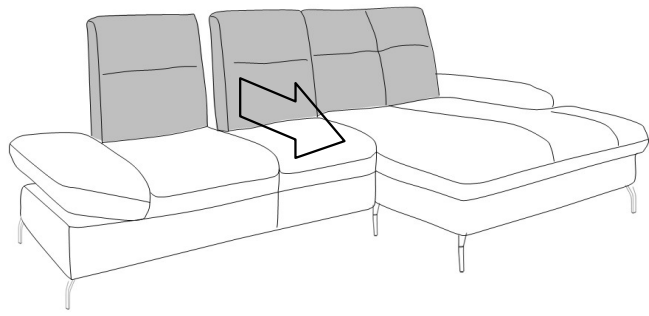

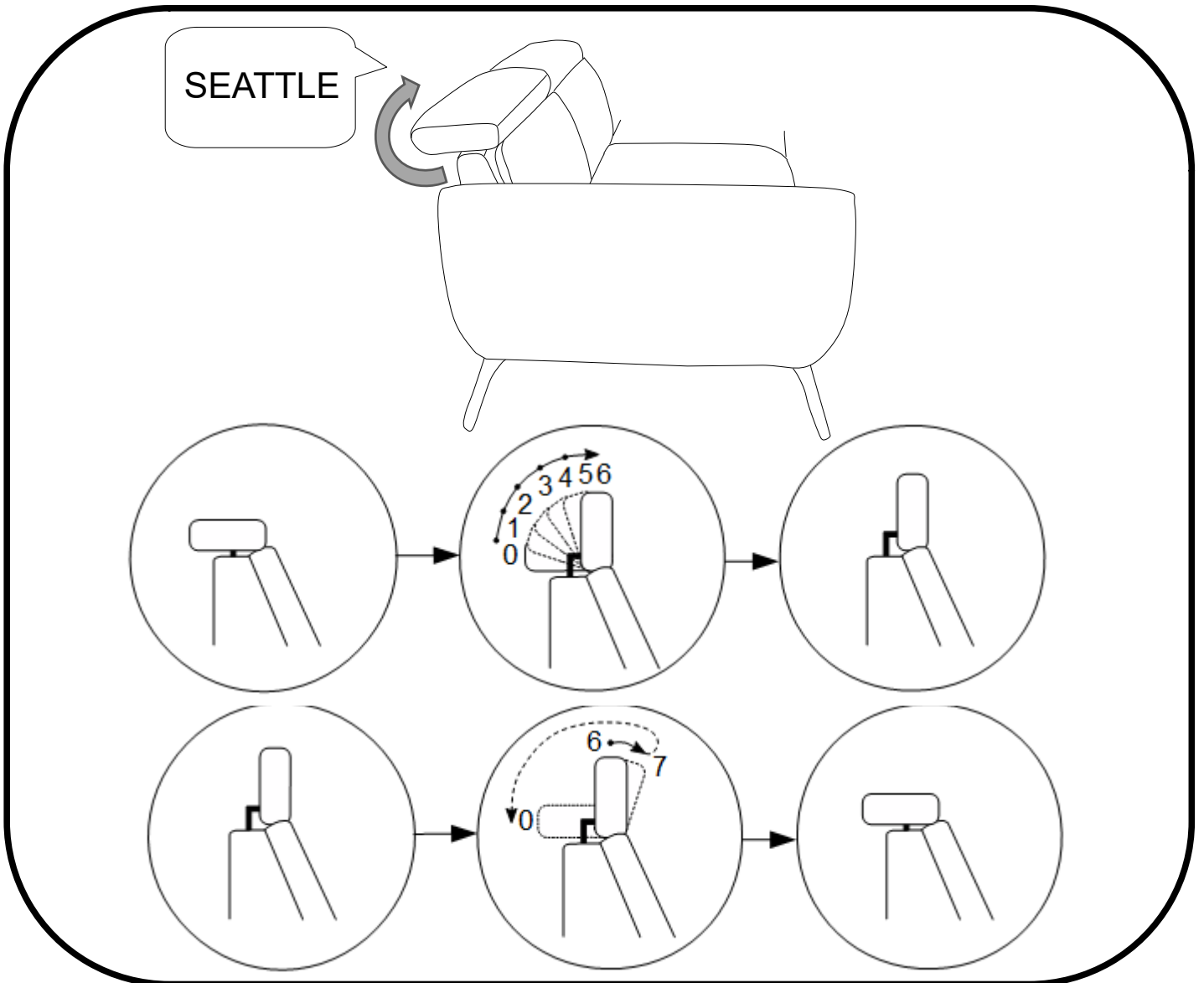
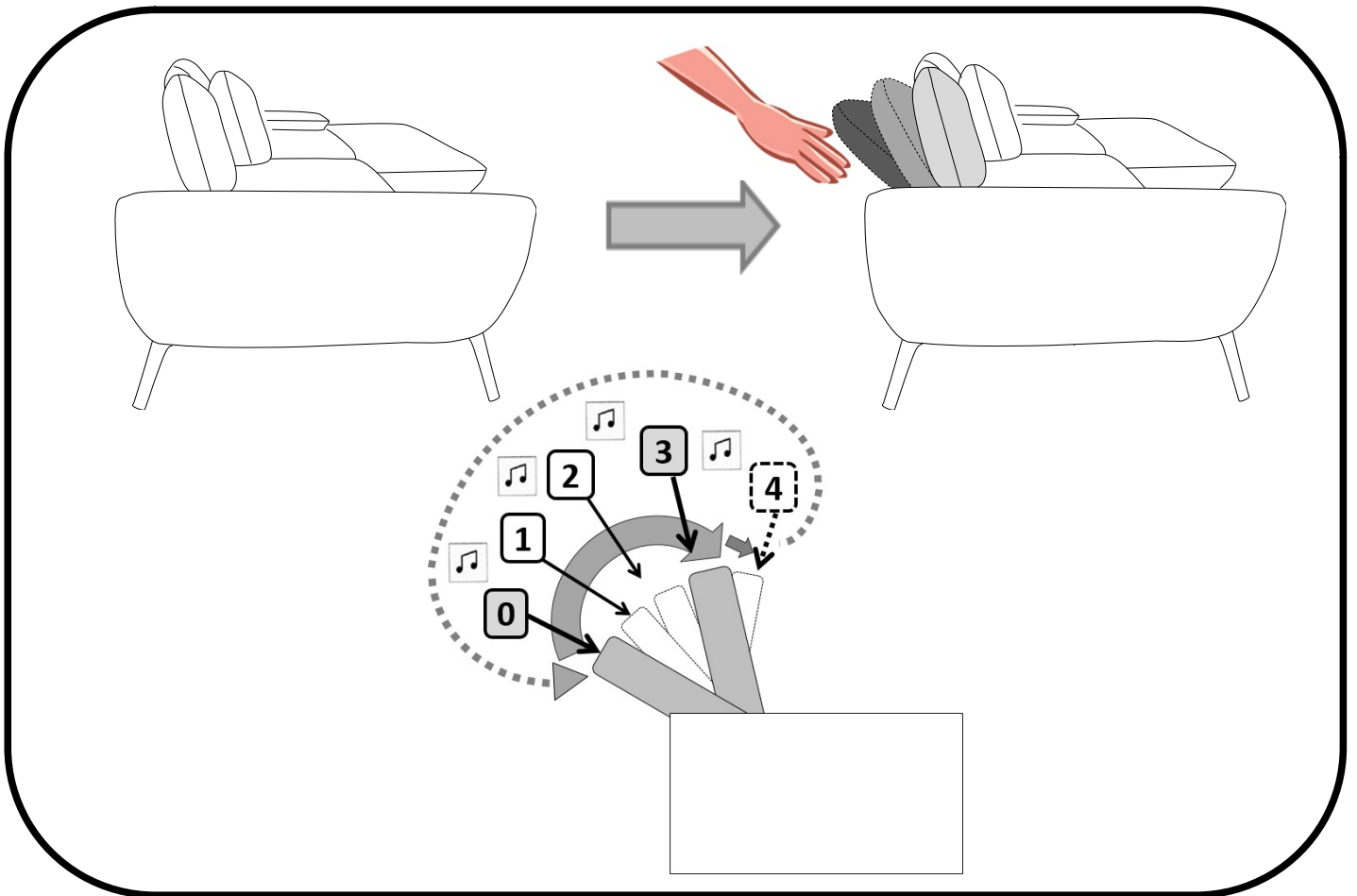

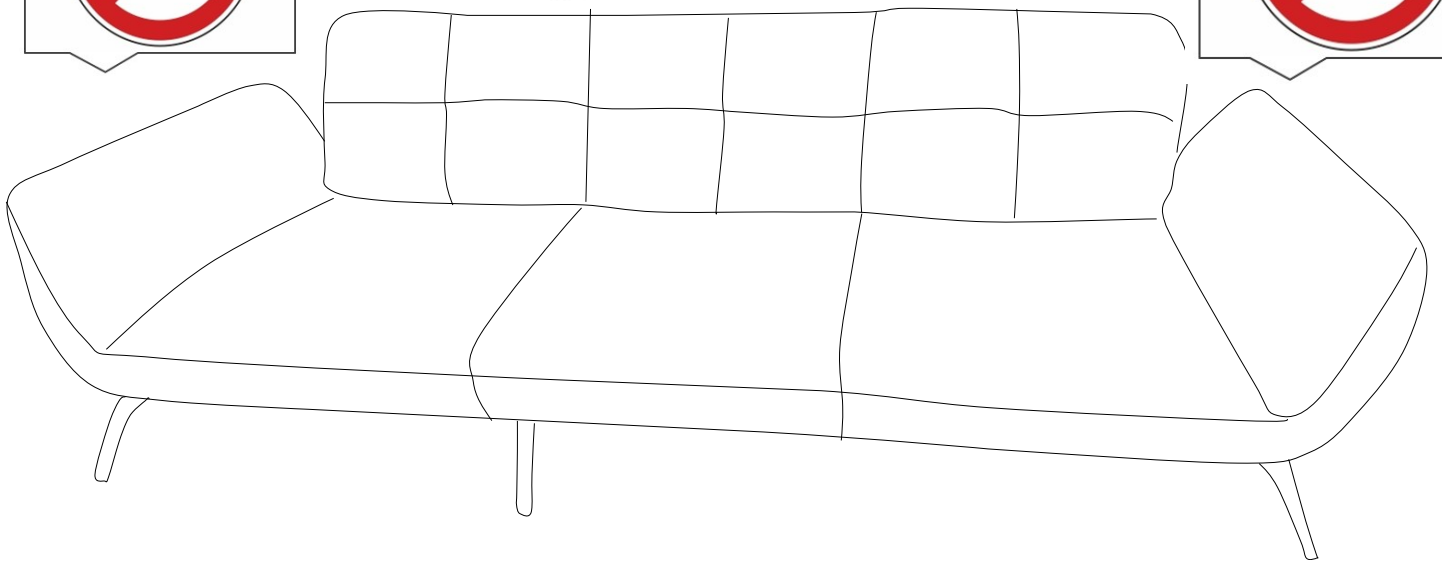

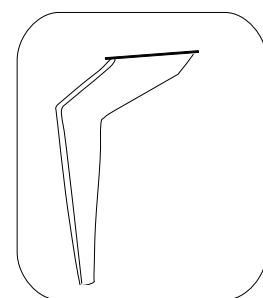
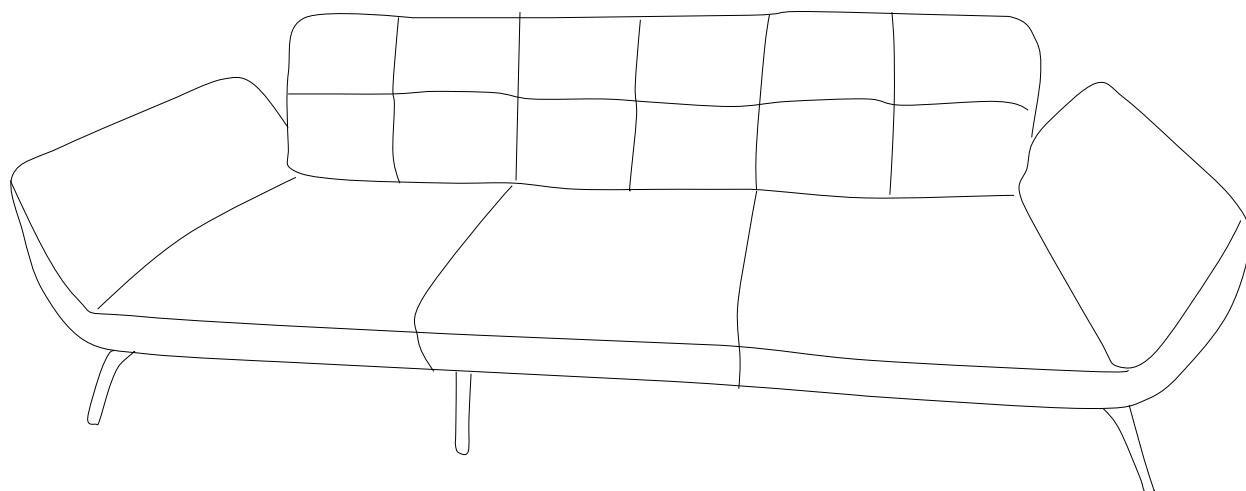
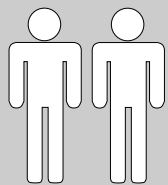

VITO TICONA / PAYTON

V.03.-02.2022

- | | | | |
|-----------|--|-----------|---|
| D | MONTAGEANLEITUNG
BEDIENUNGSANLEITUNG | GB | ASSEMBLY INSTRUCTIONS
INSTRUCTION MANUAL |
| NL | HANDLEIDING VOOR DE MONTAGE
GEBRUIKSAANWIJZING | PL | INSTRUKCJA MONTAŻU
INSTRUKCJA OBSŁUGI |
| TR | MONTAJ TALIMATI
KULLANIM KLAVUZU | RU | ИНСТРУКЦИЯ ПО МОНТАЖУ
ИНСТРУКЦИЯ ПО ЭКСПЛУАТАЦИИ |
| RO | INSTRUCȚIUNI DE INSTALARE
INSTRUCȚIUNI DE UTILIZARE | IT | ISTRUZIONI DI MONTAGGIO
MANUALE DI ISTRUZIONI |
| FR | NOTICE DE MONTAGE
MANUEL INSTRUCTIONS | SK | MONTÁŽNY NÁVOD
NÁVOD NA POUŽITIE |
| HU | KÖZGYŰLÉS UTASÍTÁSOK
KEZELÉSI UTASÍTÁS | CZ | MONTÁŽNÍ NÁVOD
NÁVOD K POUŽITÍ |
| SI | NAVODILA ZA MONTAŽO
NAVODILA ZA UPORABO | PT | INSTRUÇÕES DE MONTAGEM
MANUAL DO USUÁRIO |
| ES | INSTRUCCIONES DE MONTAJE
MANUAL DEL USUARIO | HR | UPUTE ZA MONTAŽU
UPUTE ZA UPOTREBU |

Service · Dienstverlening · Serwis · Servis · Сервисная служба · Serviciu ·
Services · Servizio · Servisný list · Szolgáltatás · Servisní list

Name · Naam · Nazwa · Ísim · Название · Nume · Nome ·
Názov · Názov · Název · Neve

VITO TICONA / PAYTON

Typ · Type · Tip · Тип · Tipo · Típus

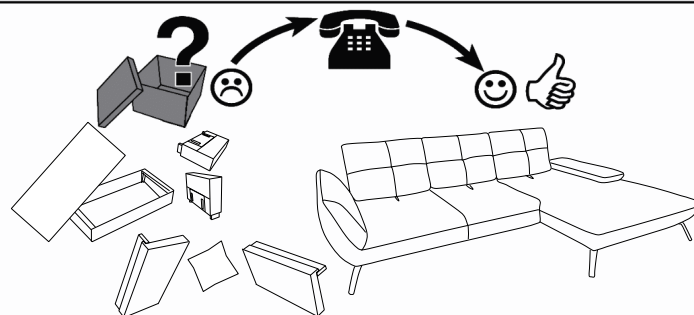
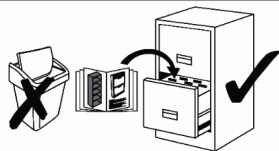

✓		A	B	C	D	
		2 x A 2 x a1	2x3B	1x		
		4 x A 4 x a1	2x4B + 2x3B	1x		
		2 x A 2 x a1	2x3B	2x		
		4 x A 4 x a1	2x4B + 2x3B	2x		1x
		2 x A 2 x a1	2x3B	/		
		4 x A 4 x a1	2x4B + 2x3B	/		
		2 x A 2 x a1	2x3B	1x		
		4 x A 4 x a1	2x4B + 2x3B	1x		

Service · Dienstverlening · Serwis · Servis · Сервисная служба · Serviciu ·
Services · Servizio · Servisný list · Szolgáltatás · Servisní list

Name · Naam · Nazwa · İsim · Название · Nume · Nome ·
Názov · Názov · Název · Neve

VITO TICONA / PAYTON

Typ · Type · Tip · Тип · Tipo · Típus

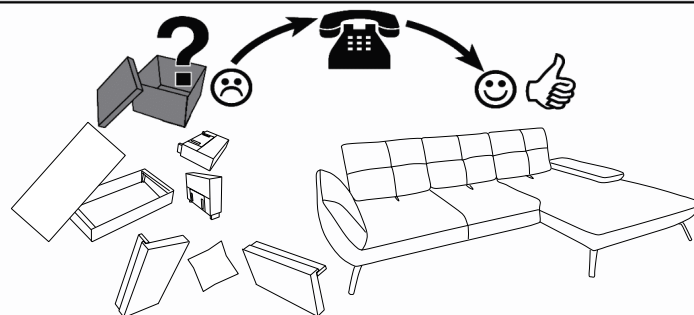
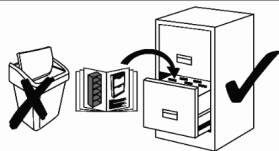

✓					
	 2100-2300		2 x A 2 x a1	2x4B	1x
	 2100-2300		4 x A 4 x a1	4x4B	1x
	 3100-3300		2 x A 2 x a1	2x4B	2x
	 3100-3300		4 x A 4 x a1	4x4B	2x
	 1100-1300		2 x A 2 x a1	2x4B	/
	 1100-1300		4 x A 4 x a1	4x4B	/
	 1051-1053		2 x A 2 x a1	2x4B	1x
	 1051-1053		4 x A 4 x a1	4x4B	1x

Zusatzinformation für die Fußmontage

ACHTUNG!

Bitte beachten Sie, dass bei dieser Zusammenstellung die FüÙe aussen schräg und die mittleren FüÙe gerade montiert werden.

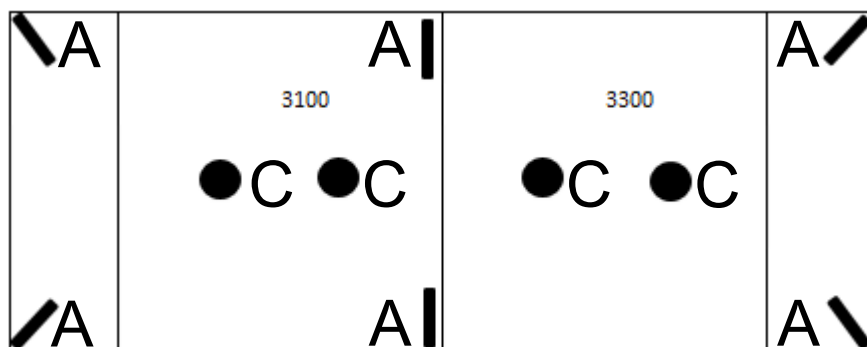
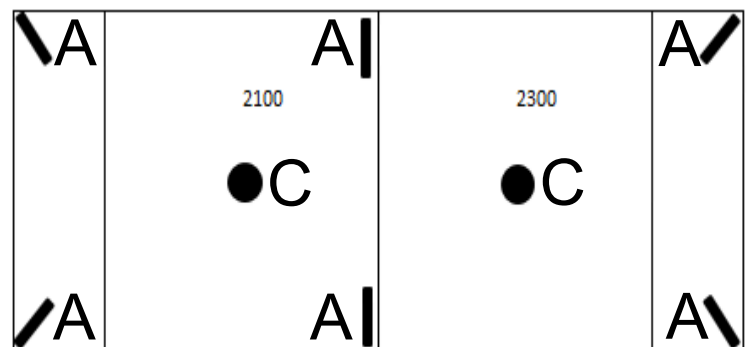
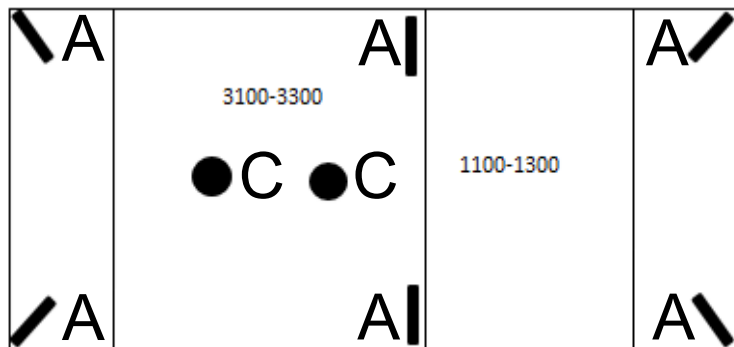
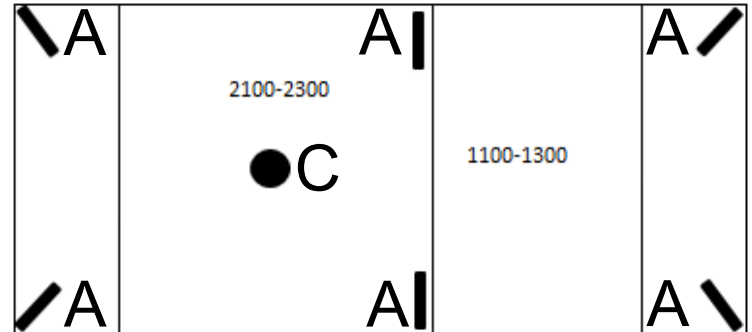
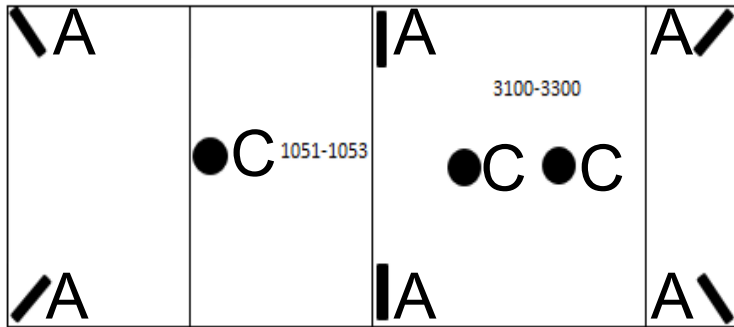
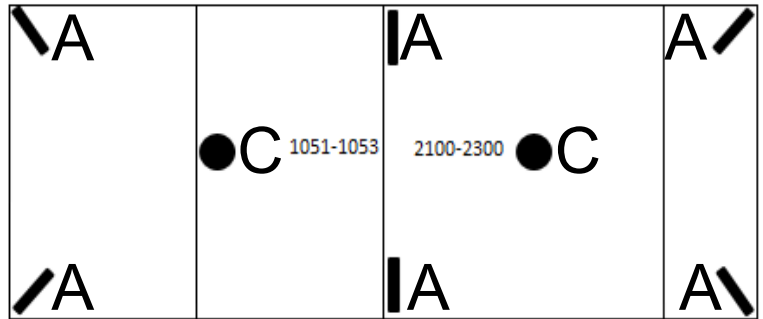
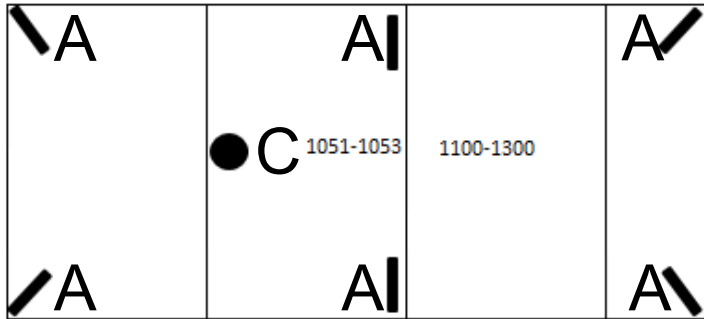

Zusatzinformation für die Fußmontage

ACHTUNG!

Bitte beachten Sie, dass bei dieser Zusammenstellung die FüÙe aussen schräg und die mittleren FüÙe gerade montiert werden.

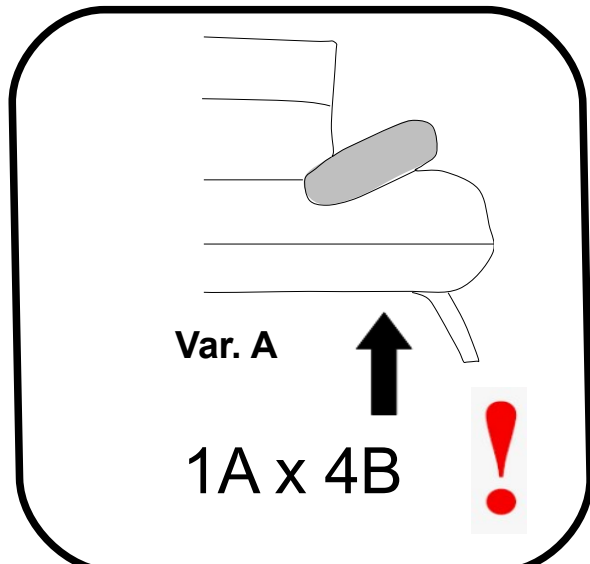
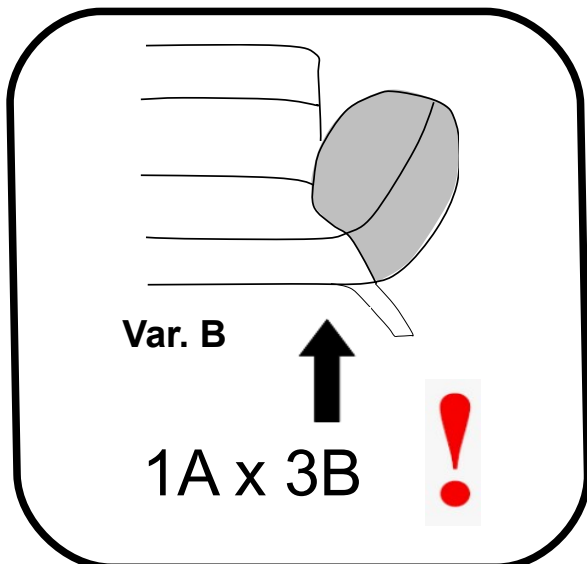
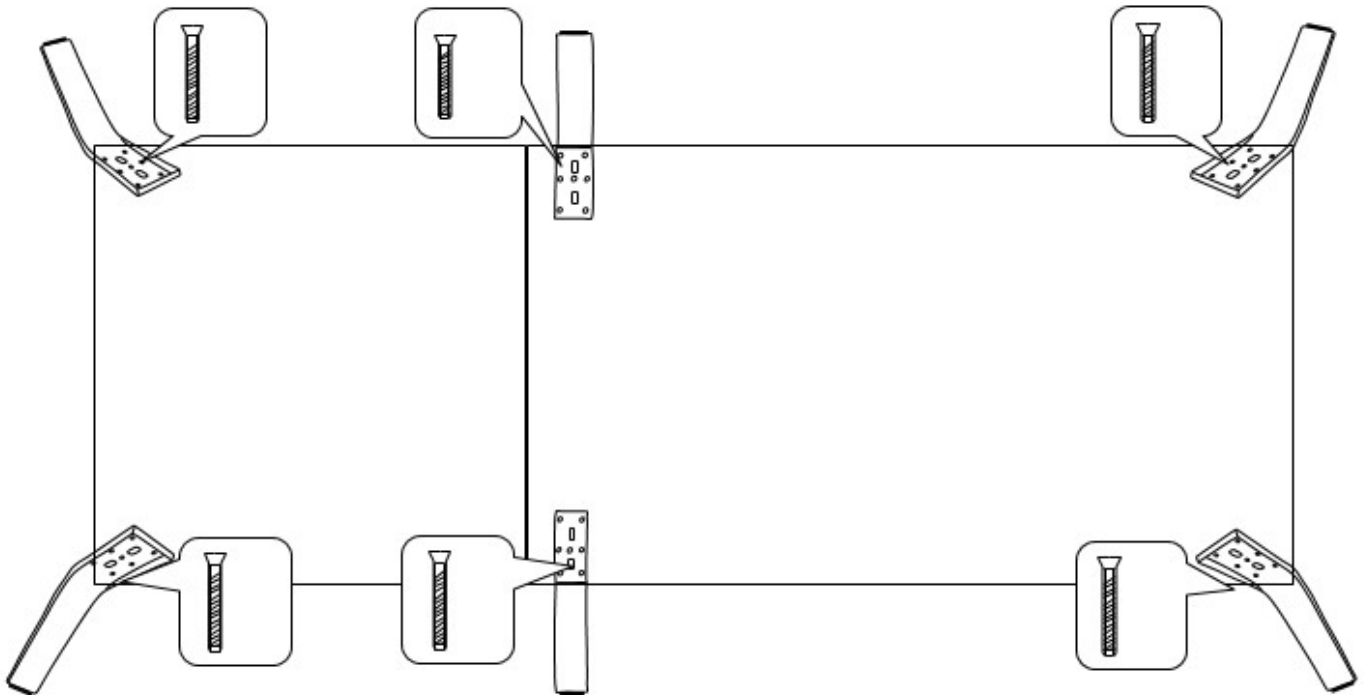
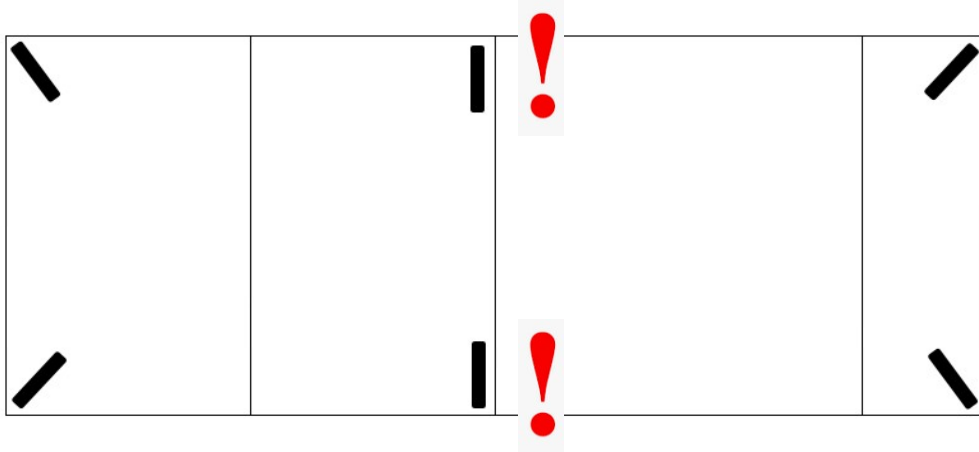

1

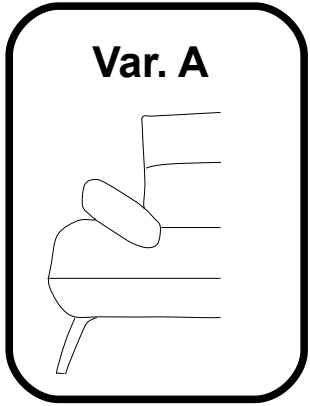
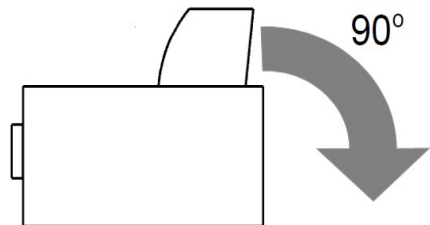

A

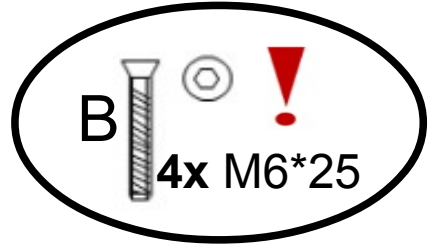

a1

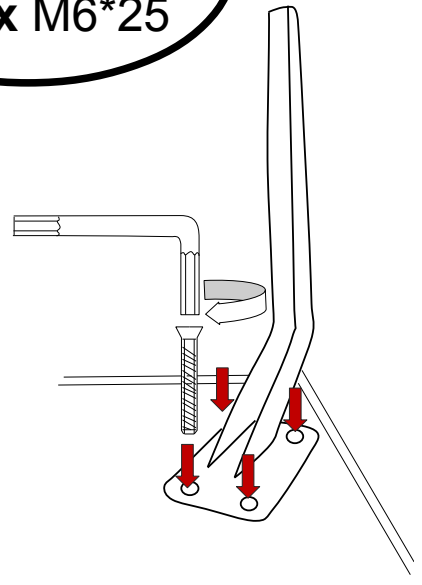
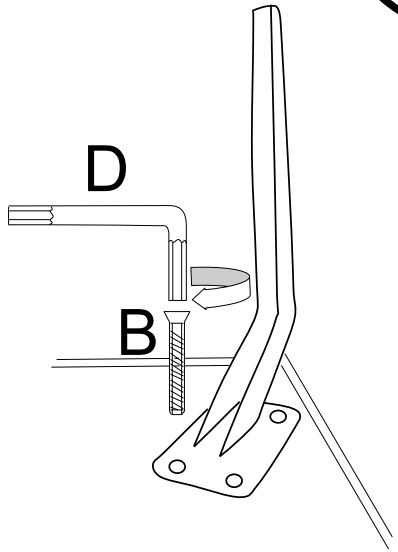

2

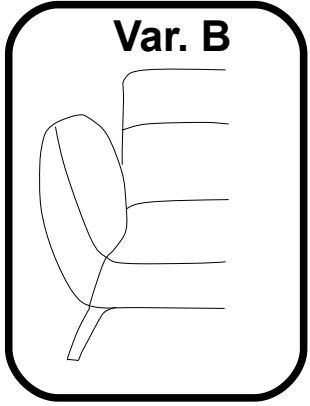

A



a1

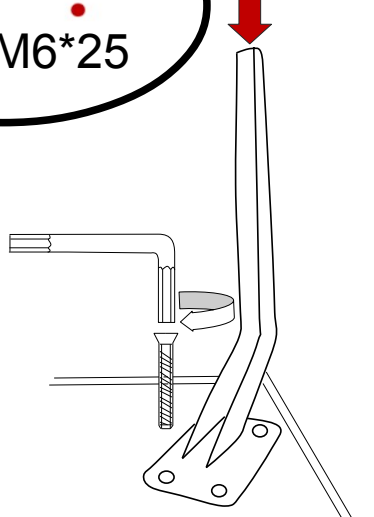
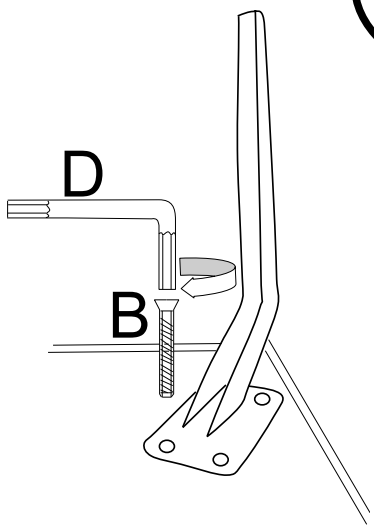

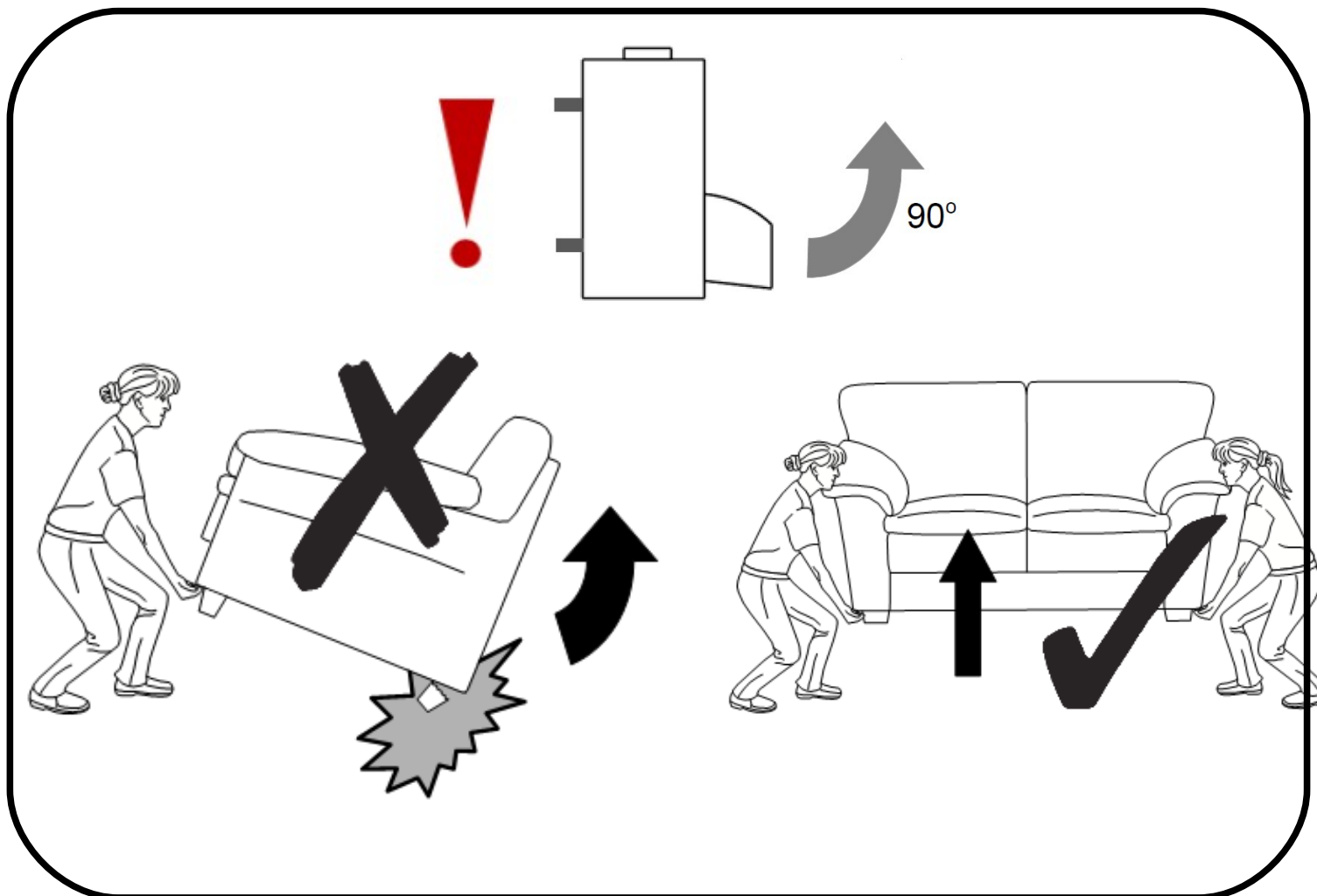
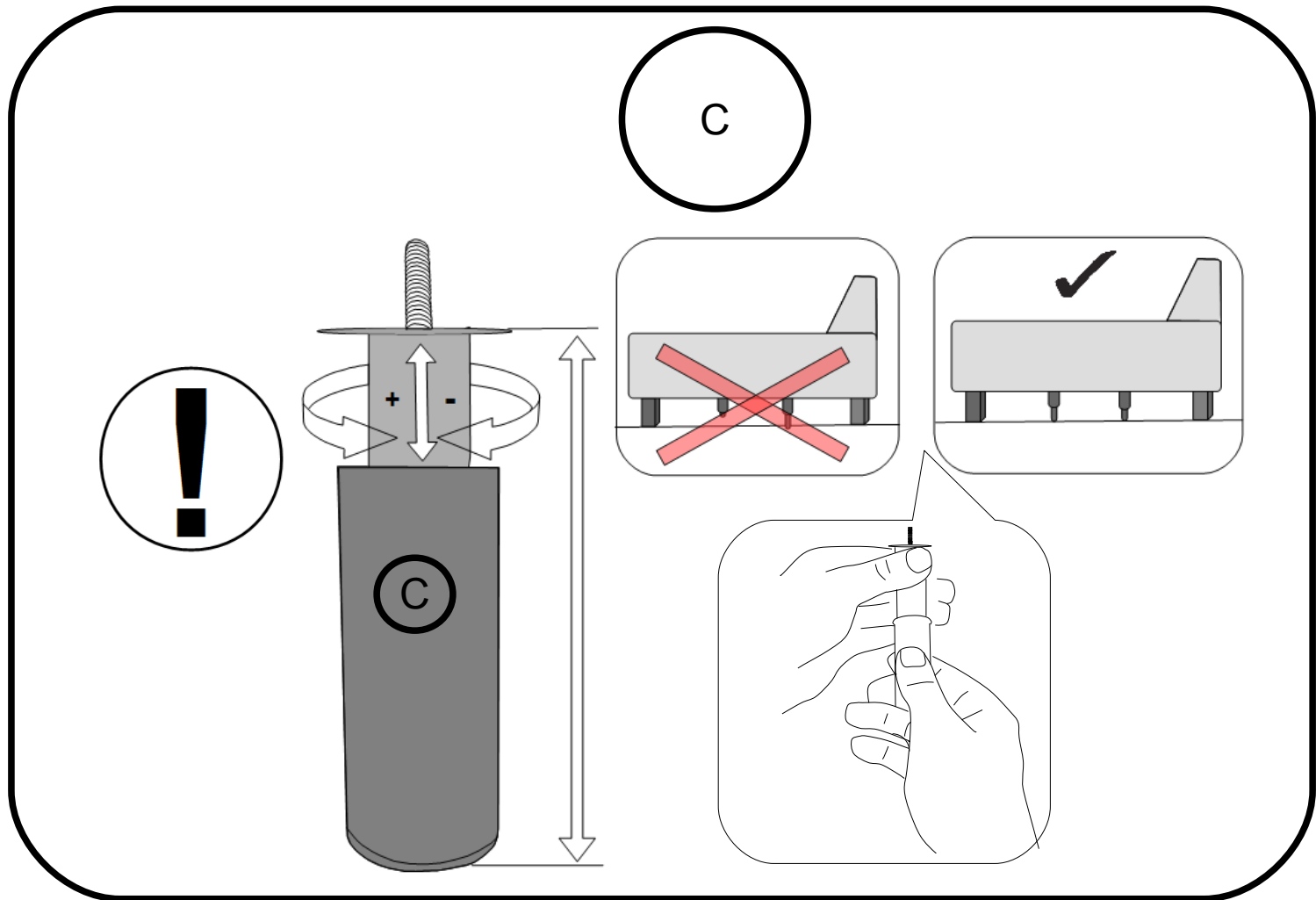

1

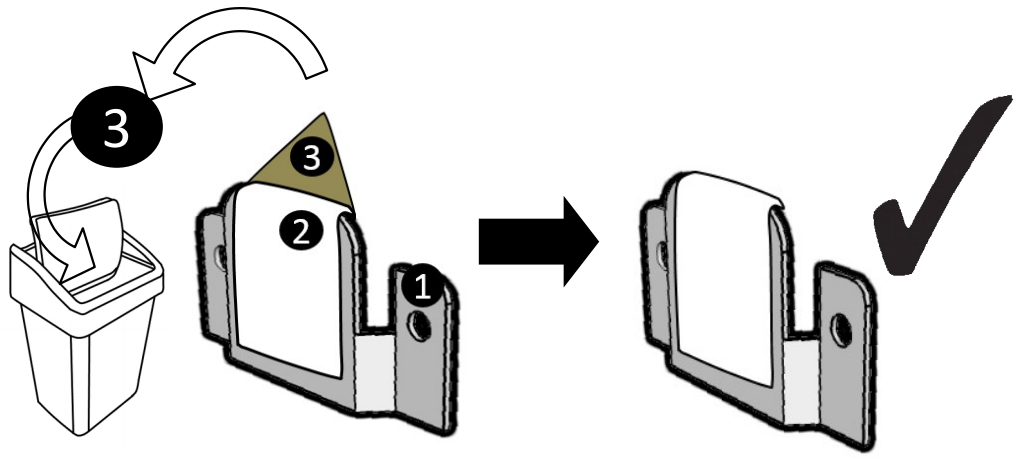

2

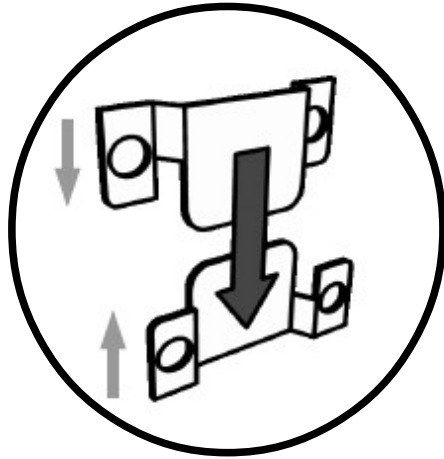

3

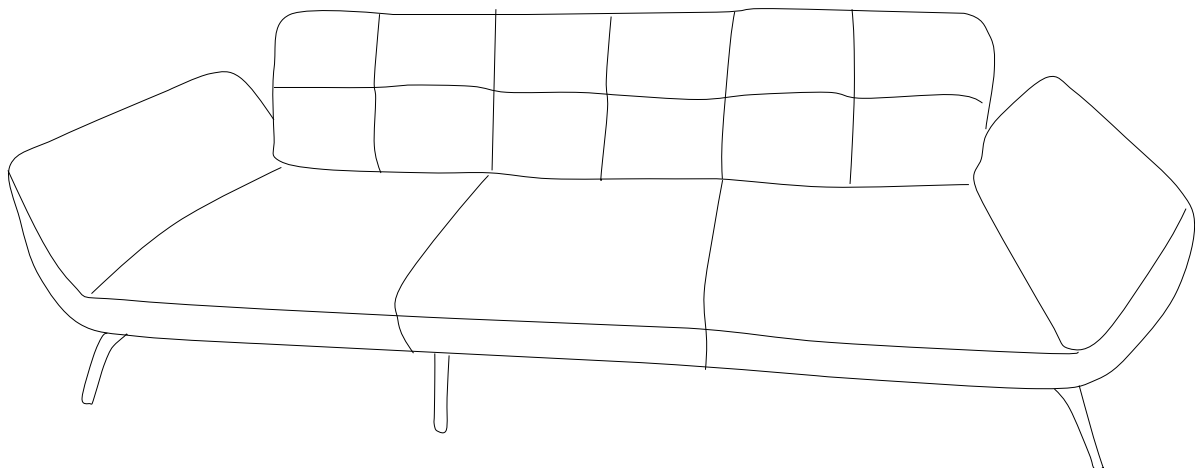
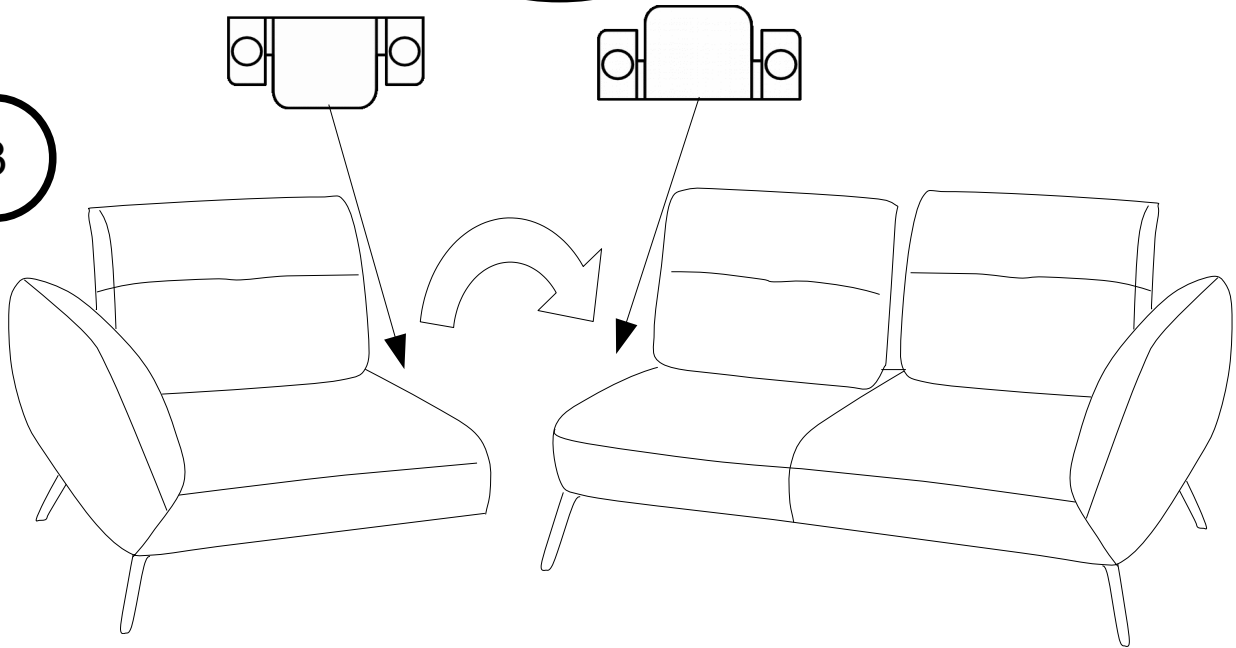

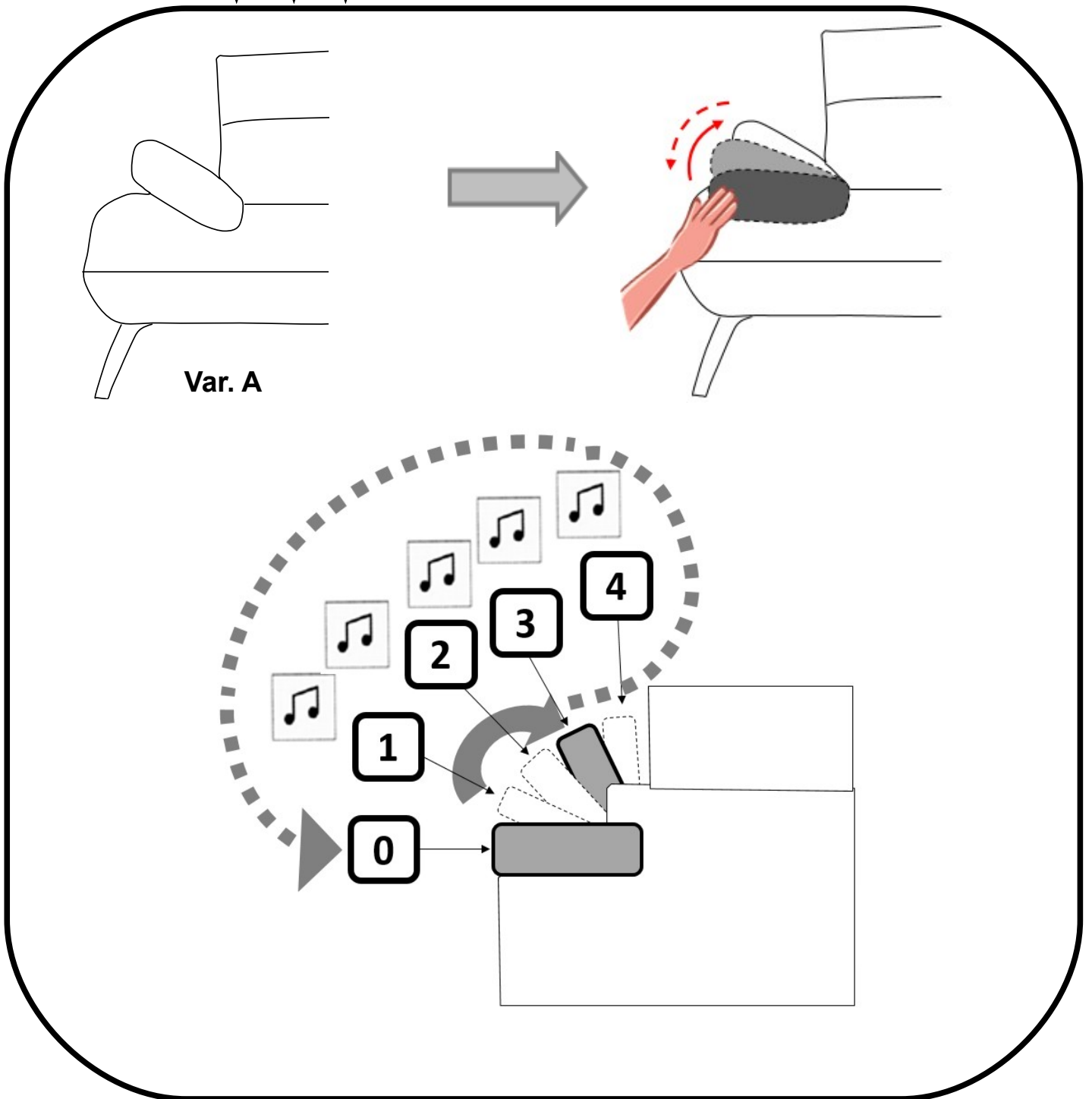
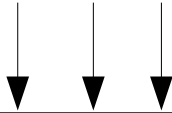
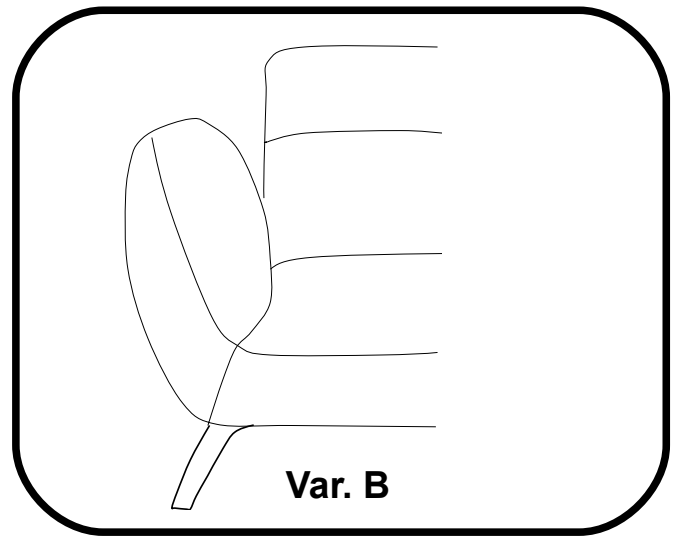
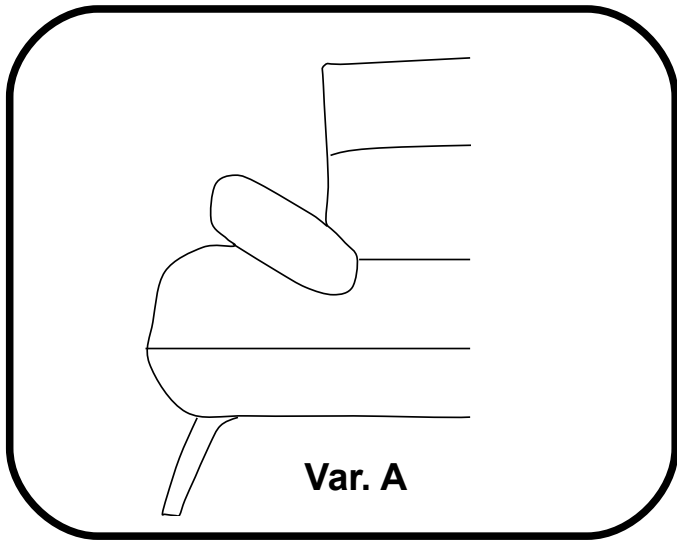

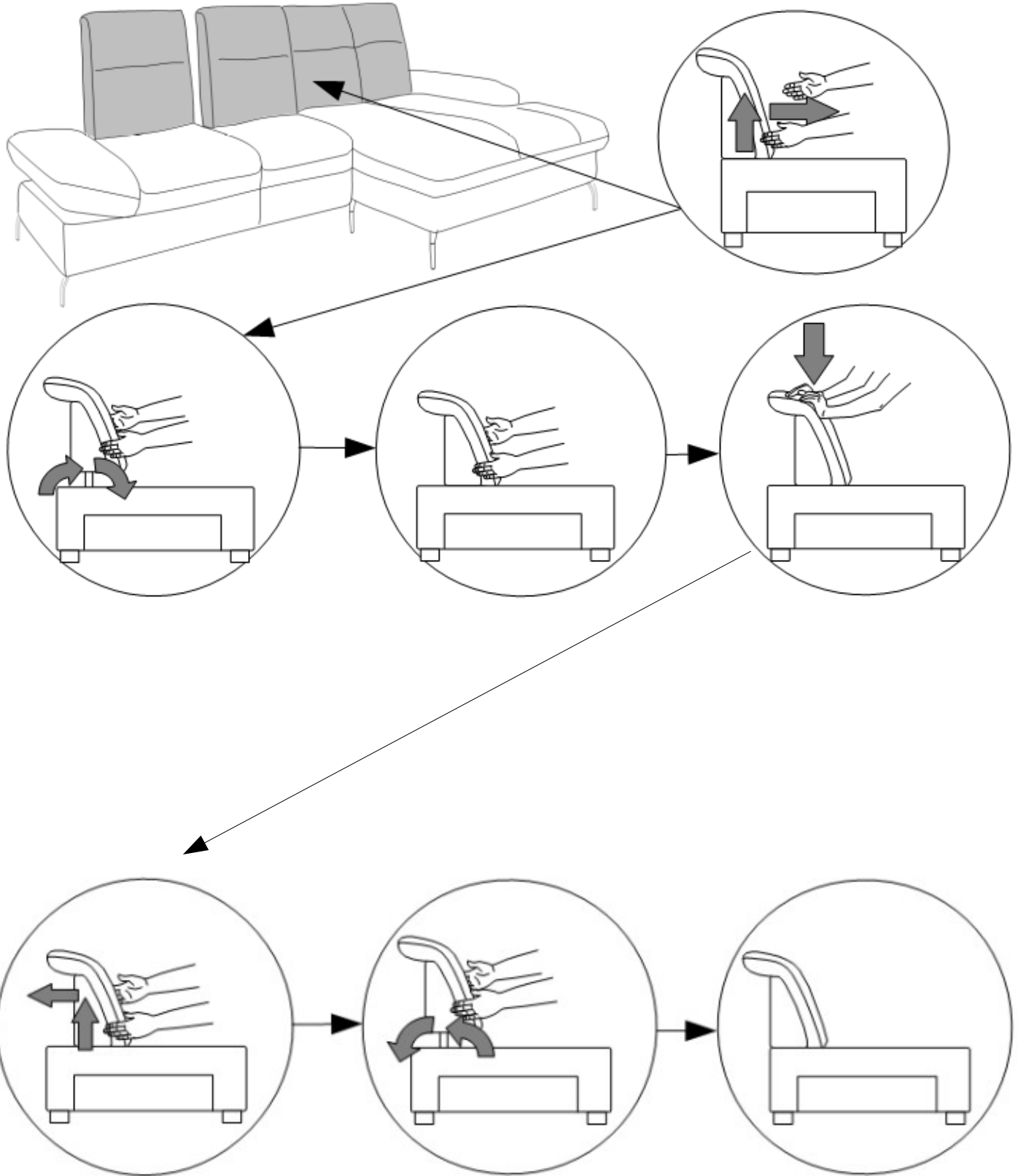
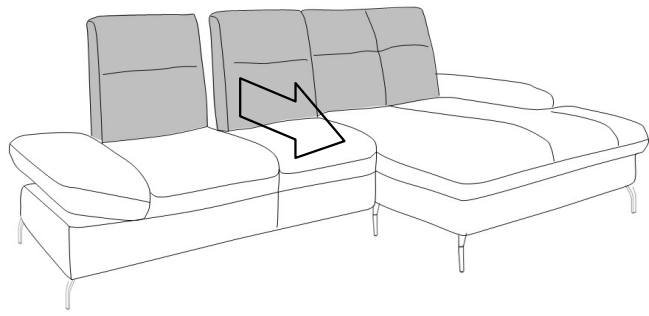

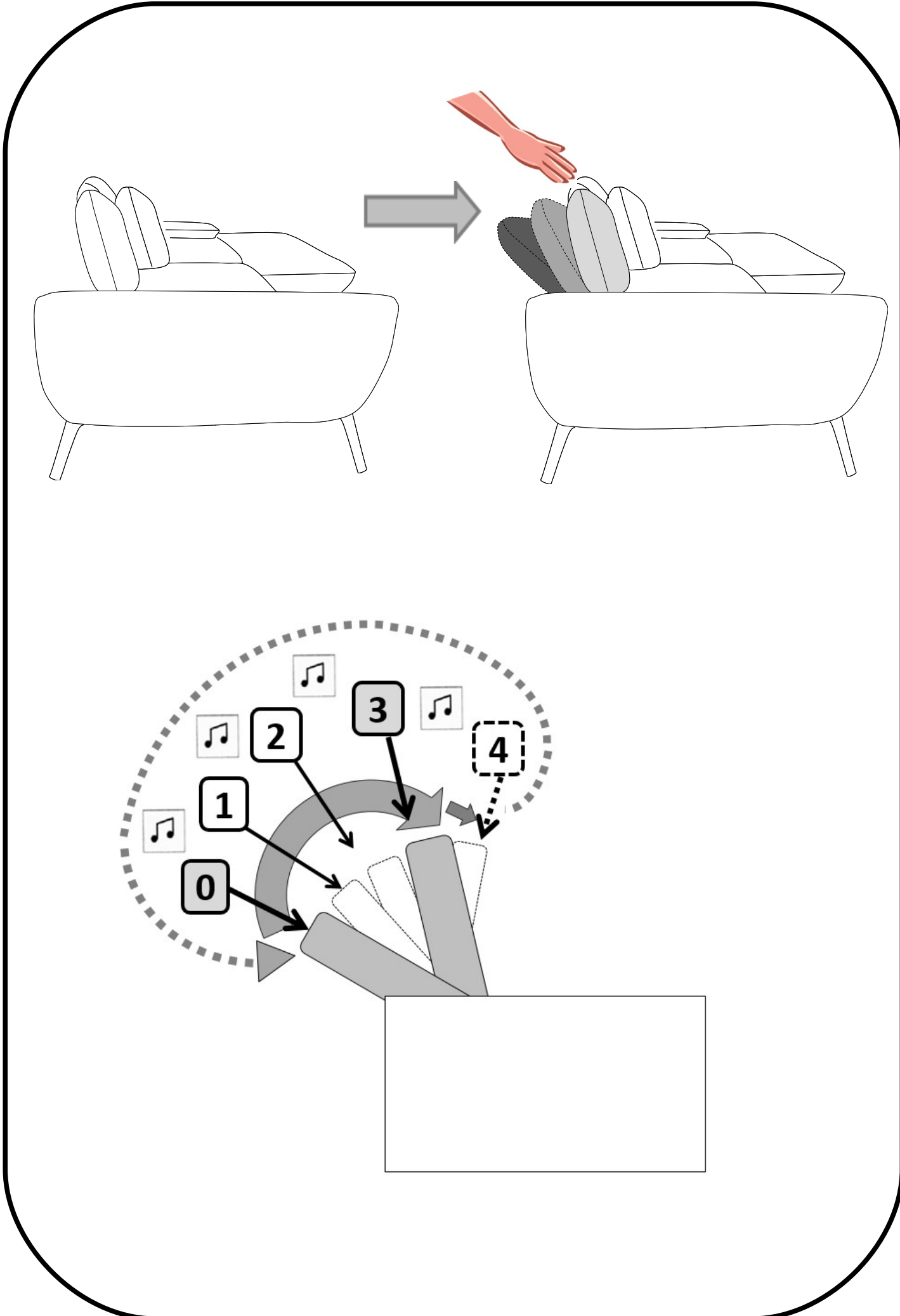

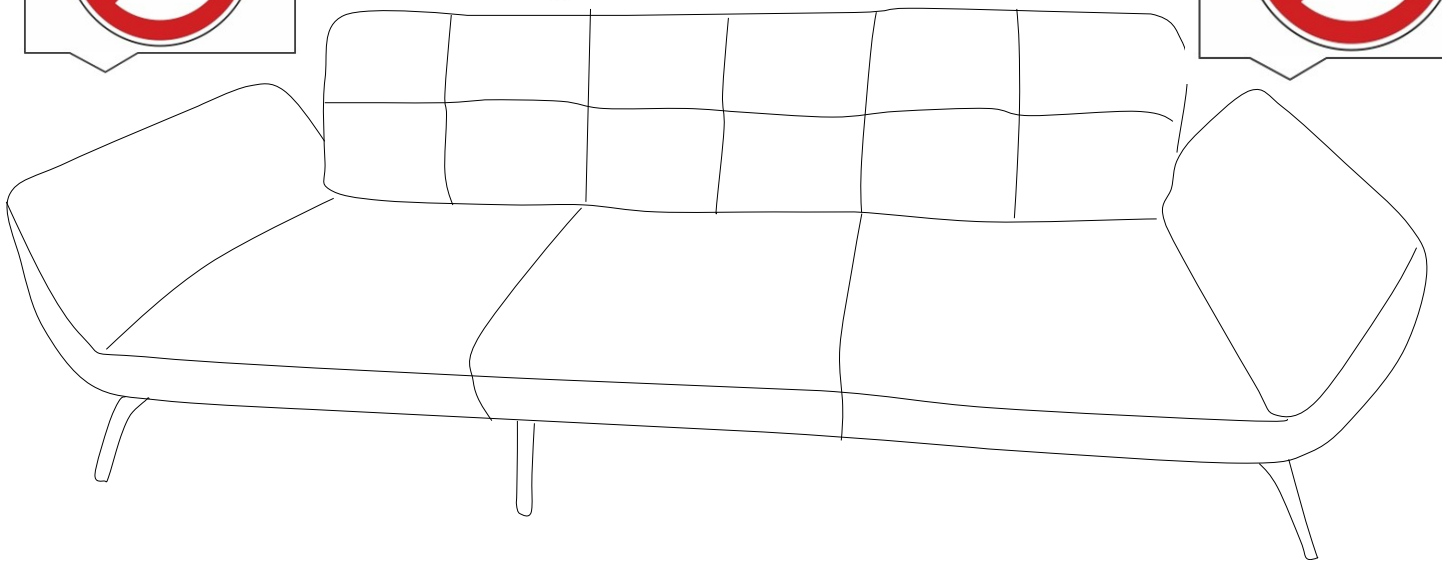

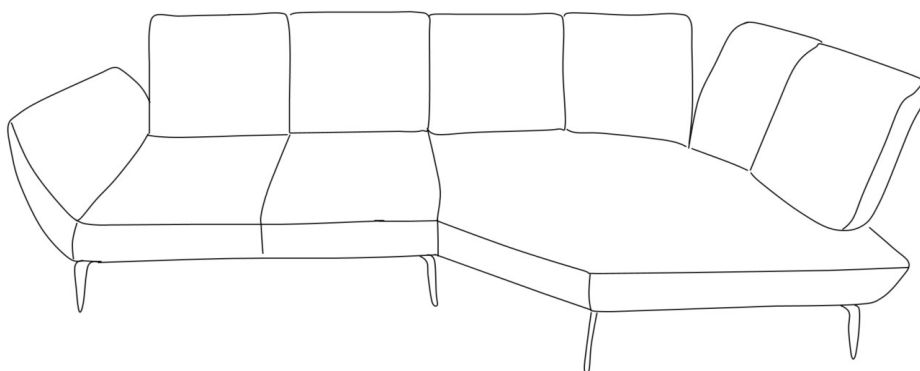
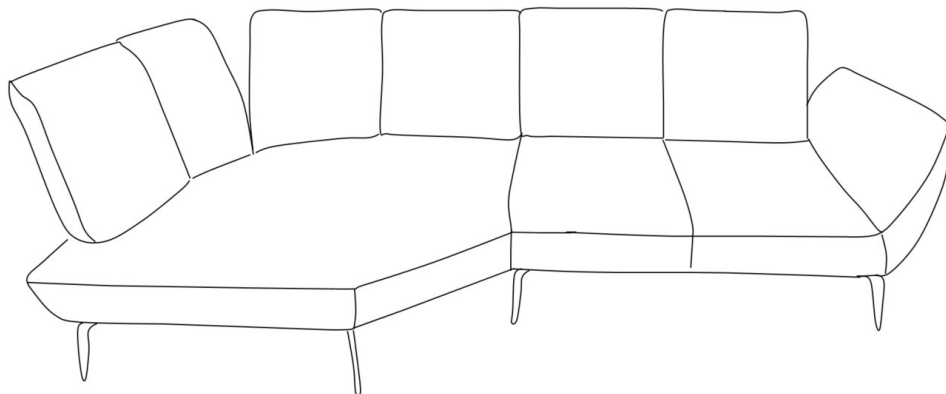
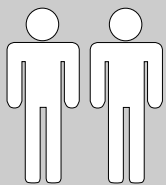

D MONTAGEANLEITUNG
BEDIENUNGSANLEITUNG

NL HANDLEIDING VOOR DE MONTAGE
GEBRUIKSAANWIJZING

TR MONTAJ TALIMATI
KULLANIM KLAVUZU

RO INSTRUCȚIUNI DE INSTALARE
INSTRUCȚIUNI DE UTILIZARE

FR NOTICE DE MONTAGE
MANUEL INSTRUCTIONS

HU KÖZGYŰLÉS UTASÍTÁSOK
KEZELÉSI UTASÍTÁS

SI NAVODILA ZA MONTAŽO
NAVODILA ZA UPORABO

ES INSTRUCCIONES DE MONTAJE
MANUAL DEL USUARIO

GB ASSEMBLY INSTRUCTIONS
INSTRUCTION MANUAL

PL INSTRUKCJA MONTAŻU
INSTRUKCJA OBSŁUGI

RU ИНСТРУКЦИЯ ПО МОНТАЖУ
ИНСТРУКЦИЯ ПО ЭКСПЛУАТАЦИИ

IT ISTRUZIONI DI MONTAGGIO
MANUALE DI ISTRUZIONI

SK MONTÁŽNY NÁVOD
NÁVOD NA POUŽITIE

CZ MONTÁŽNÍ NÁVOD
NÁVOD K POUŽITÍ

PT INSTRUÇÕES DE MONTAGEM
MANUAL DO USUÁRIO

HR UPUTE ZA MONTAŽU
UPUTE ZA UPOTREBU

Montageanleitung vom Eckelement mit dem Steckruecken

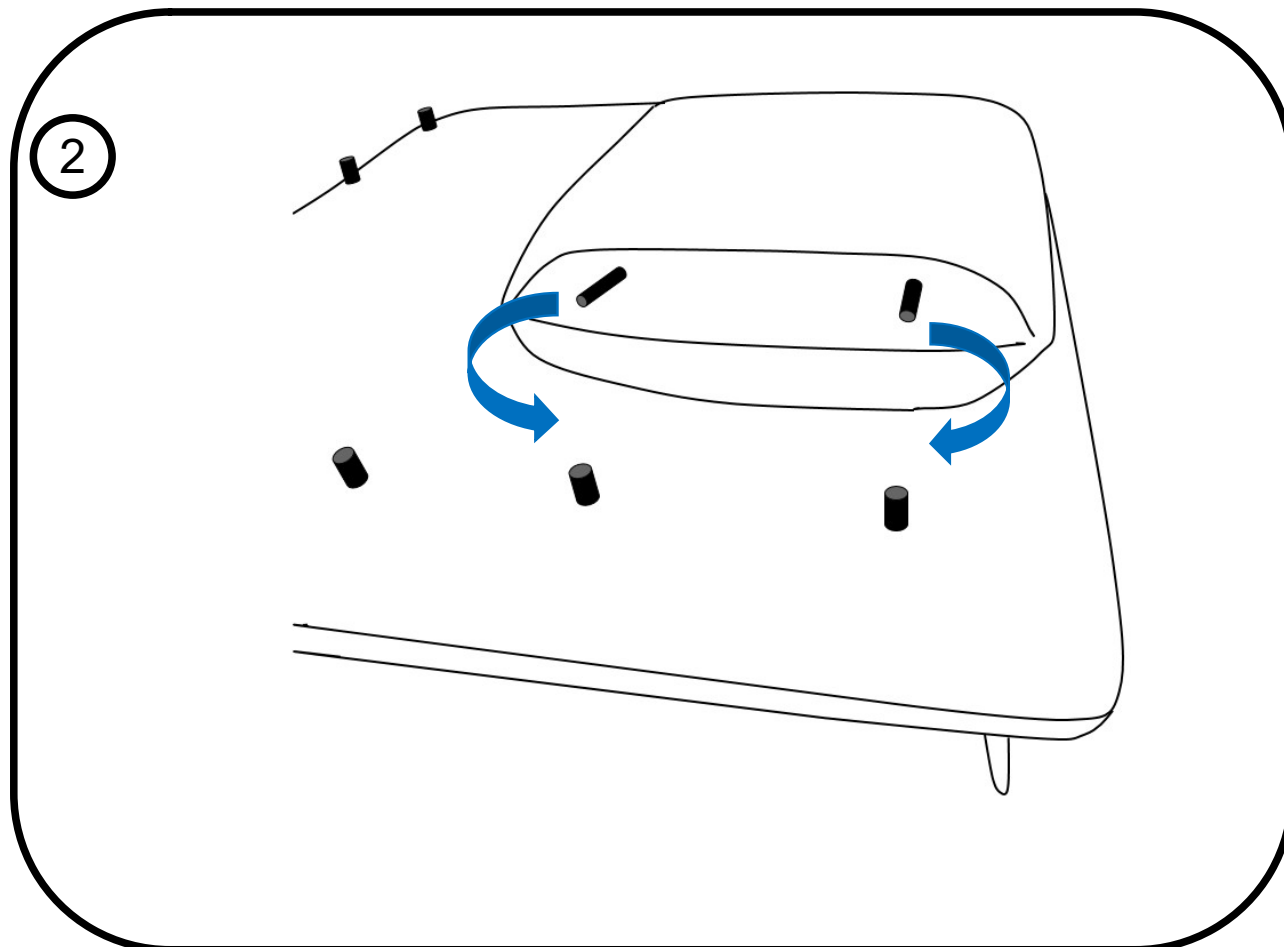
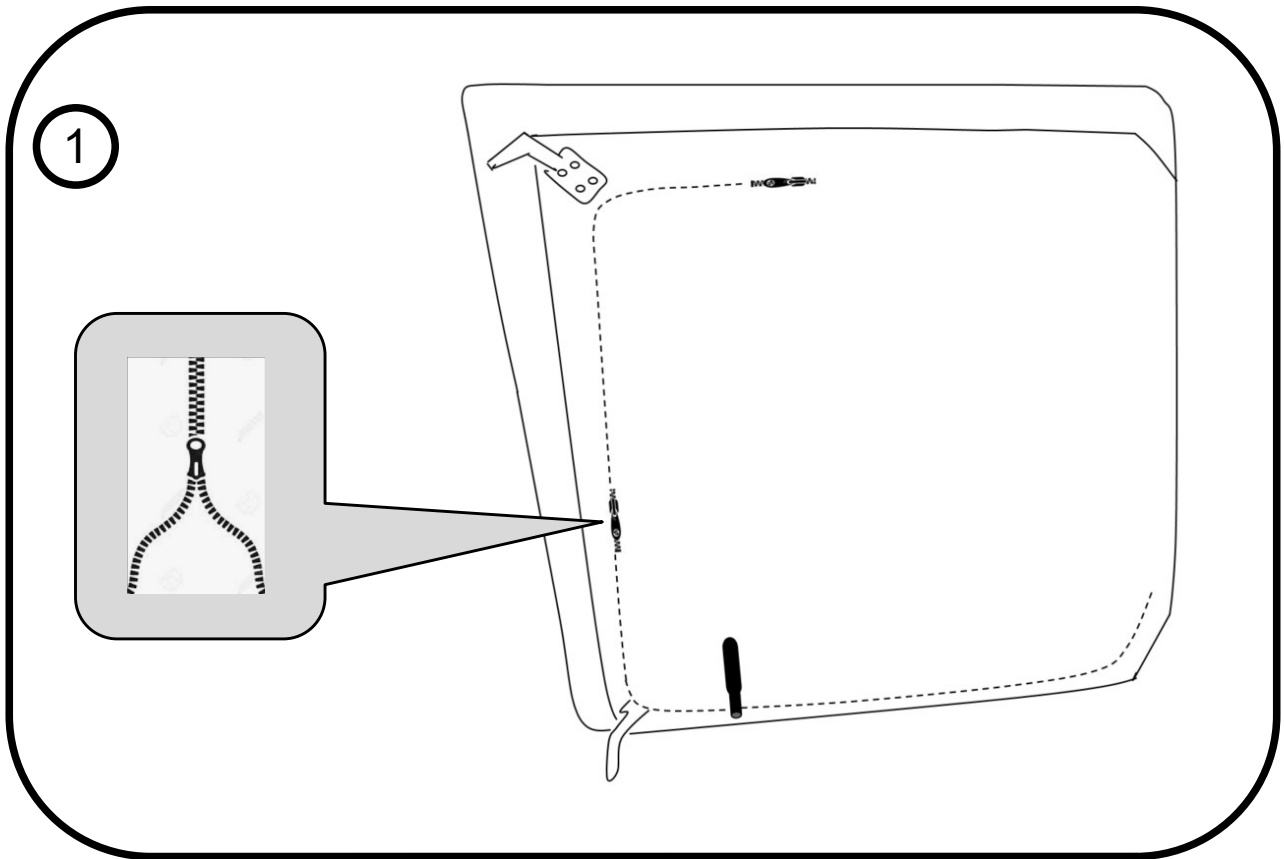

3

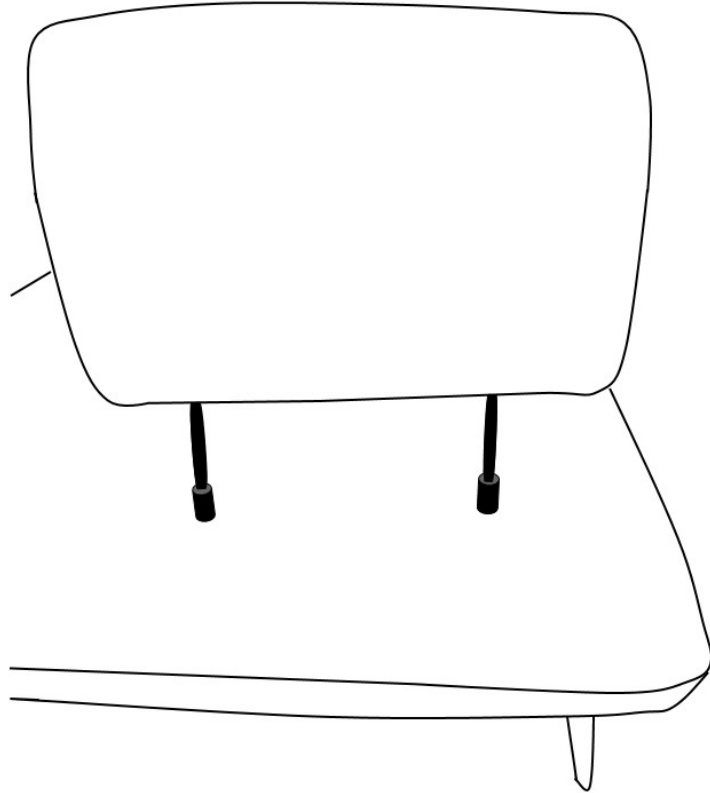

4

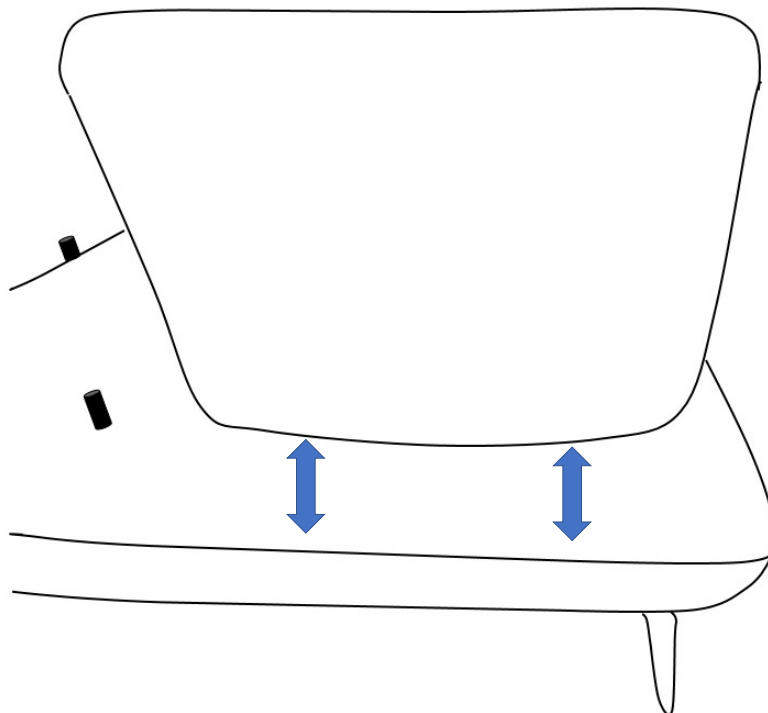

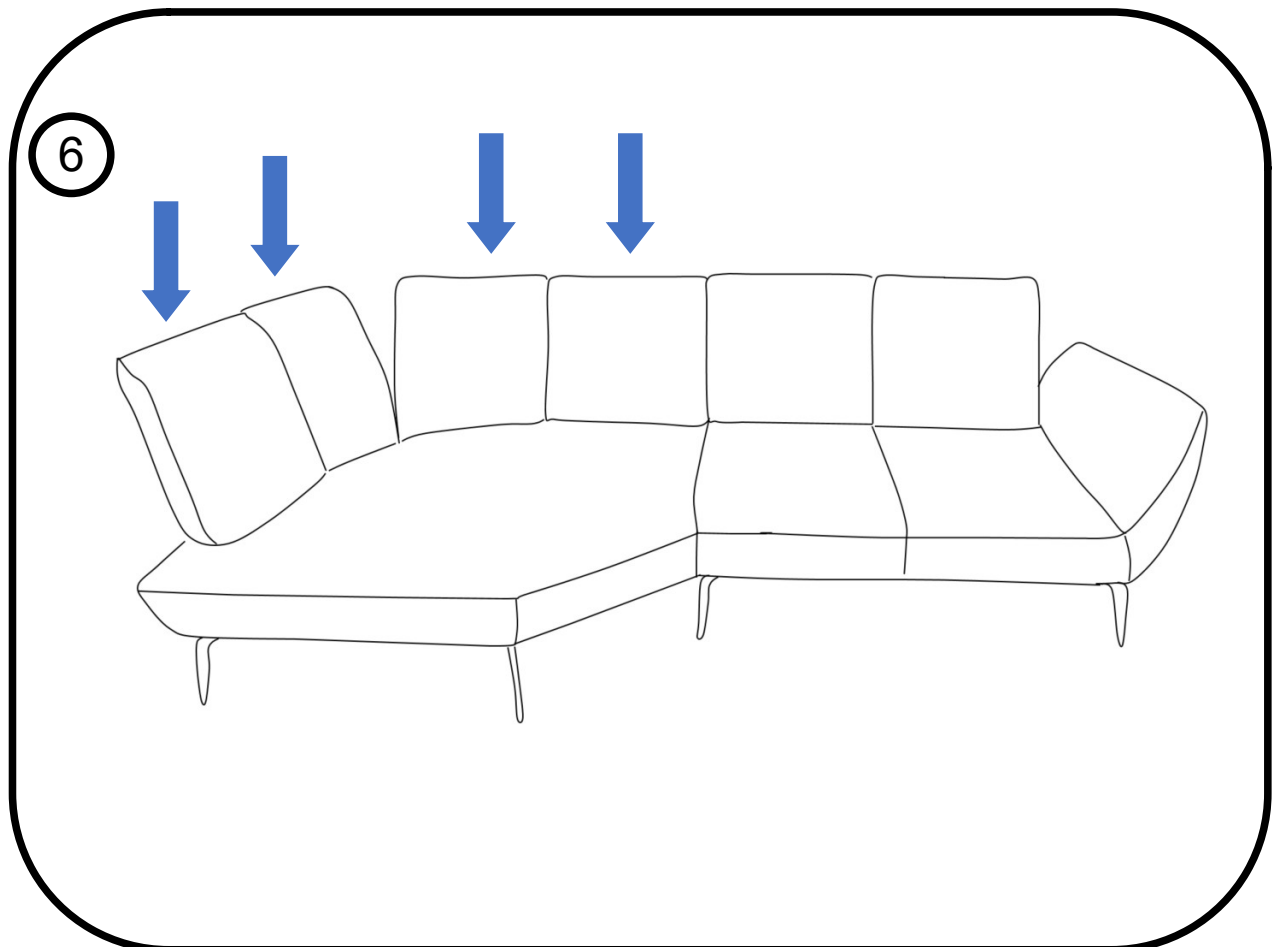
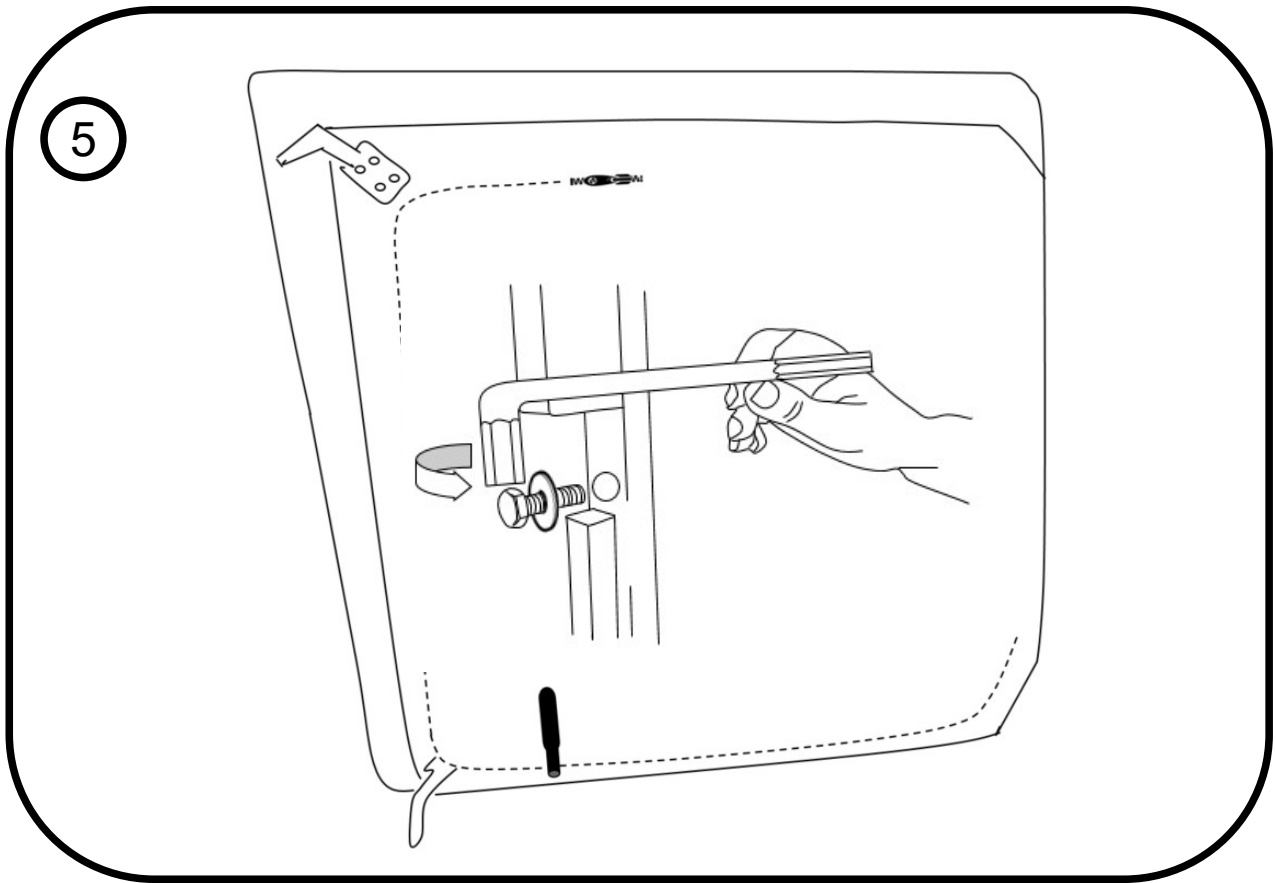

7

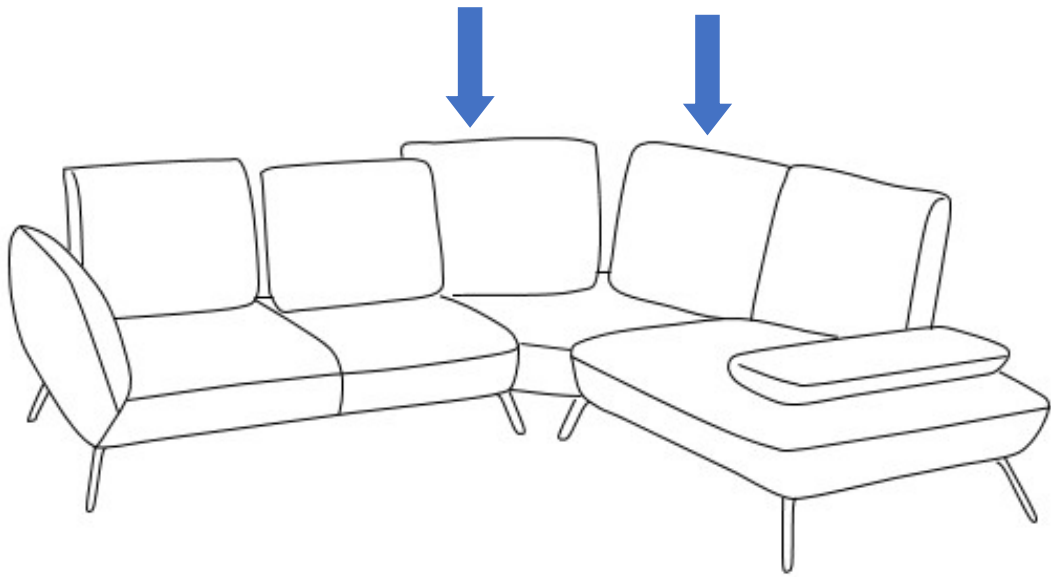

8

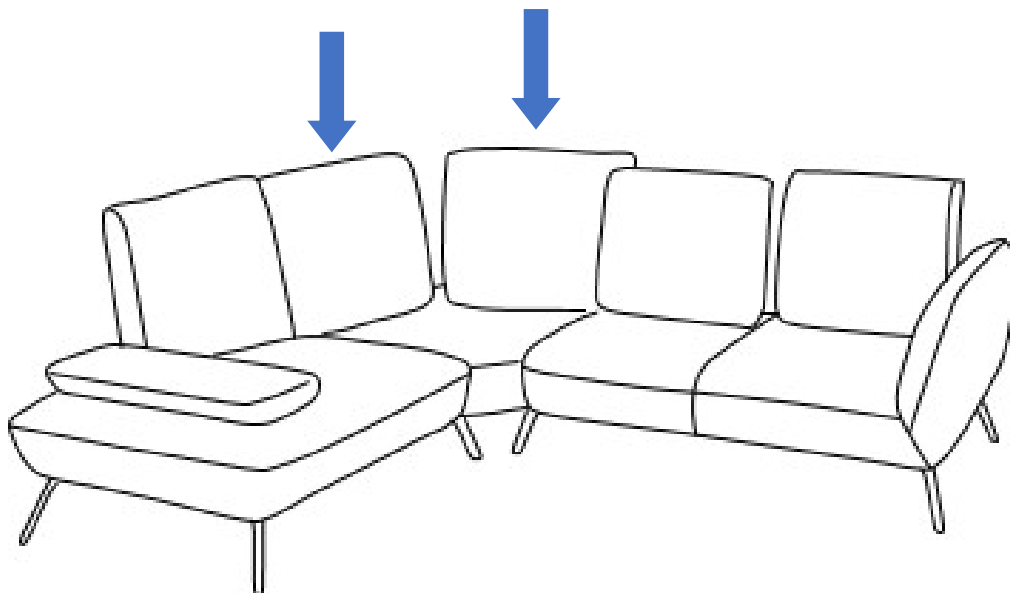

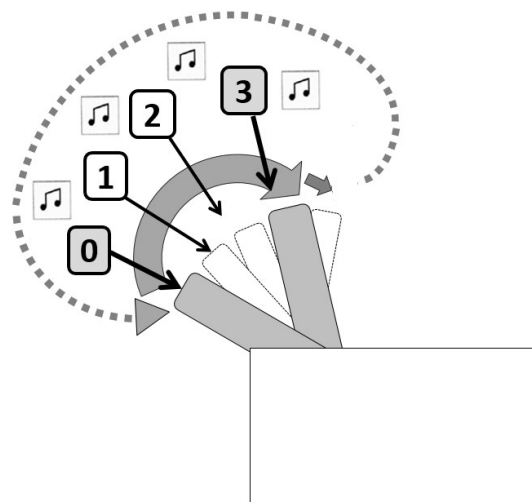
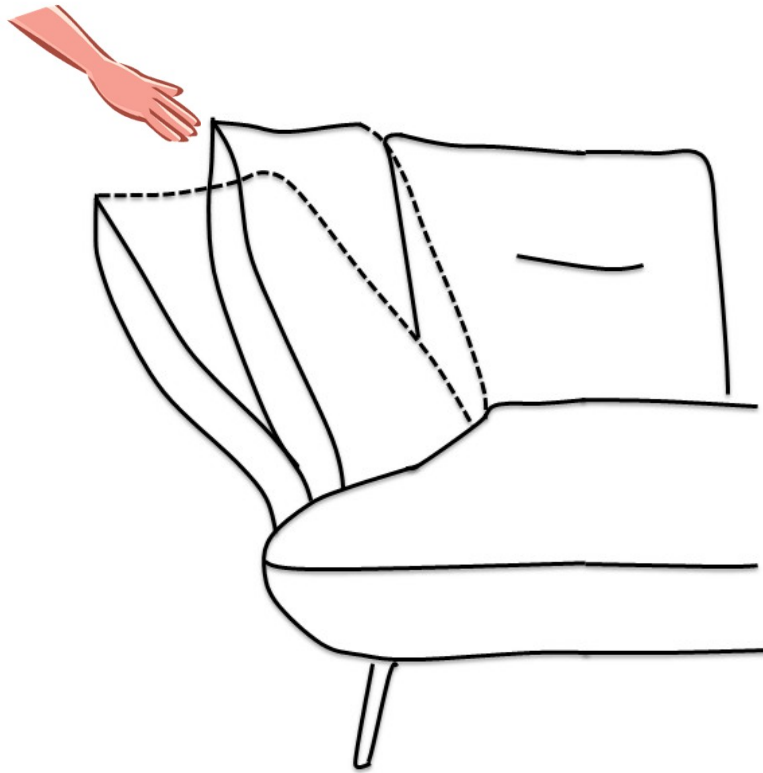
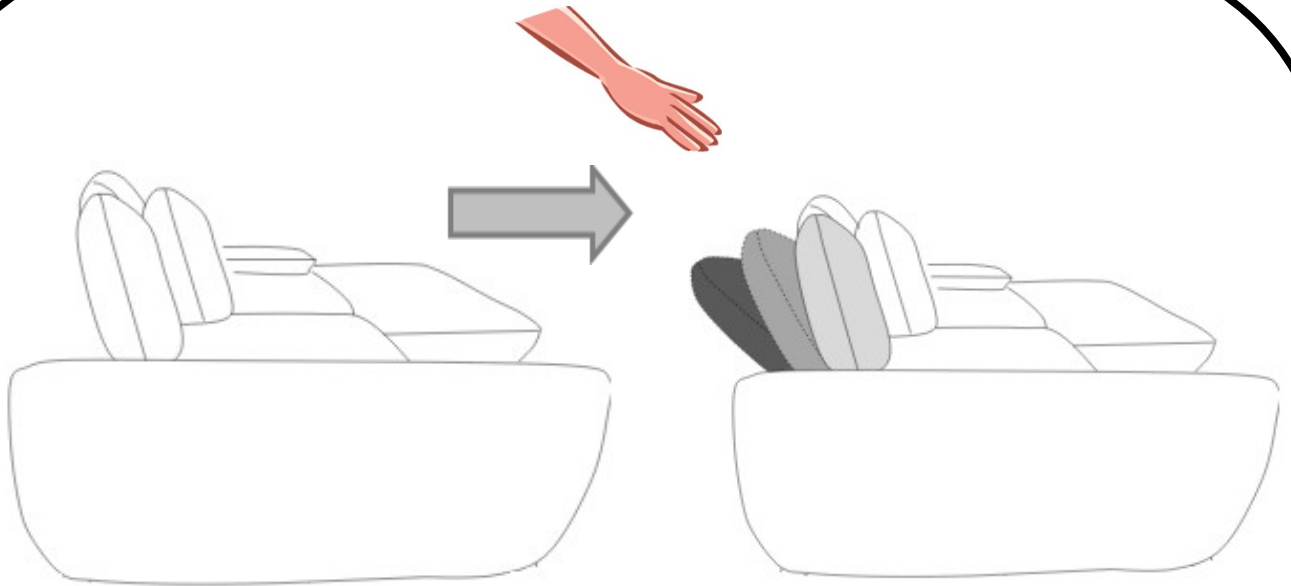

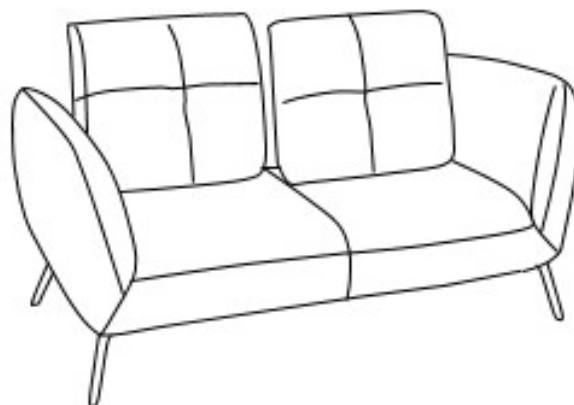
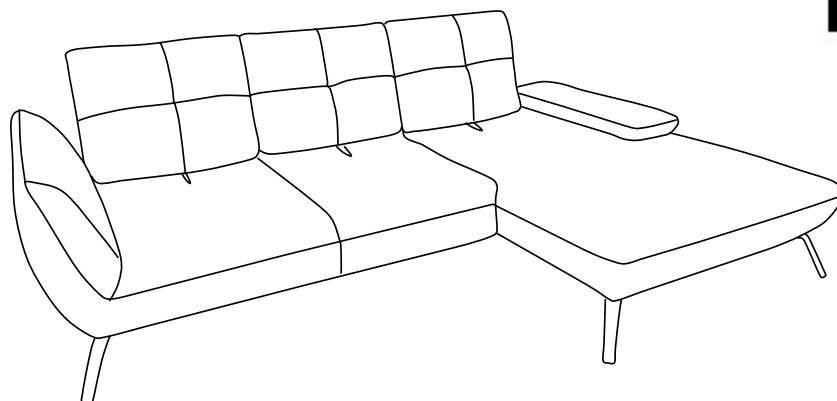
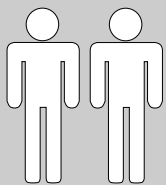

- | | | | |
|-----------|--|-----------|---|
| D | MONTAGEANLEITUNG
BEDIENUNGSANLEITUNG | GB | ASSEMBLY INSTRUCTIONS
INSTRUCTION MANUAL |
| NL | HANDLEIDING VOOR DE MONTAGE
GEBRUIKSAANWIJZING | PL | INSTRUKCJA MONTAŻU
INSTRUKCJA OBSŁUGI |
| TR | MONTAJ TALIMATI
KULLANIM KLAVUZU | RU | ИНСТРУКЦИЯ ПО МОНТАЖУ
ИНСТРУКЦИЯ ПО ЭКСПЛУАТАЦИИ |
| RO | INSTRUCȚIUNI DE INSTALARE
INSTRUCȚIUNI DE UTILIZARE | IT | ISTRUZIONI DI MONTAGGIO
MANUALE DI ISTRUZIONI |
| FR | NOTICE DE MONTAGE
MANUEL INSTRUCTIONS | SK | MONTÁŽNY NÁVOD
NÁVOD NA POUŽITIE |
| HU | KÖZGYŰLÉS UTASÍTÁSOK
KEZELÉSI UTASÍTÁS | CZ | MONTÁŽNÍ NÁVOD
NÁVOD K POUŽITÍ |
| SI | NAVODILA ZA MONTAŽO
NAVODILA ZA UPORABO | PT | INSTRUÇÕES DE MONTAGEM
MANUAL DO USUÁRIO |
| ES | INSTRUCCIONES DE MONTAJE
MANUAL DEL USUARIO | HR | UPUTE ZA MONTAŽU
UPUTE ZA UPOTREBU |

Montageanleitung der Ruecken mit dem Click&Seat Beschlag

1

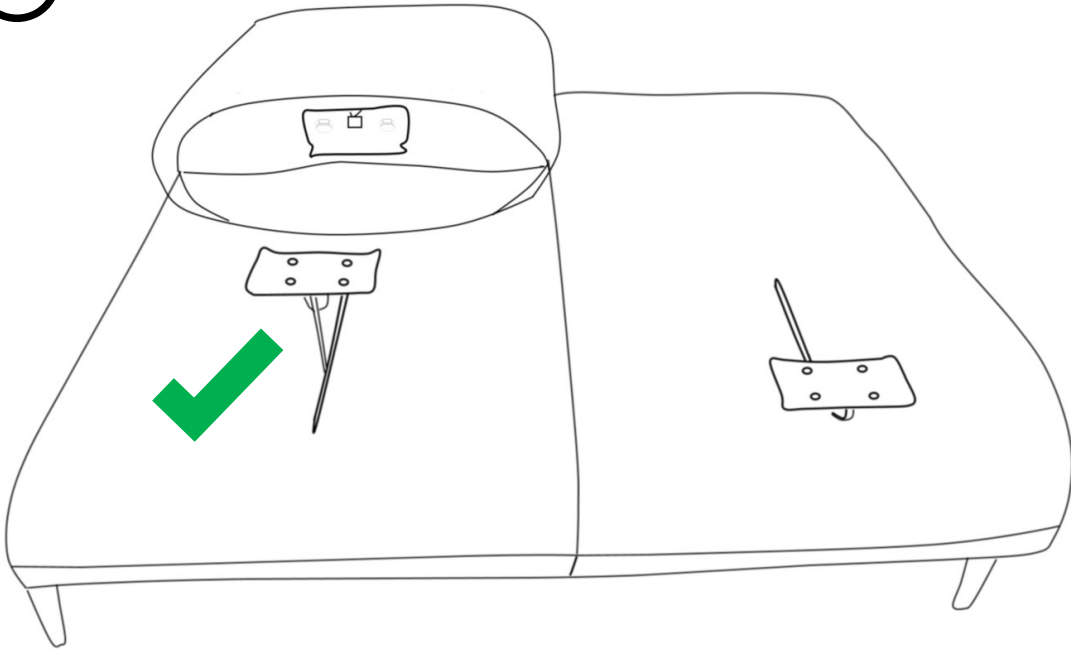

2

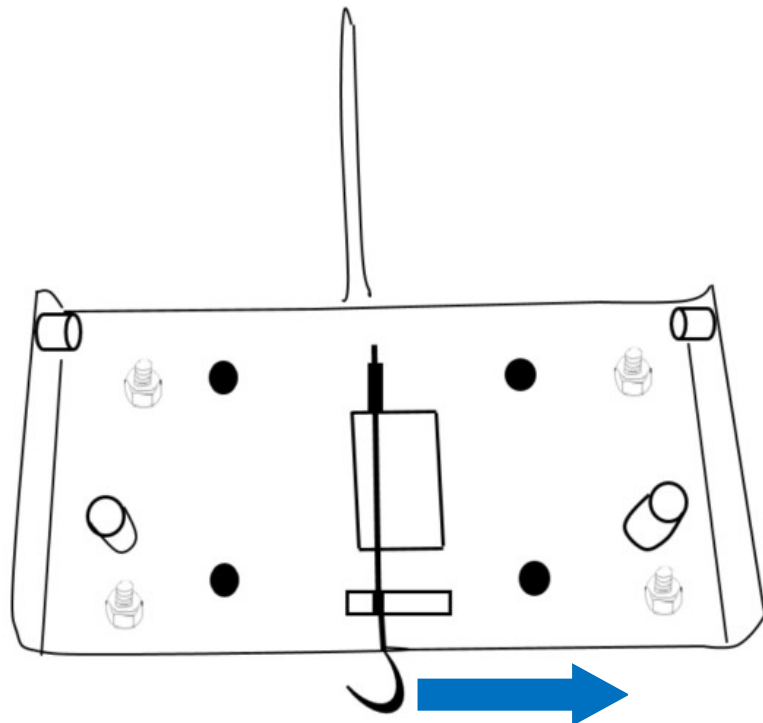

3

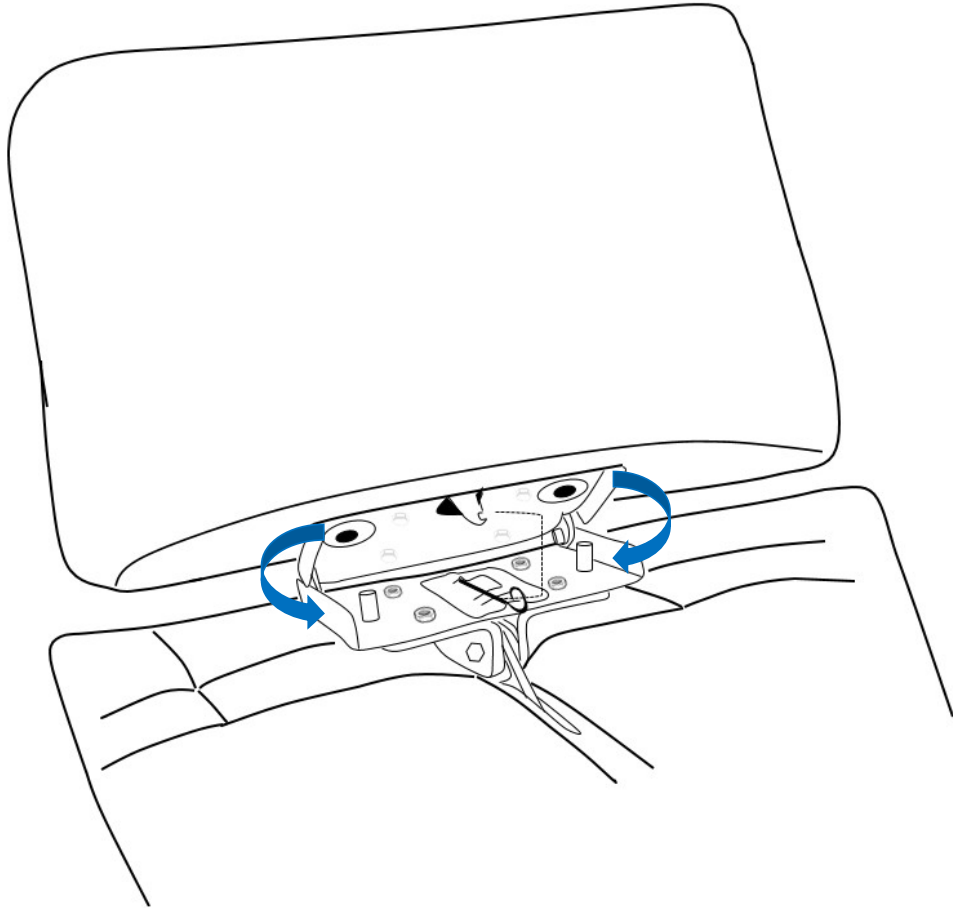

4

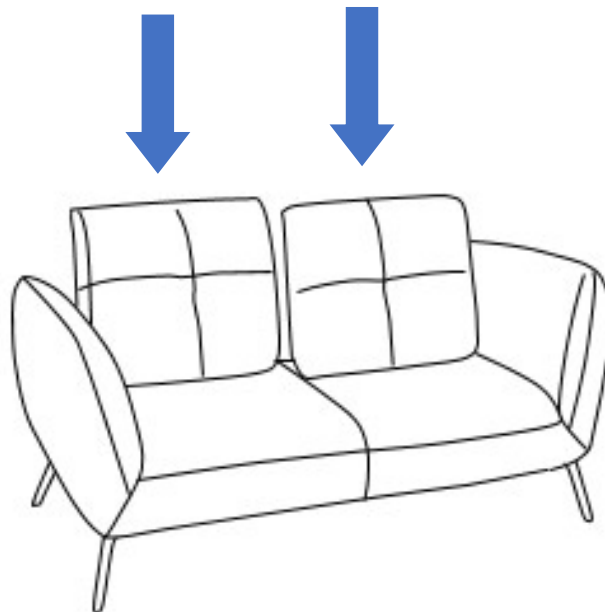

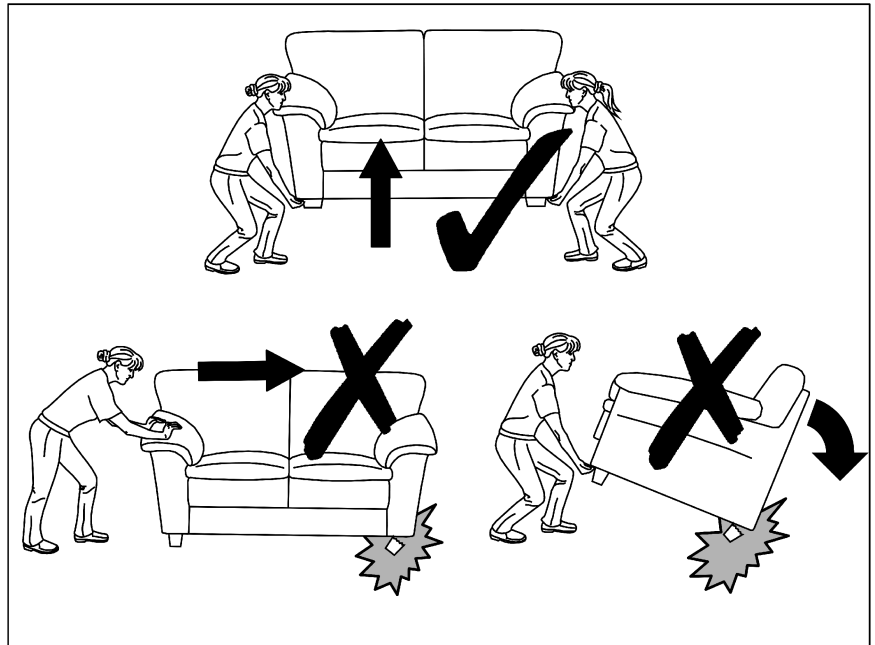
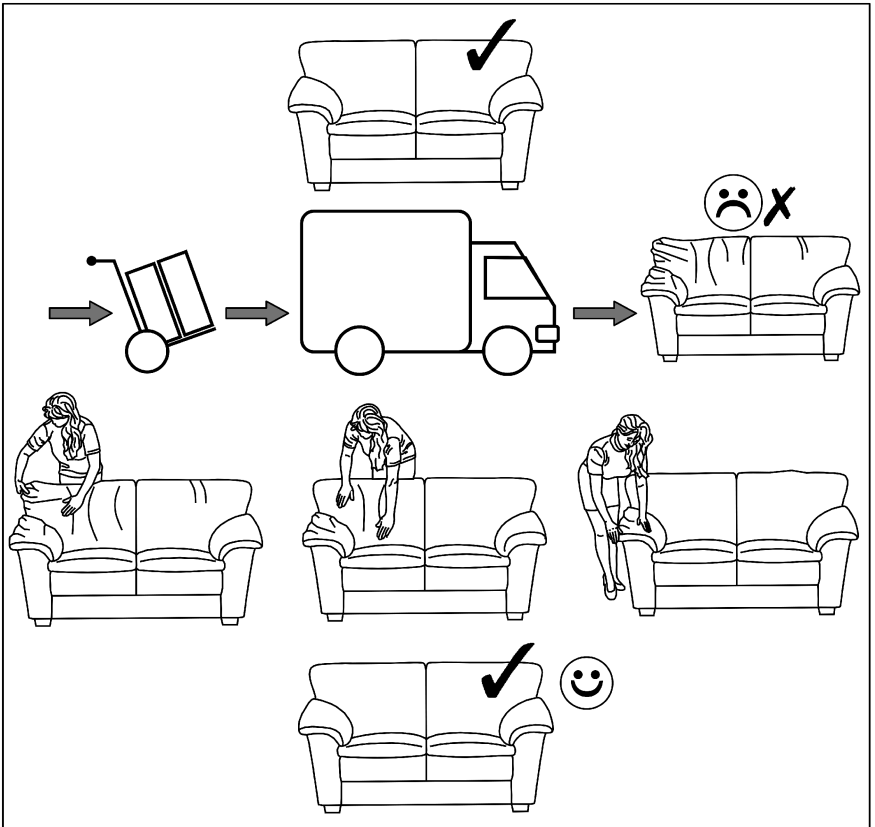
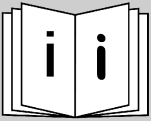

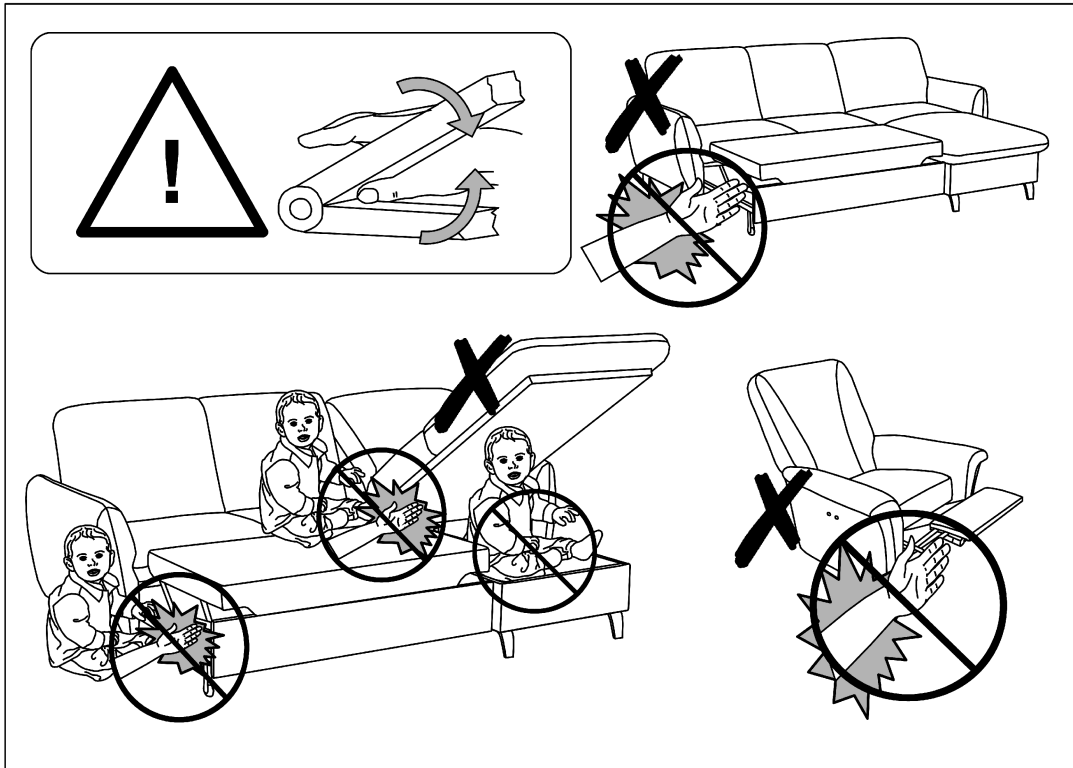
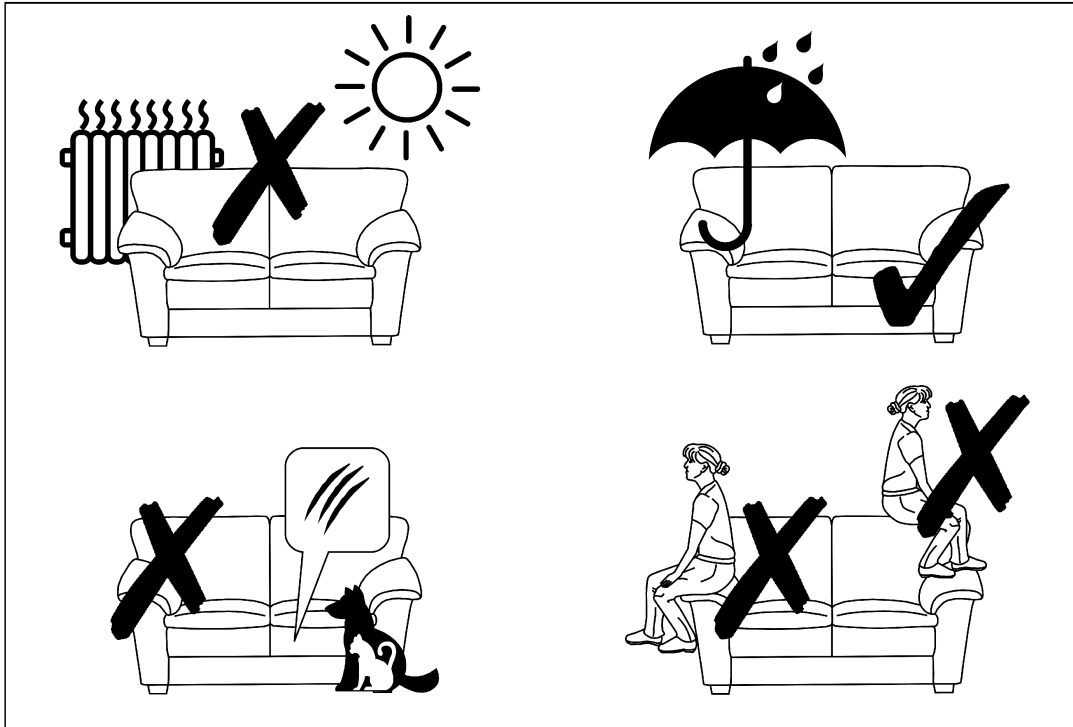

(DE) PFLEGEHINWEISE:

1. SORGFÄLTIG ENTSTAUBEN
2. MIT EINEM WEICHEN, SAUBEREN UND FEUCHTEM TUCH UND LEICHTER SEIFENLAUGE REINIGEN

	DEKOR PAPIER	OBERFLÄCHE LAMINAT	OBERFLÄCHE LACK	LACKIERTEN HOLZ	TEXTIL LEDER
SEIFENLAUGE (NEUTRAL SEIFE)	✓	✓	✓	✓	✓
WASSER MIT HAUSHALTREINIGER		✓	✓		
REINIGUNG NACH HERSTELLERVORGABE					✓

- BENUTZEN SIE KEINE SCHEUERMITTEL WIE PULVER, STAHLWOLLE, LÖSUNGSMITTEL
- NICHT ZU NASS ABWISCHEN

(GB) CONSERVATION ADVICES:

1. CAREFULLY WIPE OFF THE DUST
2. MOISTEN A SOFT, CLEAN CLOTH WITH SOAPY WATER

	VEENER WOOD	LAMINATE SURFACE	LAMINATED WOOD SURFACE	VARNISHED SURFACE	FABRIC LEATHER
WATER WITH SOAP (GREY SOAP)	✓	✓	✓	✓	✓
WATER WITH DETERGENT		✓	✓		
MAINTENANCE PRESCRIBED BY THE MANUFACTURER					✓

- DO NOT USE ABRASIVE PRODUCTS: POWDERS, STEEL WOOL, SOLVENTS
- DO NOT OVER-WET

(FR) CONSEILS D'ENTRETIEN:

1. DÉPOUSSIERER SOIGNEUSEMENT
2. HUMIDIFIER UN CHIFFON DOUX ET PROPRE D'EAU SAVONNEUSE

	BOIS DE PLACAGE	SURFACES STRATIFIÉES	SURFACES LAQUÉES	BOIS VERNIS	TISSU CUIR
EAU SAVONNEUSE (SAVON NEUTRE)	✓	✓	✓	✓	✓
EAU ADDITIONNÉE DE DÉTERGENT		✓	✓		
ENTRETIEN SPÉCIFIQUE FABRICANT					✓

- NE JAMAIS UTILISER DE PRODUITS ABRASIFS: POUDRE À RÉCURER, LAINE D'ACIER, SOLVANTS
- NE PAS TROP MOUILLER

(PL) PORADY W ZAKRESIE KONSERWACJI:

1. ZETRZEĆ DOKŁADNIE KURZ
2. CZYSTĄ I DELIKATNĄ ŚCIERECZKĘ ZWILŻYĆ LEKKO W WODZIE Z NIEWIELKĄ ILOŚCIĄ MYDŁA

	OKLEINA	POWIERZCHNIA LAMINATU	POW. DREWNA LAKOWANEGO	POWIERZCHNIA LAKIEROWANA	TKANINA SKÓRA
WODA Z MYDŁEM (SZARE MYDŁO)	✓	✓	✓	✓	✓
WODA Z DODATKIEM ŚRODKA MYJĄCEGO		✓	✓		
KONSERWACJA ŚCIŁIE WEDŁUG ZALECEŃ PRODUCENTA					✓

- NIGDY NIE UŻYWAĆ PRODUKTÓW ŚCIERNYCH: PROSZKÓW, DRAPAKÓW, ROZPUSZCZALNIKÓW
- NIE MOCZYĆ DUŻĄ ILOŚCIĄ WODY

(IT) CONSIGLI PER LA MANUTENZIONE:

1. SPOLVERATE ACCURATAMENLE
2. INUMIDIRE CON ACQUA LEGGERMENTE INSAPONATA UNO STRACCIO MORBIDO PULITO

	CARTA	SUPERFICIE STRATIFICATA	SUPERFICIE LACCATE	LACCATE E LEGNO VERNICIATO	TESSILE PELLE
ACQUA CON SAPONE (SAPONE NEUTRO)	✓	✓	✓	✓	✓
ACQUA CON DETERSIVO SAN MARO		✓	✓		
MANUTENZIONE SPECIFICA PRODUTTORE					✓

- NON UTILIZZARE MAI PRODOTTI ABRASIVI: POLVERE, LANA DI ACCIAIO, SOLVENTI
- NON BAGNARE TROPPO

(ES) CONSEJOS PARA EL MANTENIMIENTO:

1. LIMPIAR EL POLVO CON CUIDADO
2. HUMEDECER UN PAÑO SUAVE Y LIMPIO CON AGUA LIGERAMENTE ENJABONADA

	CHAPA DE MADERA	SUPERFICIE LAMINADA	MADERA BARNIZADA	SUPERFICIE LACADA	TELA PIEL
AGUA Y JABON (JABON NEUTRO)	✓	✓	✓	✓	✓
AGUA CON DETERGENTE		✓	✓		
MANTENIMIENTO ESPECIFICO DEL FABRICANTE					✓

- NO USE NUNCA PRODUCTOS ABRASIVOS TALES COMO POLVO DE LIMPIAR, RASCADOR, DISOLVENTES
- NO MOJAR EXAGERADAMENTE

(PT) CONSELHOS PARA A MANUTENÇÃO:

1. LIMPE O POEIRO COM CUIDADO
2. UMEDECER UM PAÑO SUAVE E LIMPO COM AGUA E UM POUCO DE SABAO

	PLACA DE MADEIRA	SUPERFÍCIE LAMINADA	MADEIRA ENVERNIZADA	SUPERFÍCIE LACADA	TELA PELE
AGUA COM SABÃO (SABÃO NEUTRO)	✓	✓	✓	✓	✓
AGUA COM ST MARC		✓	✓		
INSTRUÇÕES ESPECIFICAS					✓

- NUNCA UTILIZAR PRODUTOS ABRASIVOS POS, LA DE AÇO, SOLVENTES
- NAO MOLHAR DEMASIADO

(SK) TYPY NA ÚDRŽBU:

1. PRACH DOKŁADNE UTRITE
2. ČISTU A JEMNU HANDRIČKU NAVLHČIŤ LAHKO VO VODE Z MALÝM MNOŽSTVOM MYDLA

	TENKÁ LAMINÁTOVÁ	LAMINÁTOVÝ POVRCH	DREVENÝ POVRCH LAKOVANÝ	LAKOVANÝ POVRCH	TKANINA ČALÚDNEŇÁ
VODA Z MYDLOM	✓	✓	✓	✓	✓
VODA Z UMYVAJÚCIM PROSTRIEDKOM		✓	✓		
ÚDRŽBA IBA PODĽA POPISU VÝROBCU					✓

- NIKDY NEPOUŽÍVAŤ PROSTRIEDKY S DRSNÝM POVRCHOM : PRAŠKOV, DROBENIEK A RIEDIDIEL• NENAMÁČAJTE VEĽKÝM MNOŽSTVOM VODY

(CZ) TYPY NA UDRŽBU:

1. DŮKLADNĚ OTRIT PRACH
2. ČISTÝ A MĚKKÝ HADŘÍK LEHCE NAVLHČIT VE VODĚ S MALÝM MNOŽSTVÍM MÝDLA

	DÝHA	LAMINÁTOVÝ POVRCH	LAKOVANÝ DŘEVĚNÝ POVRCH	LAKOVANÝ POVRCH	KOŽENÁ ČALOUNĚNÁ LÁTKA
VODA S MÝDLEM	✓	✓	✓	✓	✓
VODA S ČISTIČÍM PROSTŘEDKEM		✓	✓		
DODRŽET ÚDRŽBU POSKYTOVANOU VÝROBCEM					✓
• NEPOUŽÍVEJTE ABRASIVNÍ PROSTŘEDKY: PRASEK, ROZPOUSTĚDLA					
• NENAMACĚJTE VELKÉ MNOŽSTVÍ VODY					

(NL) ONDERHOUDSVOORSCHRIFT:

1. ZORGVULDIG STOFVRIJ MAKEN
2. MET EEN ZACHTE SCHONE EN VOCHTIGE DOEK MET NEUTRALE ZEEP REINIGEN

	FOLIE	TOPLAAG LAMINAAT	TOPLAAG LAK	GELAKT HOUT	TEXTIEL LEER
NEUTRALE ZEEP	✓	✓	✓	✓	✓
WATER MET HUISHOUD REINIGINGSMIDDEL		✓	✓		
DOOR DE PRODUCENT GESPECIFICEERD ONDERHOUD					✓
• GEBRUIKT U GEËN SCHUURMIDDELEN ZOALS SCHUURPOEDER, STAALWOL, OPLOSMIDDEL					
• NIET TE NAT AFNEMEN					

(HU) KARBANTARTÁSI TANÁCSOK:

1. ALAPOSAN LETÖRÖLNI A PORT
2. EGY TISZTA ÉS LÁGY TÖRLŐKENDŐT BENEDVESÍTENI ENYHÉN SZAPPANOS VÍZZEL

	FURNÉR	LAMINÁLT FELÜLET	LAKKOZOTT FAFELÜLET	LAKKOZOTT FELÜLET	BŐRKÁRPIT
SZAPPANOS VÍZ (MOSÓSZAPPAN)	✓	✓	✓	✓	✓
MOSÓSZERES VÍZ		✓	✓		
KARBANTARTÁS SZIGORÚAN A GYÁRTÓ UTASÍTÁSAI SZERINT					✓
• SOHA NE HASZNÁLJON SÚROLO HATASU TISZTÍTÓSZERT: PORT, KAPAROT, OLDOSZERT					
• NE ZATASSA BO VÍZZEL					

(RO) SFATURI PENTRU ÎNTREȚINERE:

1. ȘTERGEȚI BINE PRAFUL
2. UMEZIȚI UȘOR O LAVETĂ USCATĂ ȘI DELICATĂ ÎN APĂ CU PUȚIN SĂPUN

	FURNIR	SUPRAFAȚĂ LAMINAT	SUPRAFAȚĂ LEMN LĂCUIT	SUPRAFAȚĂ LĂCUITĂ	ȚESĂTURĂ CĂPTUȘEALĂ PIELE
APĂ CU SĂPUN	✓	✓	✓	✓	✓
APĂ CU DETERGENT		✓	✓		
ÎNȚEȚINEȚI ÎN CONFORMITATE STRICTĂ CU RECOMANDĂRILE PRODUCĂTORULUI					✓
• NU FOLOSIȚI NICIODATĂ PRODUSE ABRASIVE: DETERGENȚI PRF, ZGĂRIETOARE, DILUANȚI					
• NU SPĂLAȚI CU O CANTITATE MARE DE APĂ					

(RU) РЕКОМЕНДАЦИИ ПО УХОДУ:

1. ТЩАТЕЛЬНО ВЫТЕРЕТЬ ПЫЛЬ
2. ЧИСТУЮ И МЯГКУЮ ТРЯПОЧКУ СЛЕГКА УВЛАЖНИТЬ В ВОДЕ С НЕБОЛЬШИМ КОЛИЧЕСТВОМ МЫЛА

	ОБЛИЦОВКА	ЛАМИНИРУЮЩА Я ПЛЁНКА	ПОВЕРХНОСТЬ ЛАКИРОВАННОЙ ДРЕВЕСИНЫ	ЛАКИРОВАННАЯ ПОВЕРХНОСТЬ	ОБИЧОВНАЯ ТКАНЬ, КОЖА
ВОДА С МЫЛОМ (ХОЗЯЙСТВЕННОЕ МЫЛО)	✓	✓	✓	✓	✓
ВОДА С ДОБАВКОЙ МОУЩЕГО СРЕДСТВА		✓	✓		
УХОД СТРОГО ПО УКАЗАНИЯМ ПРОИЗВОДИТЕЛЯ					✓
• НИВ КОЕМ СЛУЧАЕ НЕ ИСПОЛЬЗОВАТЬ АБРАЗИВНЫХ ИЗДЕЛИИ: ПОРОШКОВ, ЦАРАПОК, РАСТВОРИТЕЛЕЙ					
• НЕ СМАЧИВАТЬ БОЛЬШИМ КОЛИЧЕСТВОМ ВОДЫ					

(TU) BAKIM TALÍMATLARI:

1. TOZUNU DIKKATLICE ALINIZ
2. YUMUŞAK VE TEMİZ BİR BEZİ SABUNLU SU İLE ISLATINIZ

	KAPLAMA	LAMİNAT YÜZEY	LAKE AHŞAP YÜZEY	LAKE YÜZEY	DÖŞEMELİK KUMAŞ, DERİ
SABUNLU SU (NORMAL SABUN)	✓	✓	✓	✓	✓
DETERJANLI SU		✓	✓		
ÜRETİCİNİN BAKIM VE YIKAMA TALÍMATLARI					✓
• TOZ, TEL, SOLVENT GIBI AŞINDIRICI URUNLERİ KULLANMAYINIZ					
• BOL SU İLE ISLATMAYINIZ					

(SI) NASVETI ZA VZDRŽEVANJE:

1. SKRBNO OBRISITE PRAH
2. ČISTO IN MEHKO KRPO RAHLO NAVLAŽITE V VODI Z MAJHNO KOLIČINO MILA

	FURNIR	POVRŠINA LAMINATA	POVRŠINA LES LAK	LAKIRANA POVRŠINA	OBLAZINJENJE USNJE
VODA IN MILO (MEHKO MILO)	✓	✓	✓	✓	✓
VODA Z DODATKOM DETERGENTA		✓	✓		
VZDRŽEVATI DOSLEDNO V SKLADU Z NAVODILI PROIZVAJALCA					✓
• NIKOLI NE UPORABUJATE ABRASIVNIH SREDSTEV: PRAŠKOV, GOBIC IZ ŽICE, TOPIL					
• NE NAMAKAJTE Z VELIKO KOLIČINO VODE					

(HR) UPUTE ZA ODRŽAVANJE:

1. PAŽLJIVO OBRISATI PRAŠINU
2. PREBRISATI ČISTOM, MEKOM TKANINOM NAVLAŽENOJ U BLAGOJ OTOPINI SAPUNA ILI DETERDŽENTA

	PAPIR	LAMINAT	LAK	DRVO	TEKSTIL KOŽA
OTPINA SAPUNA	✓	✓	✓	✓	✓
OTPINA DETERDŽENTA		✓	✓		
NAMIJENSKA SREDSTVA					✓
• ZABRANJENA JE UPOTREBA KEMIKAJIJA ILI BILO KAKVIH POMOĆNIH SREDSTAVA ZA RIBANJE JAKIH DSREDSTAVA ZA ČIŠĆENJE ILI ČELIČNE VUNE					
• ZABRANJENO JE ČIŠĆENJE SA PREVIŠE VODE/VLAGE					

Herstellerkenzeichnung:

Hergestellt für VITO durch

SCS Sp. z o.o.

Ul. Fabryczna 13

69-110 Rzepin

Polen

poco@steinpol.com.pl