

ARNES

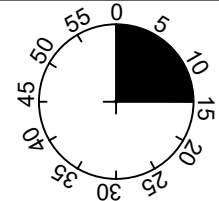

1

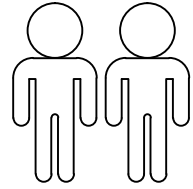
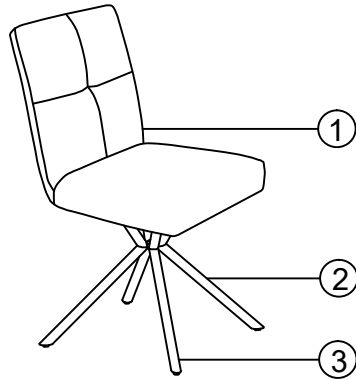
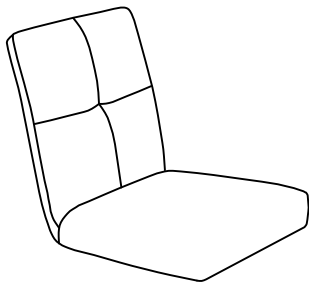

2

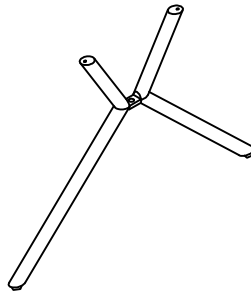

3

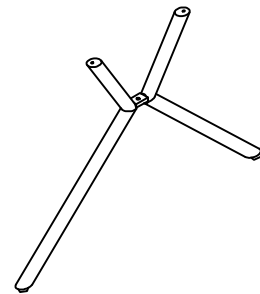

4

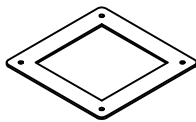

FAP 185x185mm AR

5

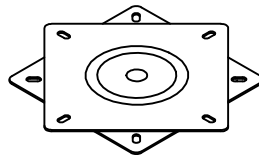

DT 180° AR 195X195mm

1	1x
2	1x
3	1x
4	1x
5	1x

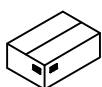

1/1

A

M6X20



9x

B

Ø18xØ6x1.5



9x

C

4MM

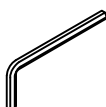



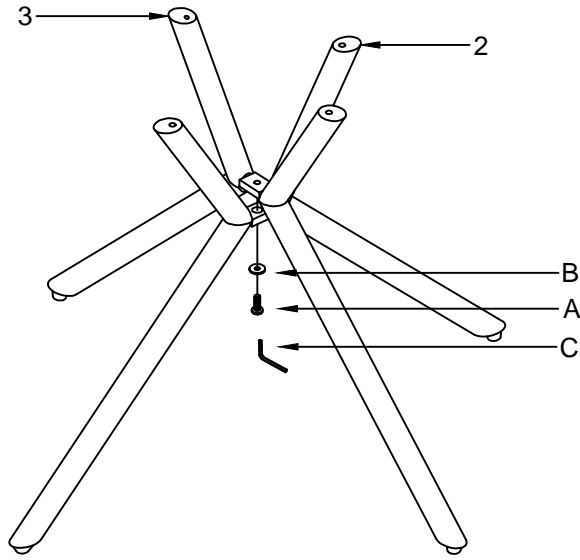

1x

I.



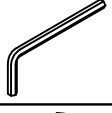

1

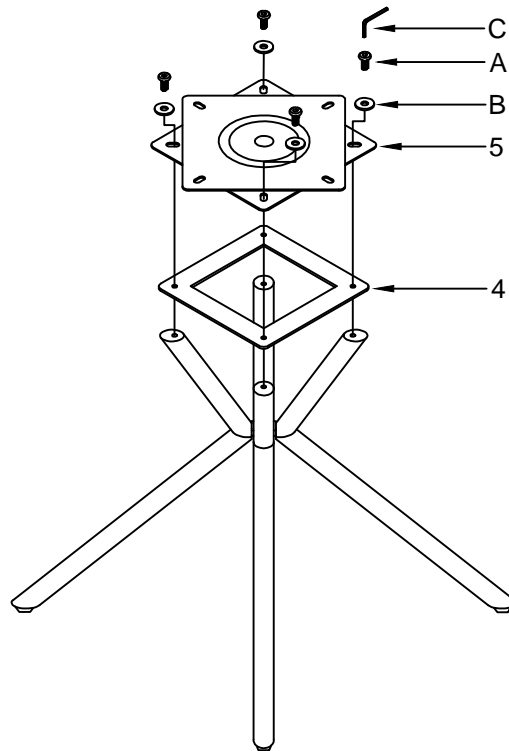

A	M6x20		1x
B	Ø18xØ6x1.5		1x
C	4MM		1x
			

2

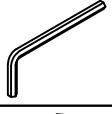



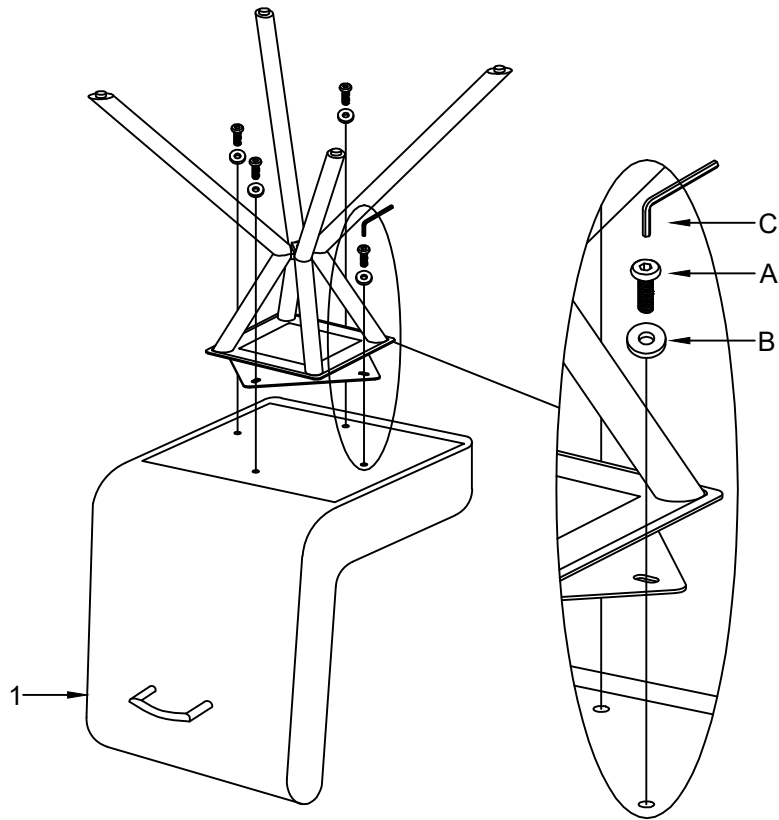

A	M6x20		4x
B	Ø18xØ6x1.5		4x
C	4MM		1x
			

II.

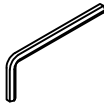

3

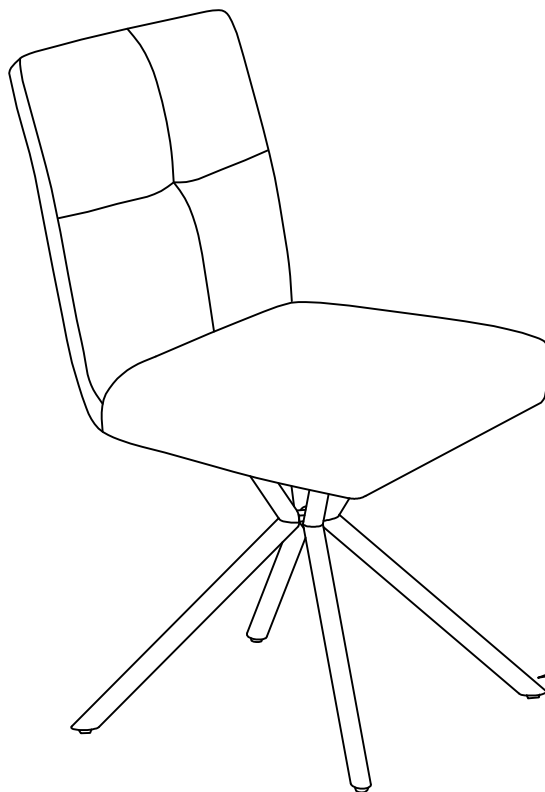

A	M6x20
	4x
B	Ø18xØ6x1.5
	4x
C	4MM
	1x
	

4

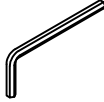

C	4MM
	1x
	



LE TRI
+ FACILE



Séparez les éléments avant de trier