

## BAREA

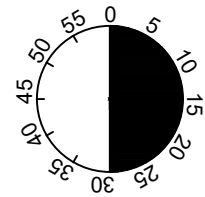

1

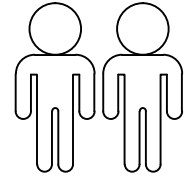
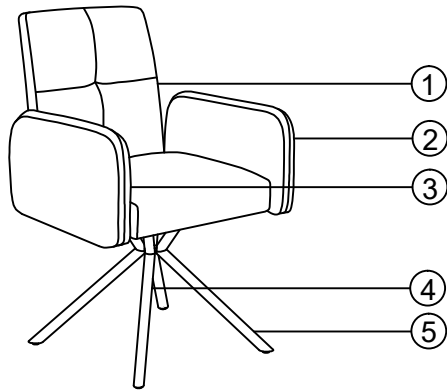
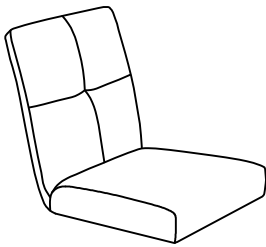

2

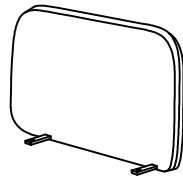

R

3

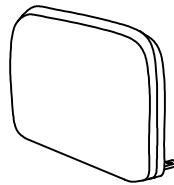

L

4

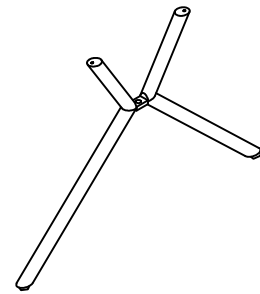

5

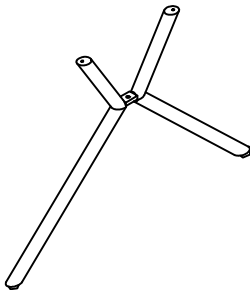

6

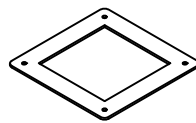

FAP 185x185mm AR

7

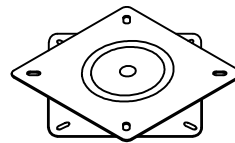

DT 180° AR 195X195mm

1	1x
2	1x
3	1x
4	1x
5	1x
6	1x
7	1x

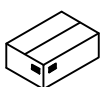

1/1

A

M6X20



9x

B

M6X30

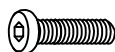

4x

C

M6



4x

D

Ø18xØ6x1.5



13x

E

4MM

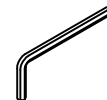



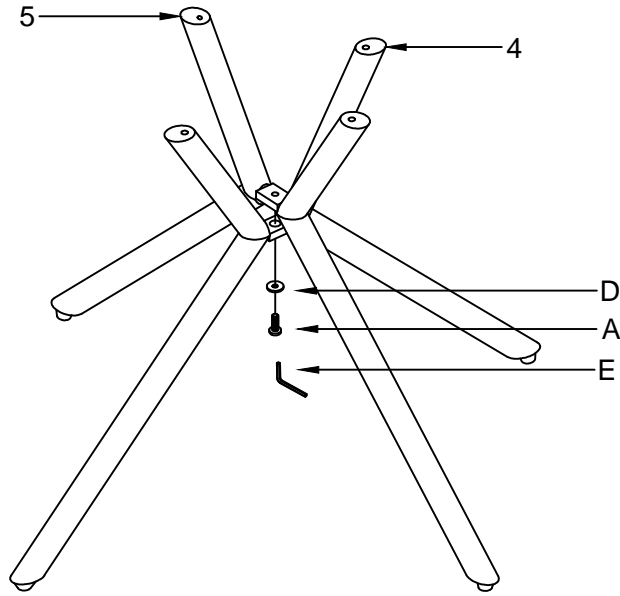

1x

I.

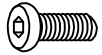

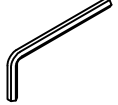

1

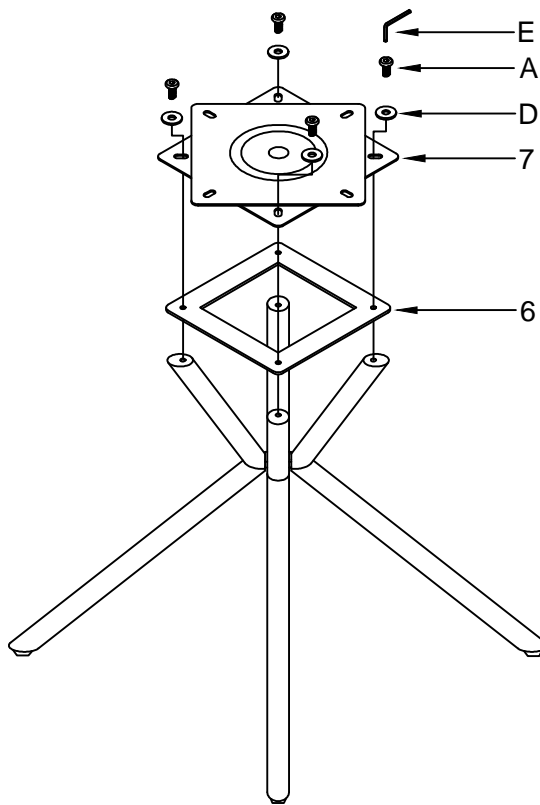

A	M6x20
	1x
D	Ø18xØ6x1.5
	1x
E	4MM
	1x
	

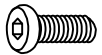
2

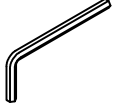

A	M6x20
	4x
D	Ø18xØ6x1.5
	4x
E	4MM
	1x
	

# II.

## 3

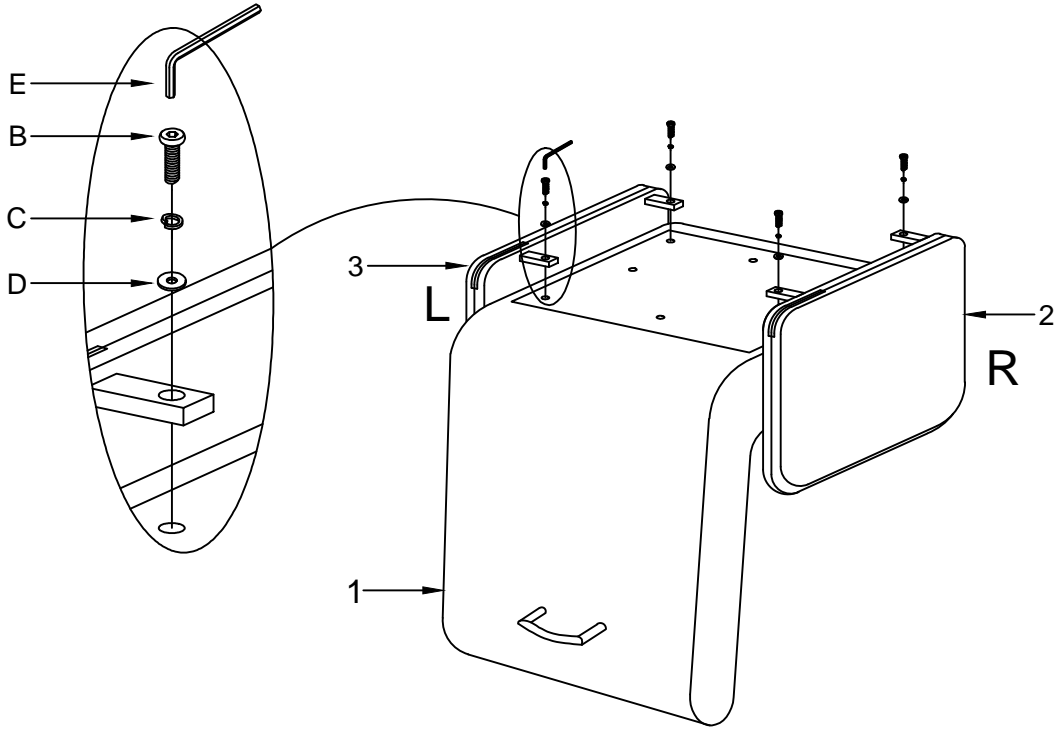

B	M6x30		4x
C	M6		4x
D	Ø18xØ6x1.5		4x
E	4MM		1x

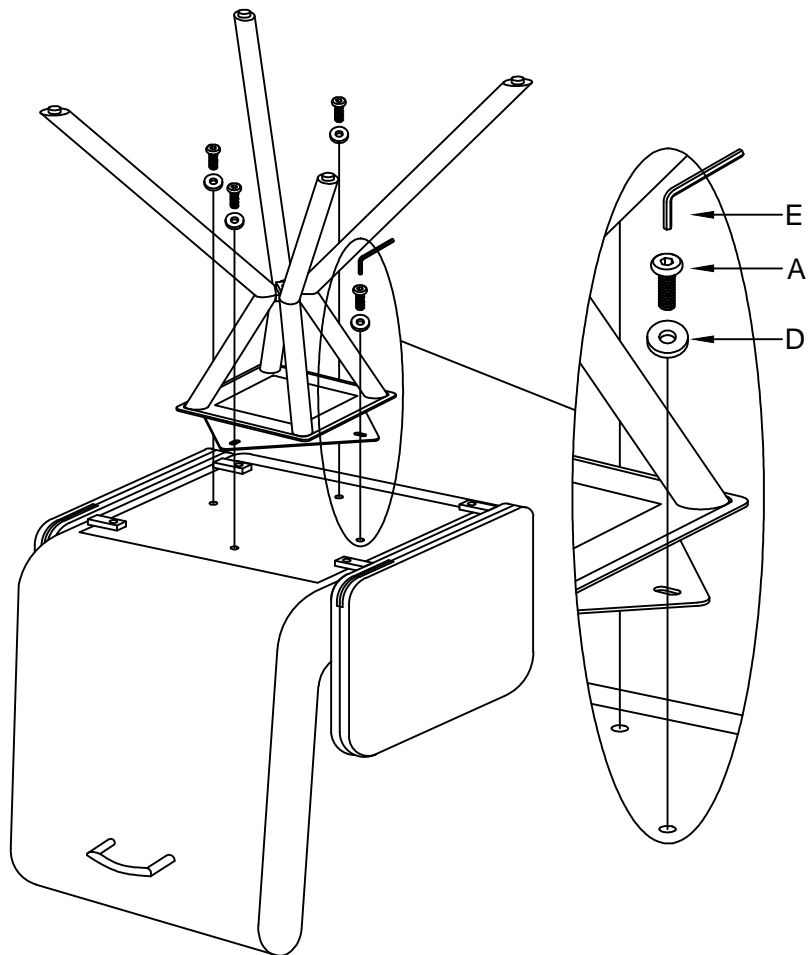

## 4



A	M6x20		4x
D	Ø18xØ6x1.5		4x
E	4MM		1x

III.

5

E		4MM
		1x
		

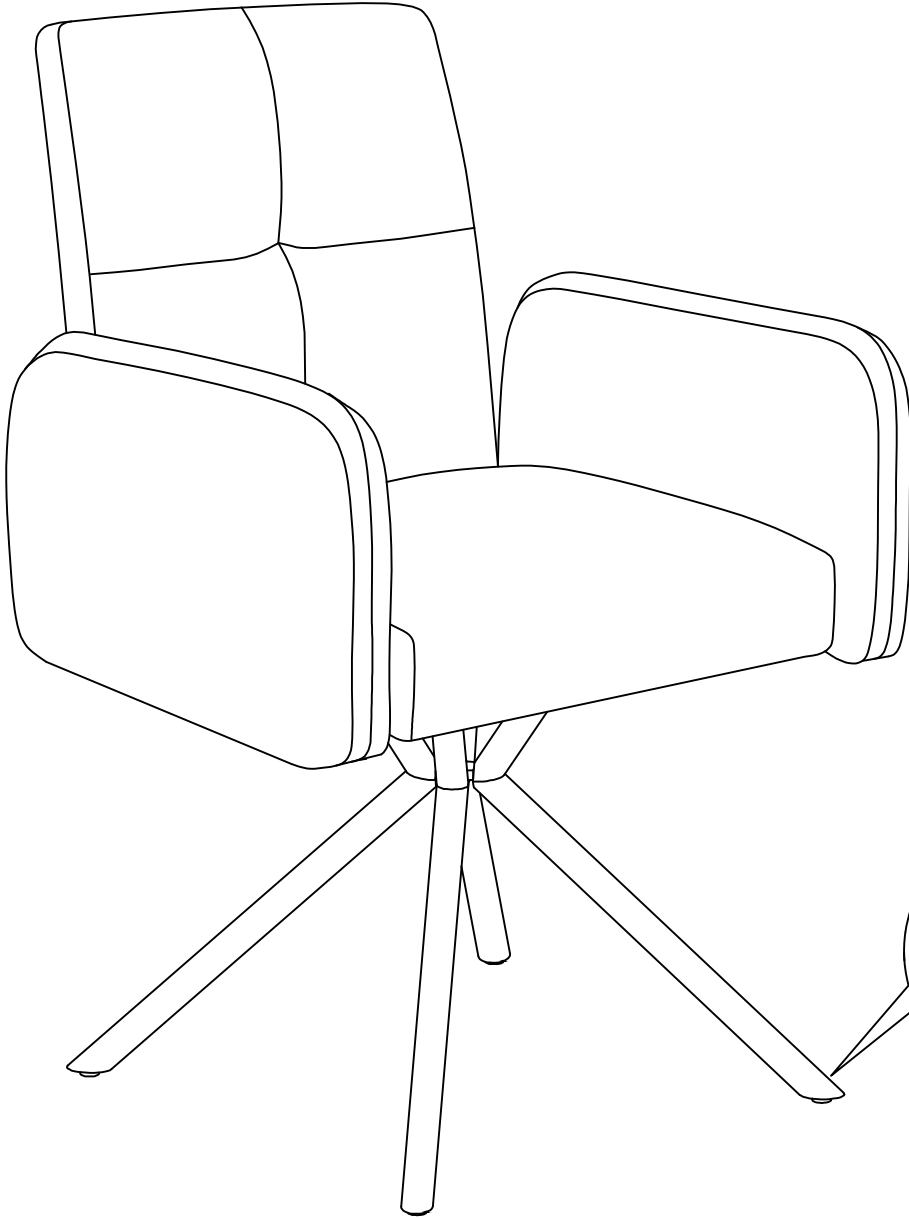

**LE TRI  
+ FACILE**



**BAC  
DE  
TRI**

*Séparez les éléments avant de trier*