

Olivia

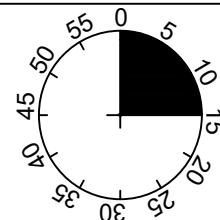
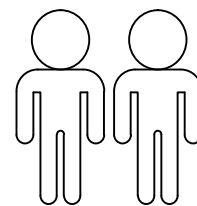
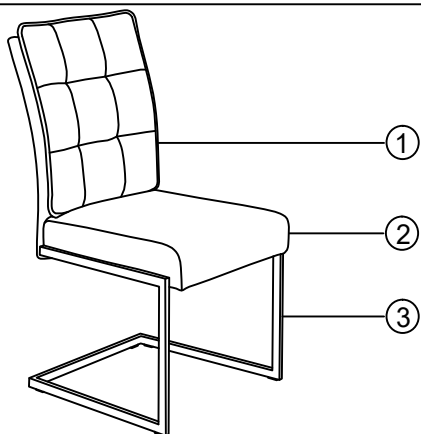

1

2

3

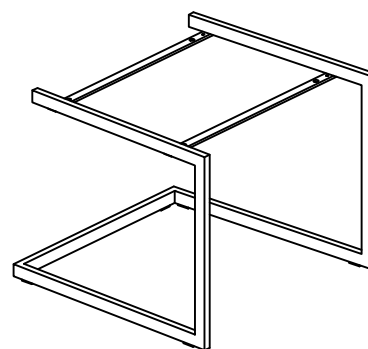
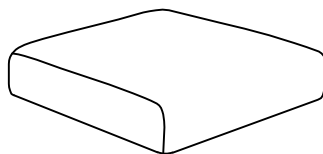
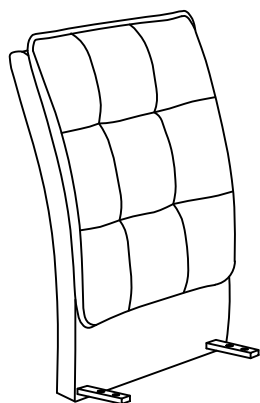

1	1x
2	1x
3	1x

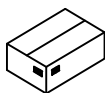



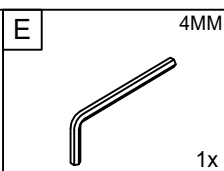
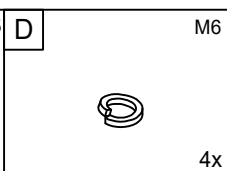
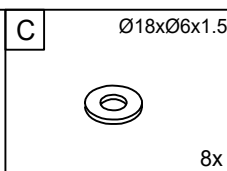
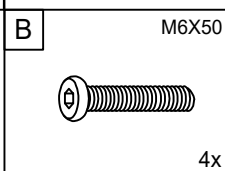
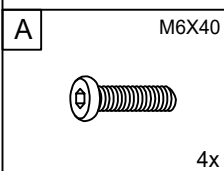



1/1

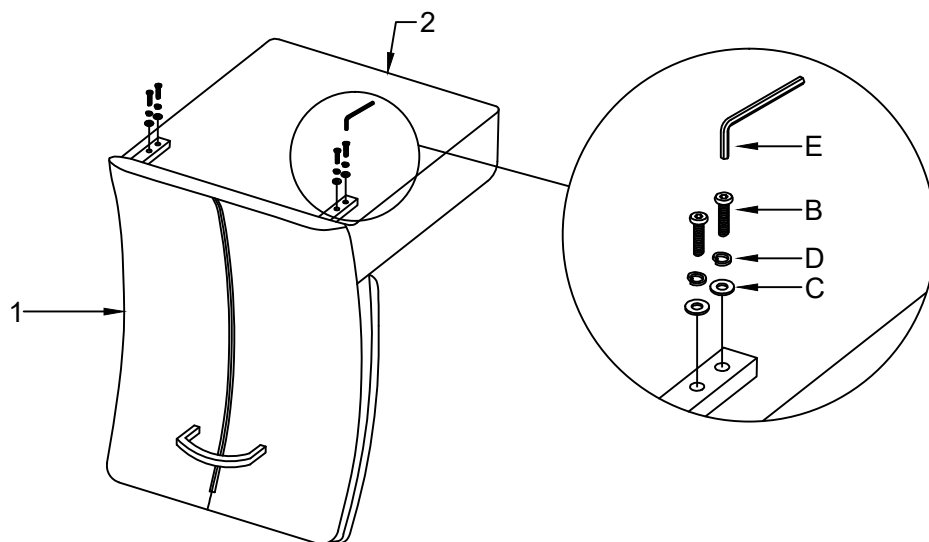

I.





1

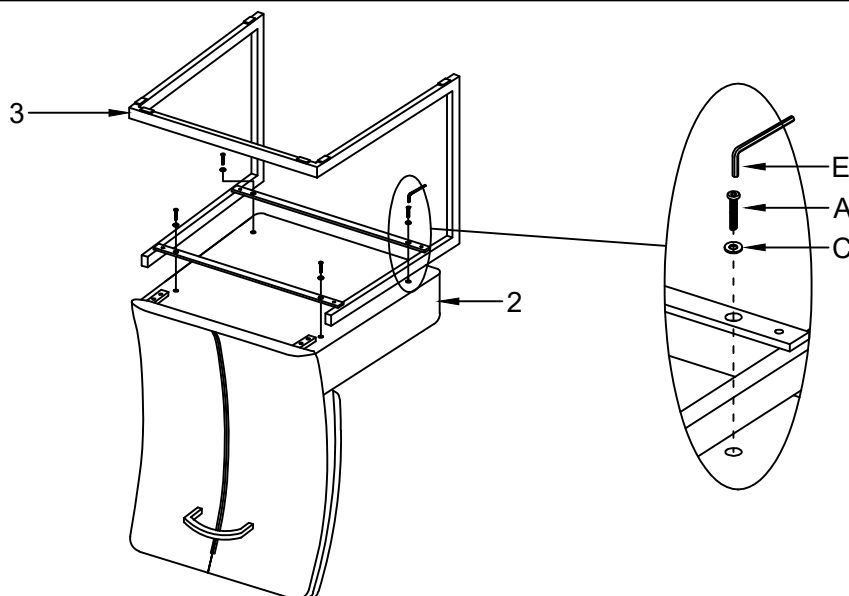

- B** M6X50
 4x
- C** Ø18xØ6x1.5
 4x
- D** M6
 4x
- E** 4MM
 1x
- 



2

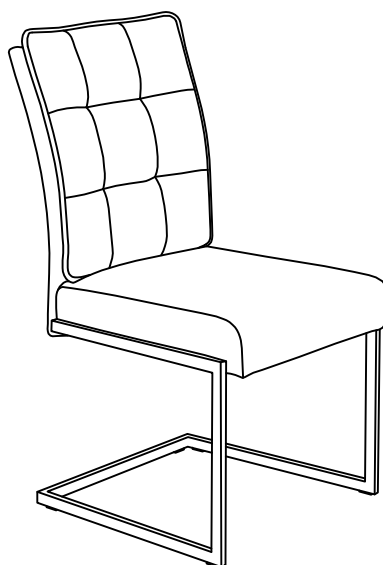

- A** M6X40
 4x
- C** Ø18xØ6x1.5
 4x
- E** 4MM
 1x
- 

3



- E** 4MM
 1x
- 



Séparez les éléments avant de trier