

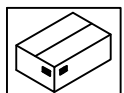

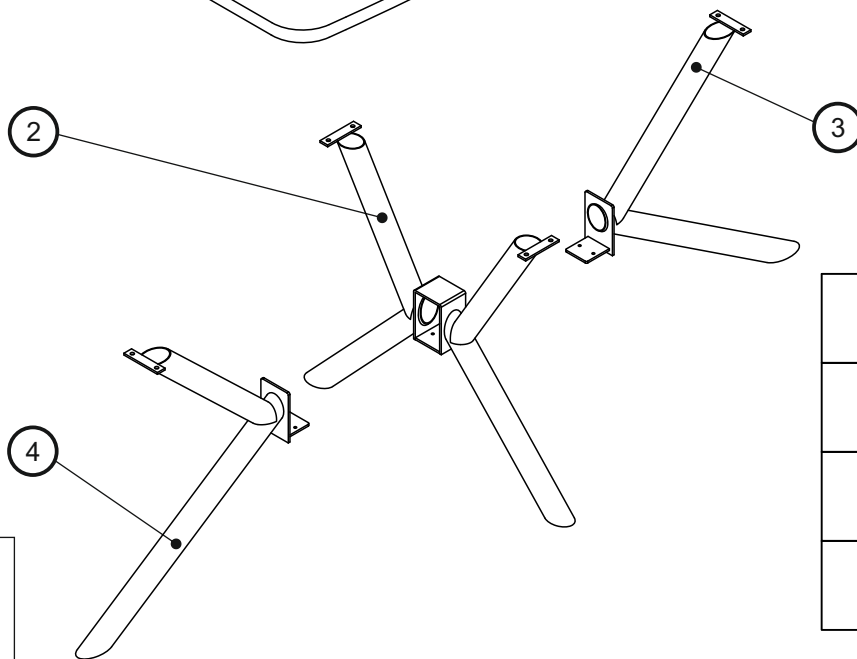

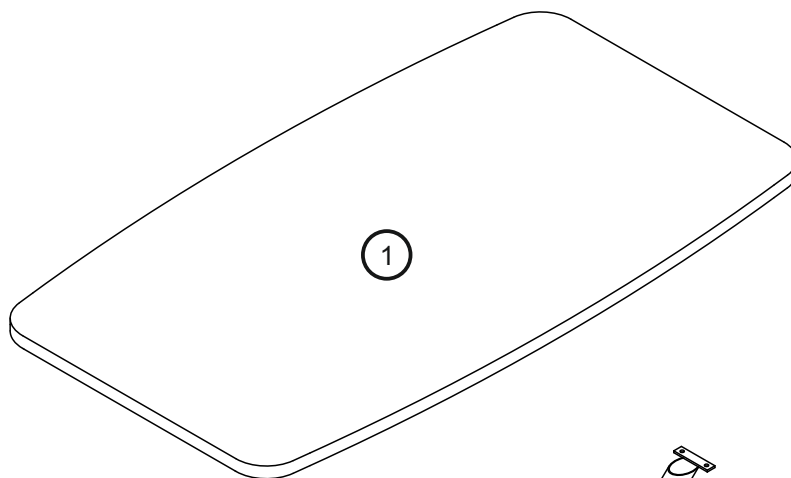

JANA T / JANA II T

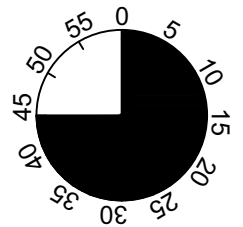
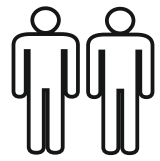
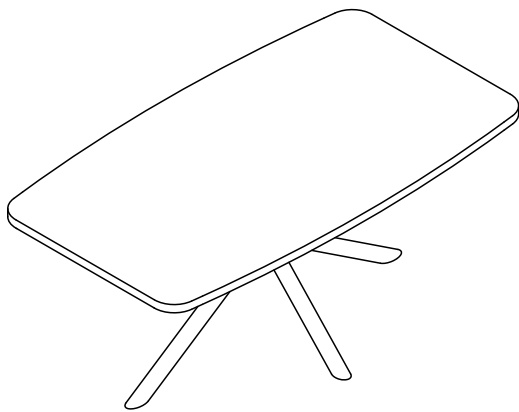
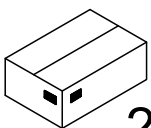

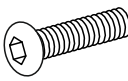
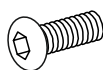
1	1X	1/2
2	1X	2/2
3	1X	2/2
4	1X	2/2

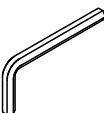

2/2

A	M8x25	B	M8x16	C	Ø17xØ8x1,5	D	Ø15xØ8x2,3	E	M8x12,5	F	5MM
	2x		8x		10x		2x		8x		1x
G	8MM	H	Ø34xM8								
	1x		4x								

I.

1.

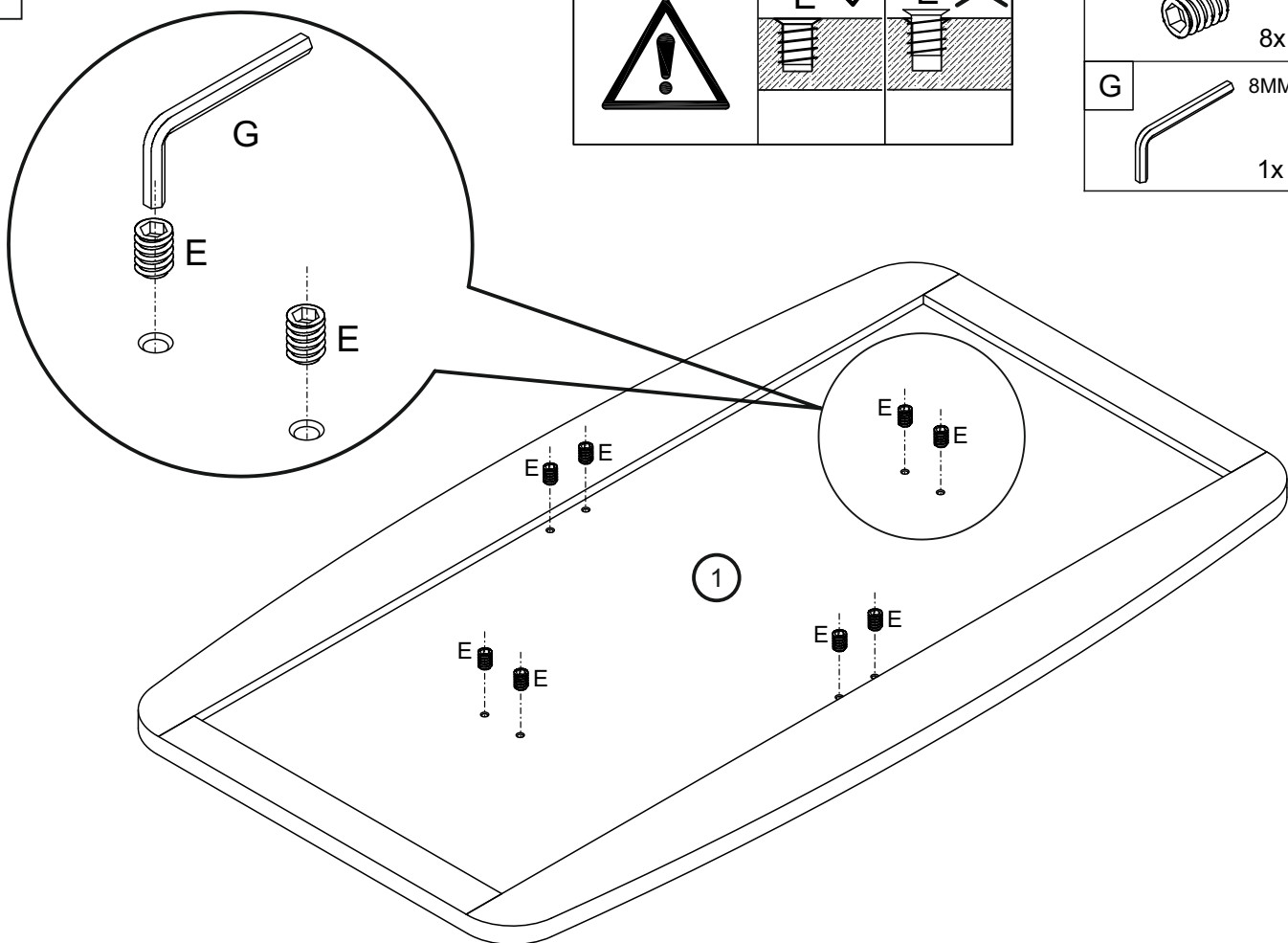

2.

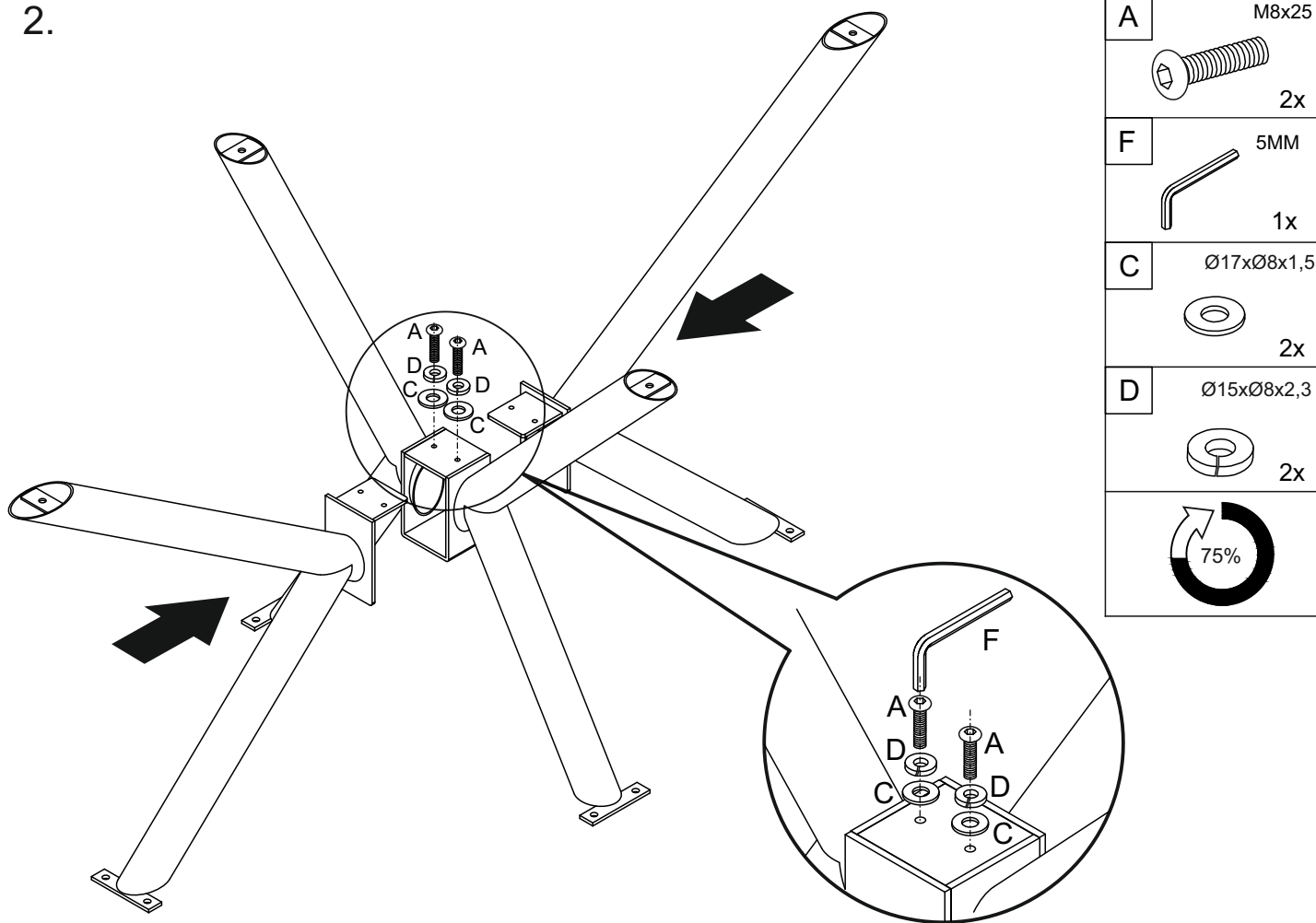

II.

3.

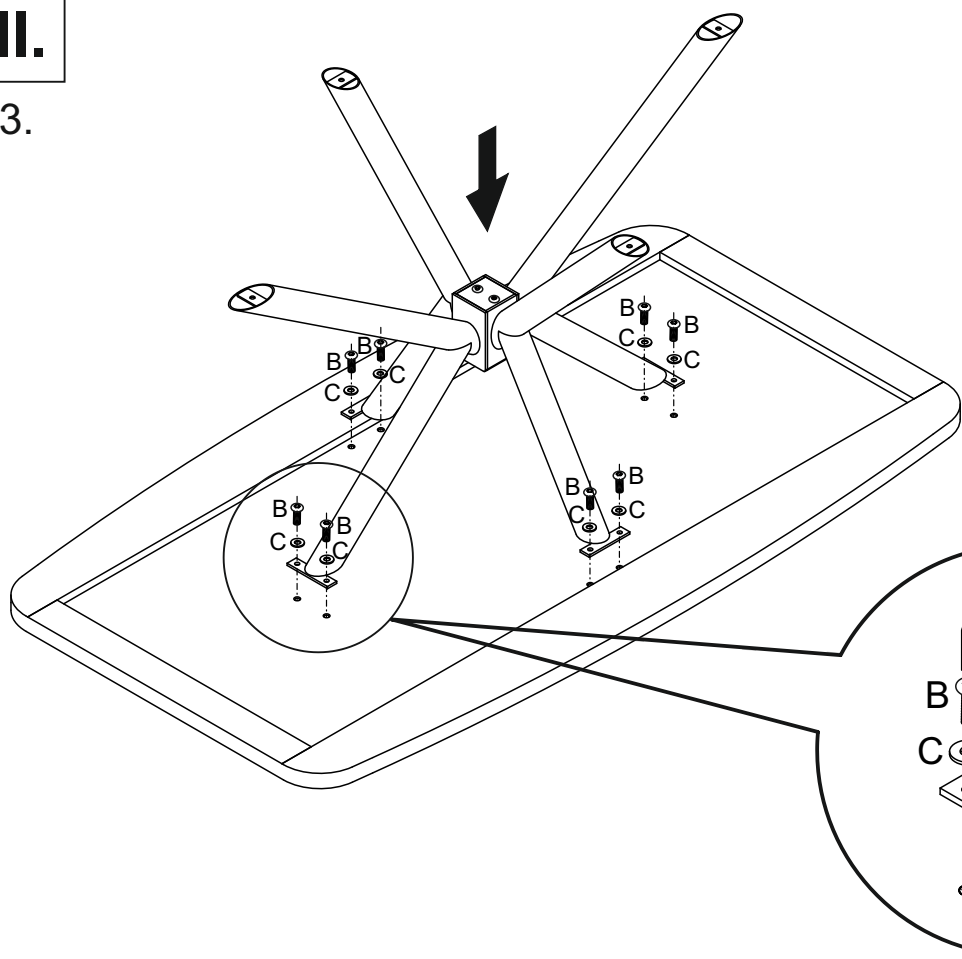

B	M8x16
	8x
F	5MM
	1x
C	Ø17xØ8x1,5
	8x

4.

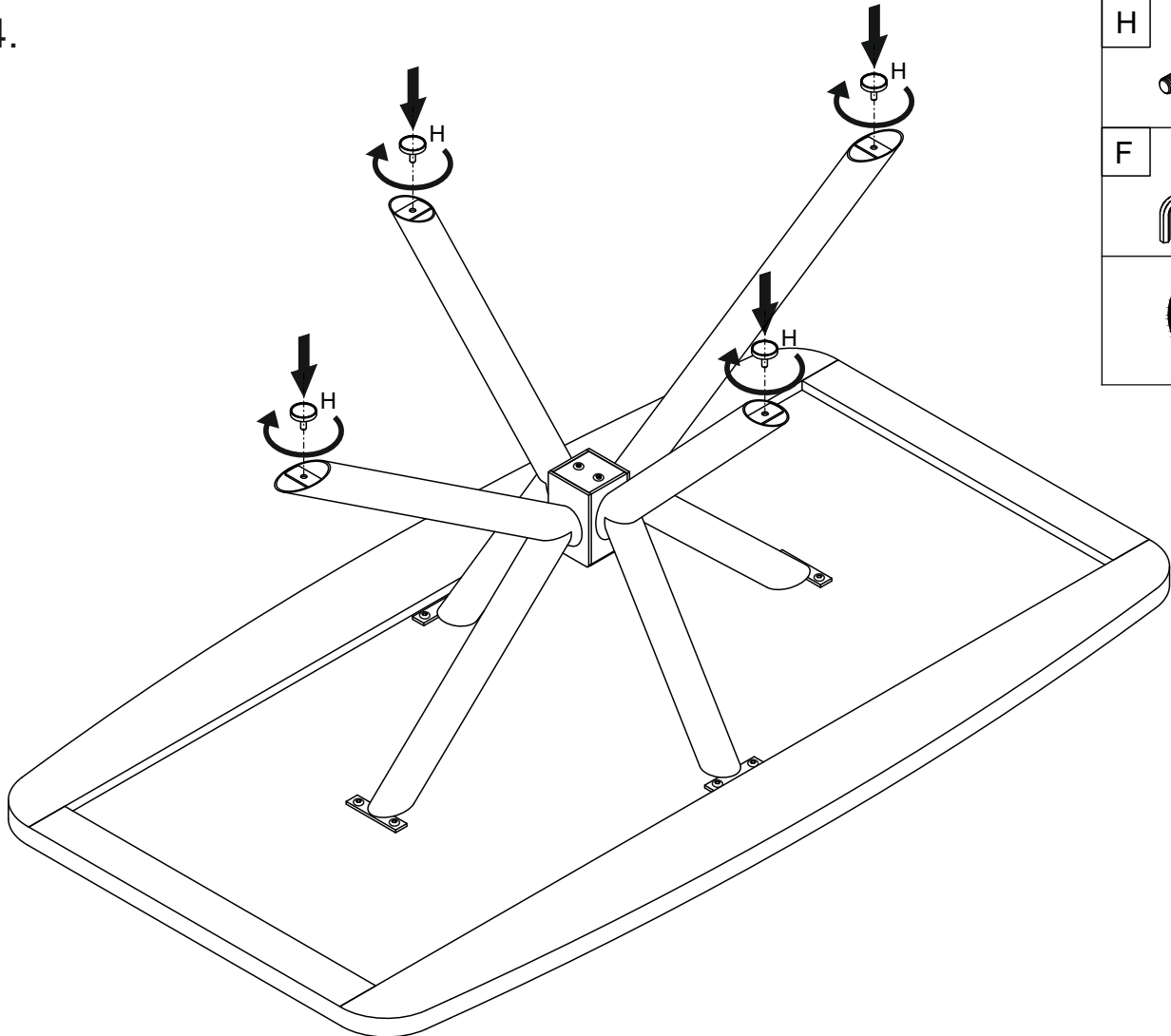

H	Ø34xM8
	4x
F	5MM
	1x

III.

5.

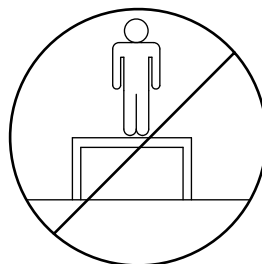
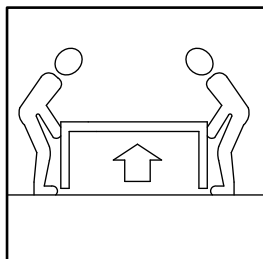
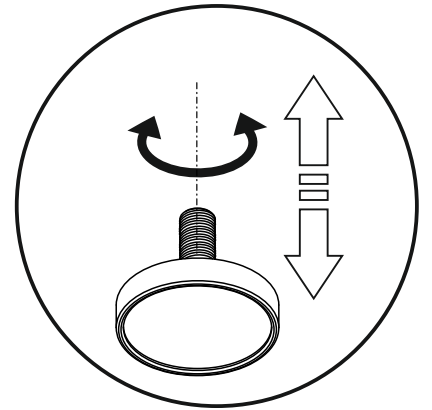
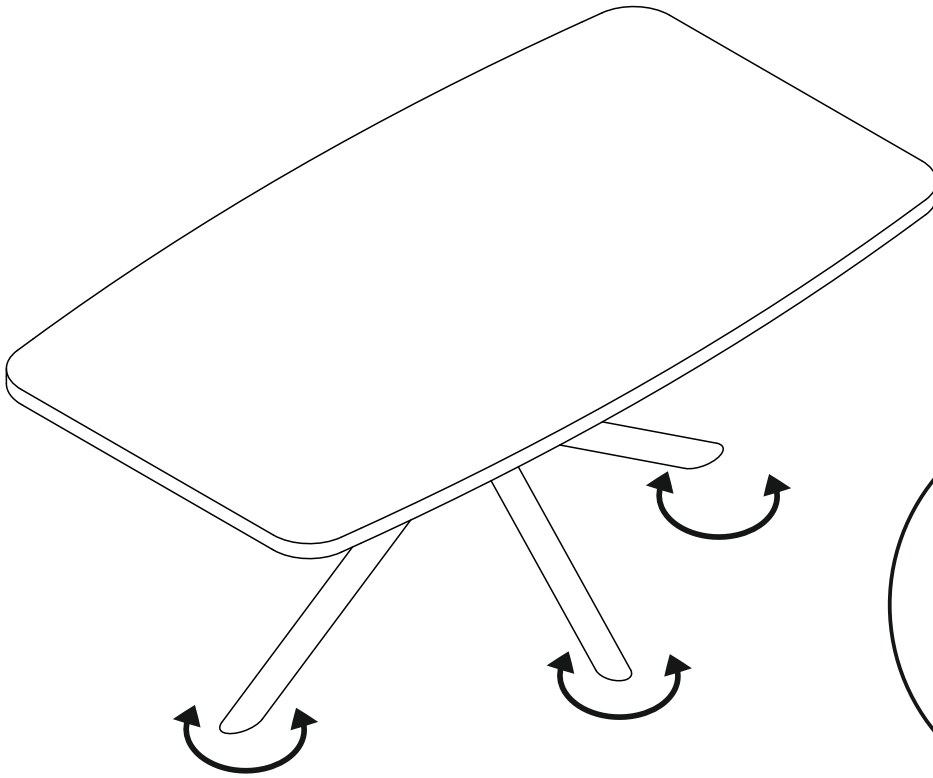
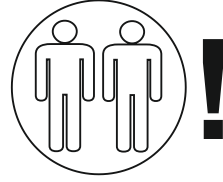
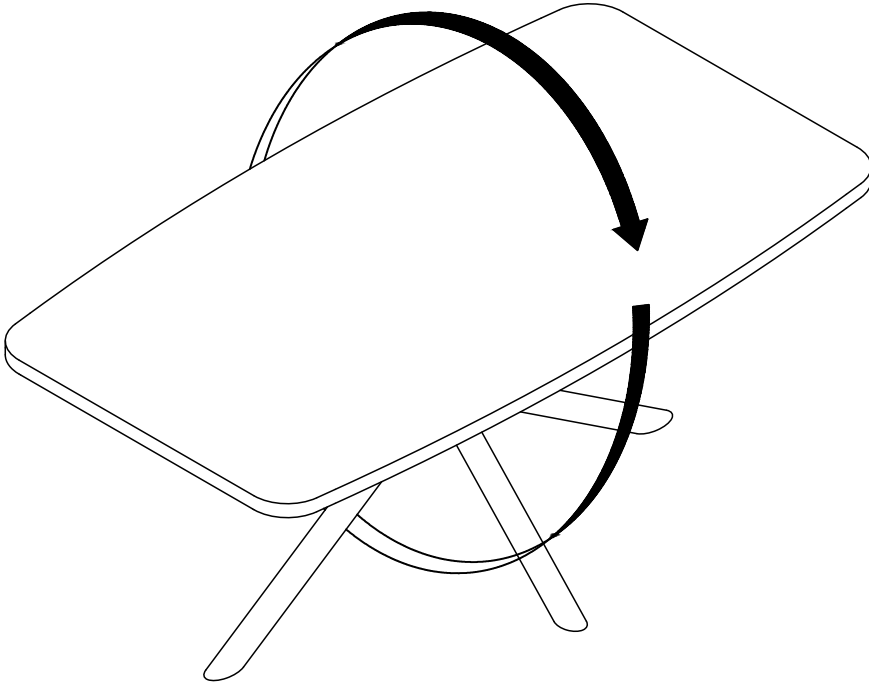

LE TRI + FACILE  

Séparez les éléments avant de trier