

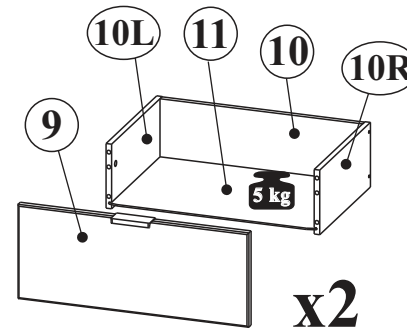

B - 1340mm
H - 507mm
T - 374mm

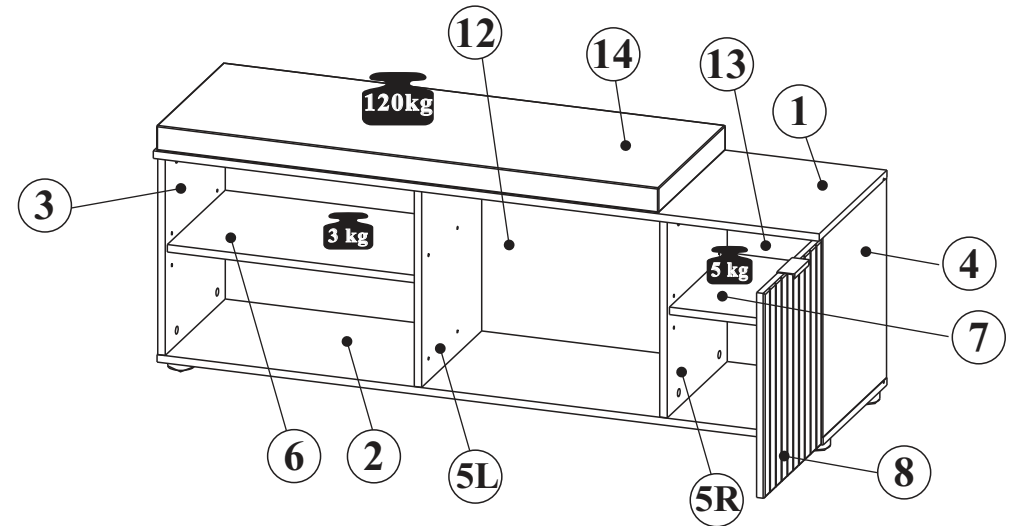

| | | | | |
|---------|------|-----|---|-----|
| 1 | 1340 | 374 | 1 | 1/2 |
| 2 | 1340 | 353 | 1 | 1/2 |
| 3 | 402 | 352 | 1 | 2/2 |
| 4 | 402 | 352 | 1 | 2/2 |
| 5L,5R | 402 | 332 | 2 | 2/2 |
| 6 | 501 | 320 | 1 | 2/2 |
| 7 | 298 | 320 | 1 | 2/2 |
| 8 | 412 | 316 | 1 | 1/2 |
| 9 | 500 | 204 | 2 | 1/2 |
| 10L,10R | 302 | 140 | 4 | 2/2 |
| 10 | 439 | 140 | 2 | 2/2 |
| 11 | 450 | 300 | 2 | 2/2 |
| 12 | 1007 | 411 | 1 | 1/2 |
| 13 | 310 | 411 | 1 | 1/2 |
| 14 | 1010 | 370 | 1 | 1/2 |

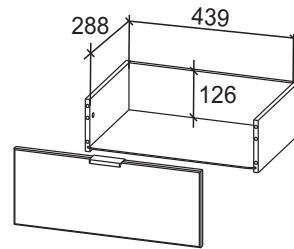
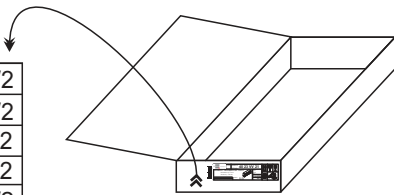



NR 1

B1  ϕ 8x28 x16

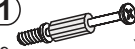
M1  ϕ 15x12mm x16

T1  5x39mm x16

W1  x4

W8  x4

J23  x14

P2  3x20 x4

F1  x2

C14  ϕ 20mm x12

NR 2

X11  ϕ 35 x2

Kr0

PC  H0 x2

E3  6,3x13 x4

S8  4x13 x4

NR 3

F10  x6

P4  4x25 x6

NR 4

U180  x3

S3A  3,5x13 x6

NR 5

J11  x1

P13  3,5x13 x2

T13  8x50 mm x1

T14  6x50 mm x1

NR 6

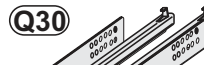
Q30  L-300mm x2L/2R

E24  6,0x11 x8

S3  3,5x13 x8

P5  4x30 x8

M2  ϕ 12x10mm x4

T2  5x32mm x4

S4  3x16 x4

J23  x4

C 1/2

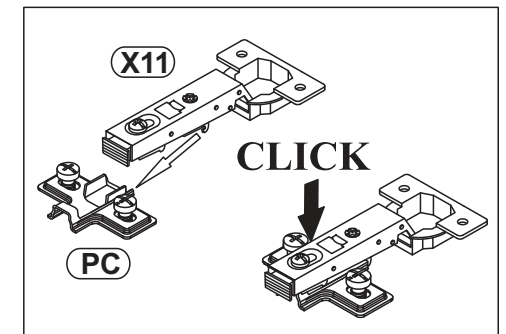
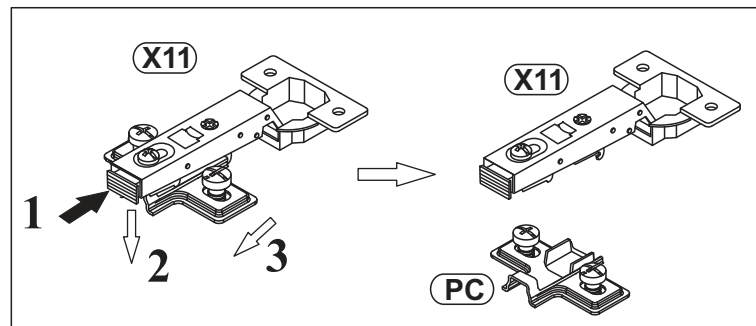

1

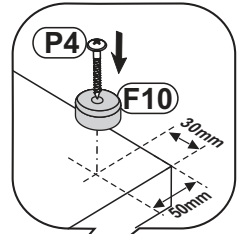
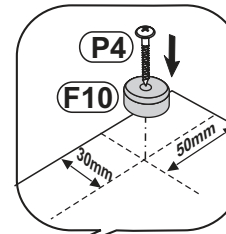
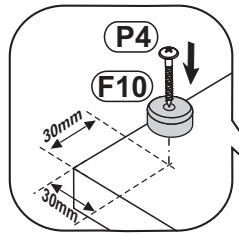
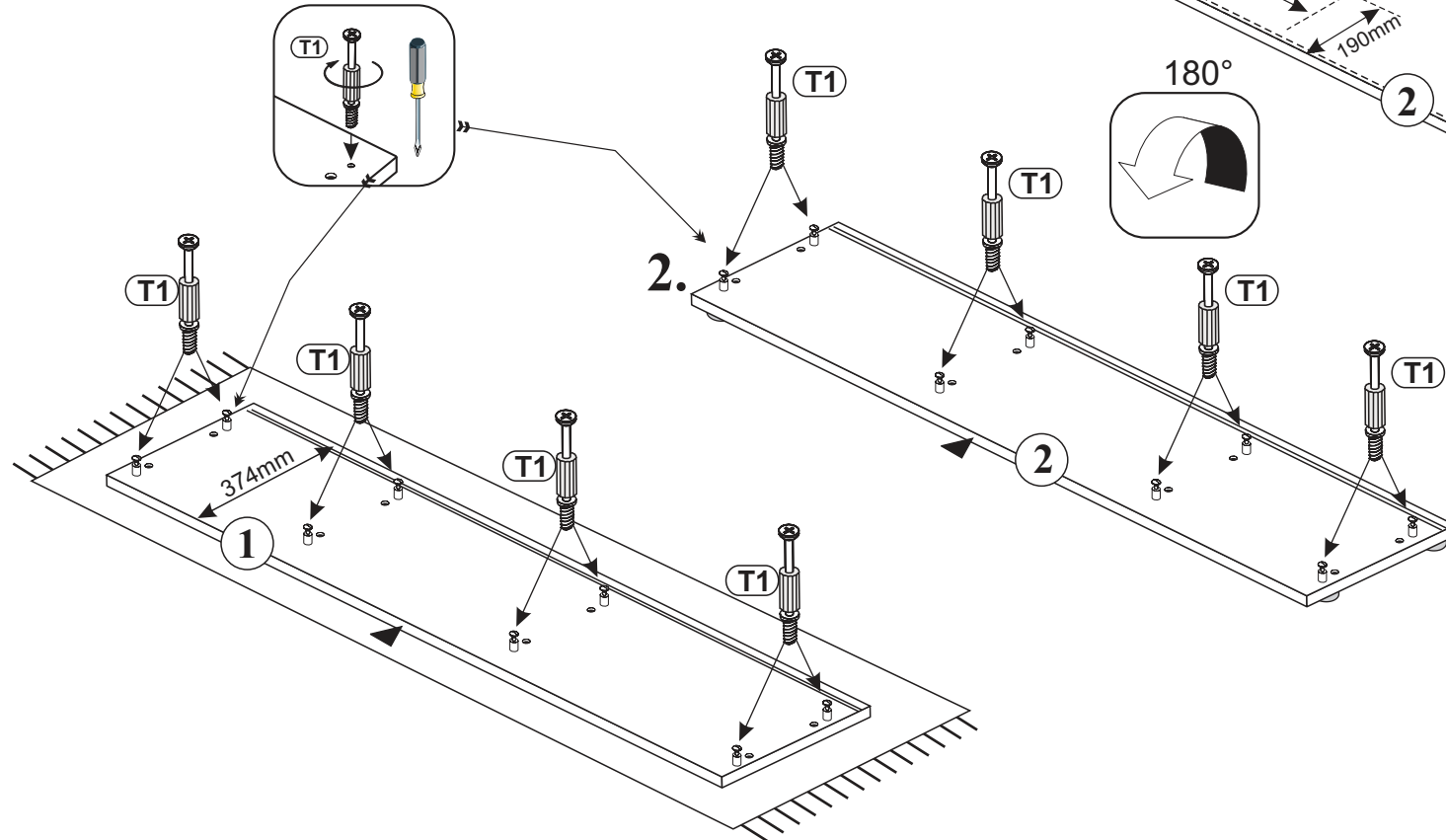
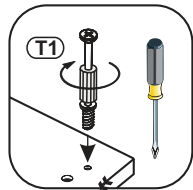
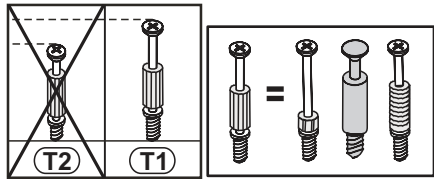
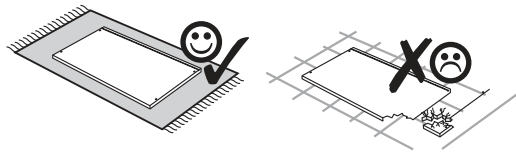
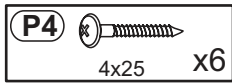
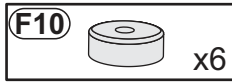
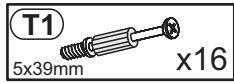

2

- M1** $\phi 15 \times 12 \text{mm}$ x8
- PC** x2
- W1** x2
- B1** $\phi 8 \times 28$ x8
- E3** 6,3x13 x4
- W8** x2

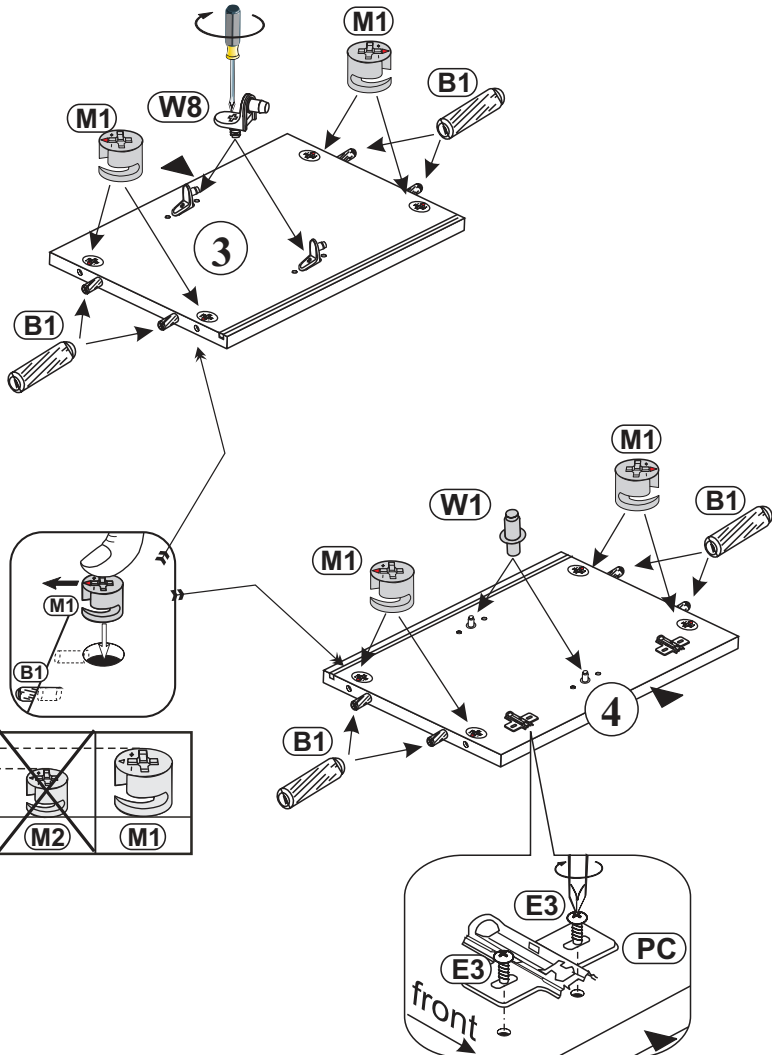

3

- M1** $\phi 15 \times 12 \text{mm}$ x4
- W8** x2
- Q30** L-300mm x2L
- B1** $\phi 8 \times 28$ x4
- E24** 6,0x11 x4
- S3** 3,5x13 x4

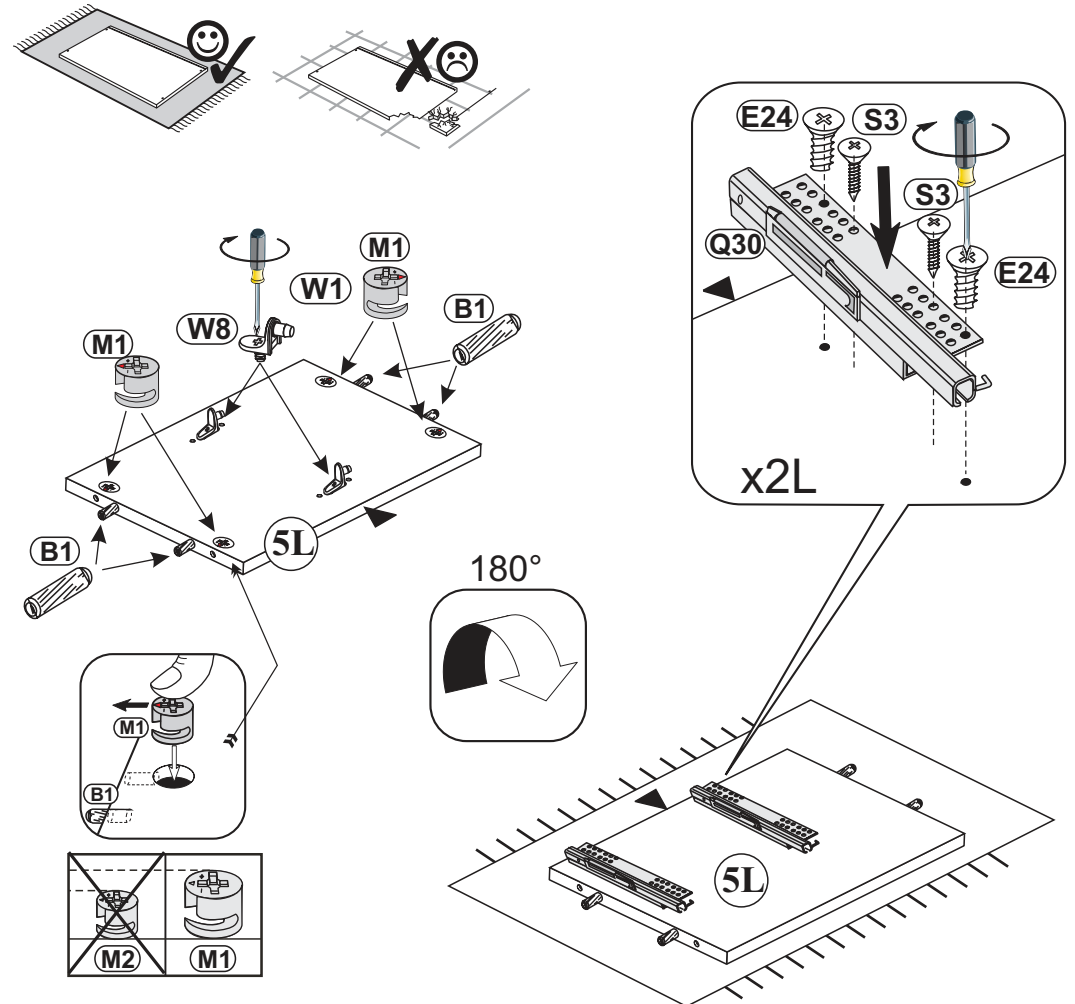

4

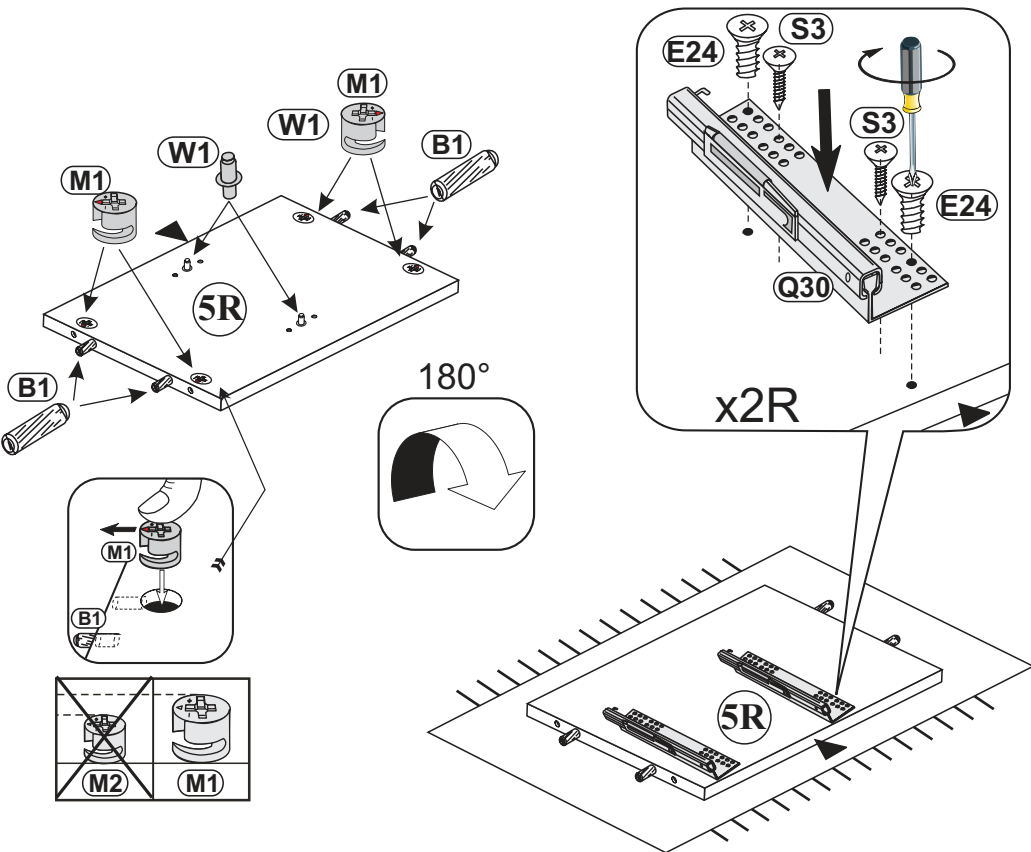
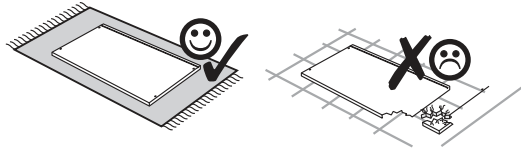
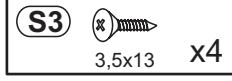
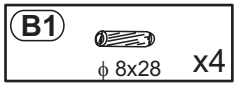
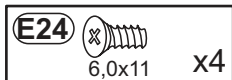
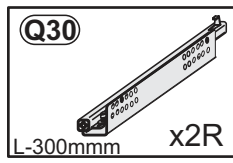
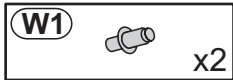

5

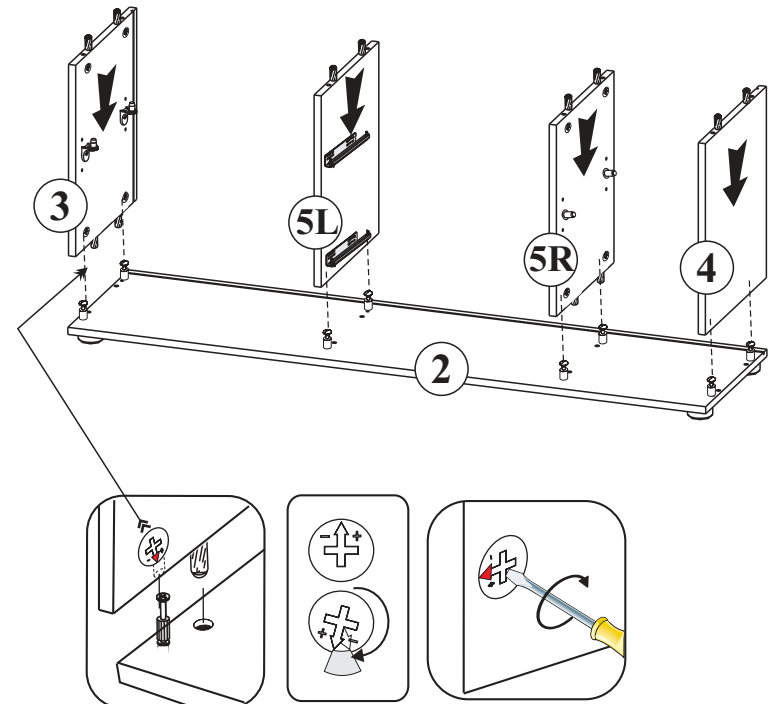

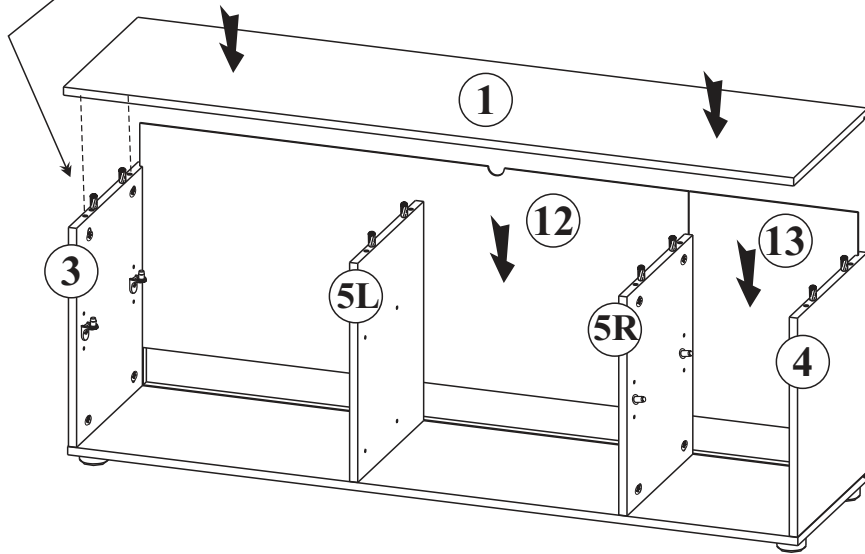
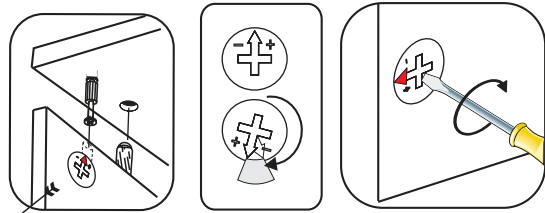

6

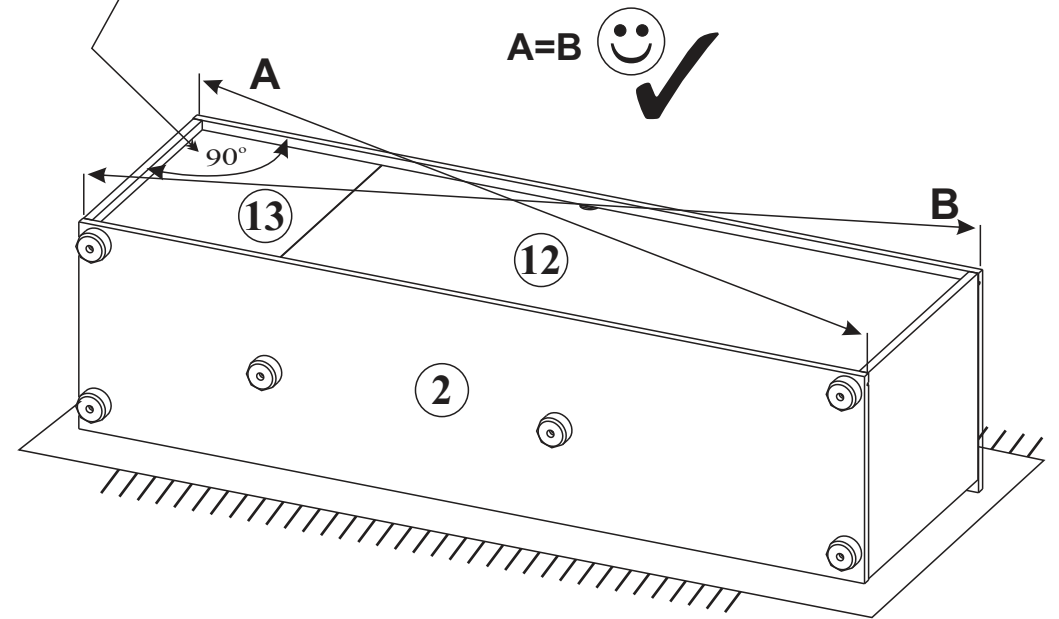
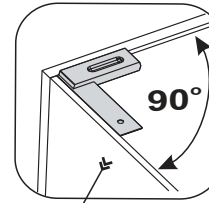
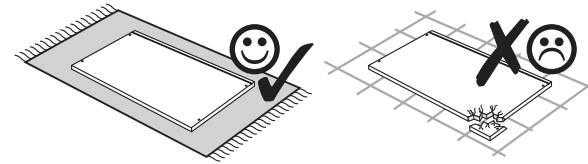

7





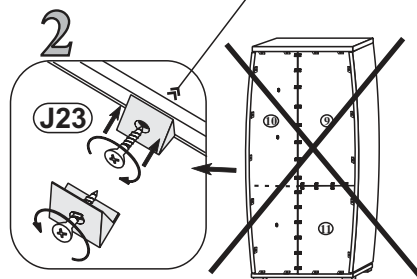
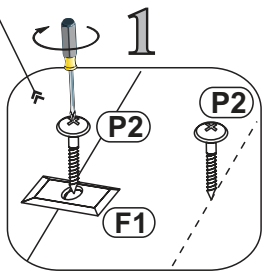
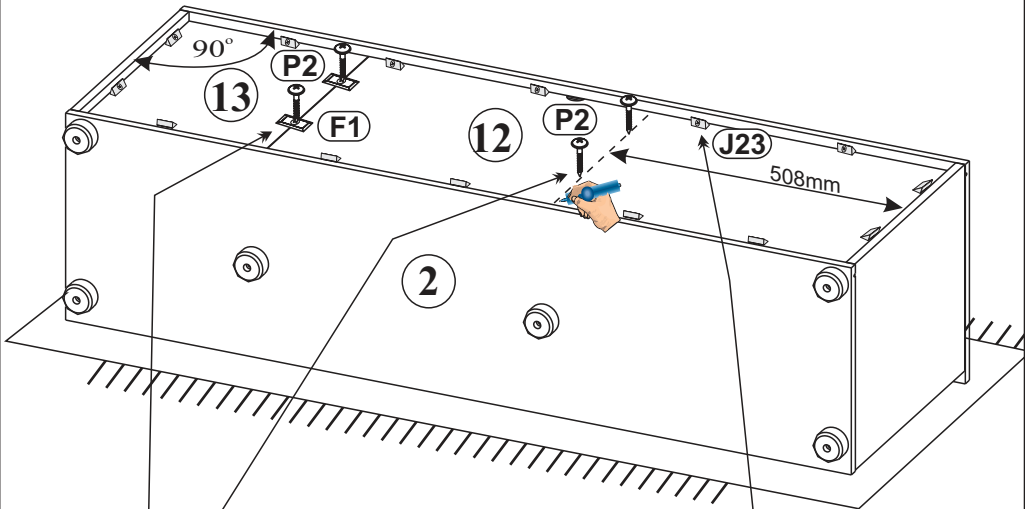
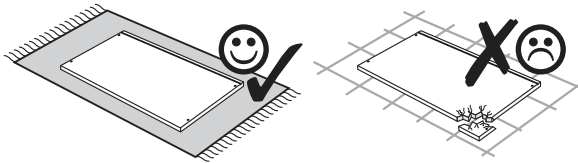

8

- J23**  x14
- P2**  3x20 x5
- F1**  x2



9

- J11**  x1
- T13**  8x50 mm x1
- P13**  3,5x13 x2
- T14**  6x50 mm x1

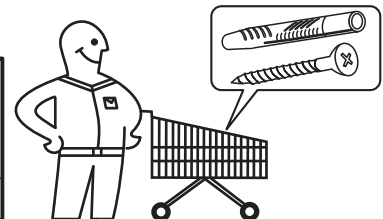
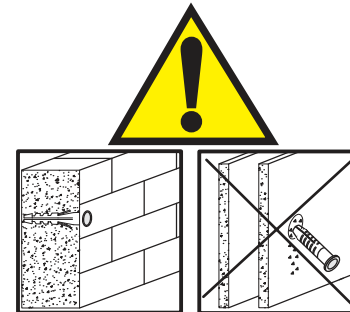
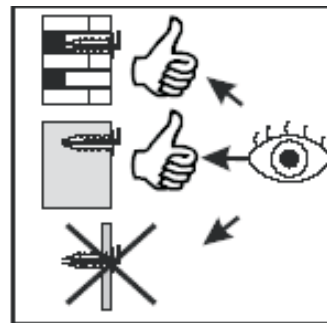
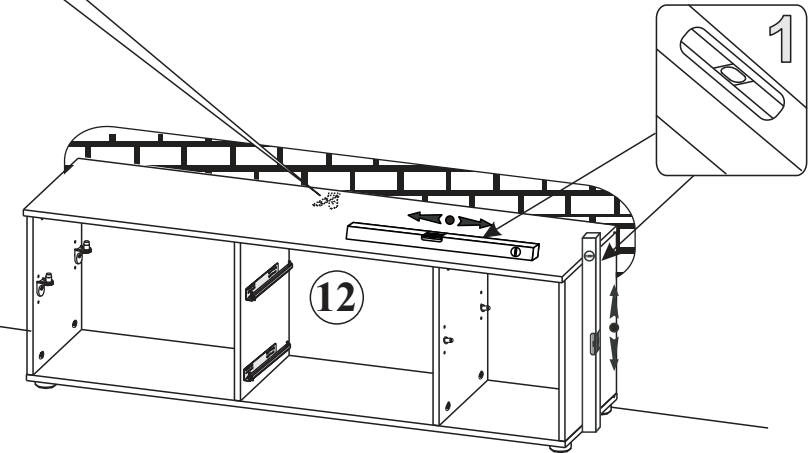
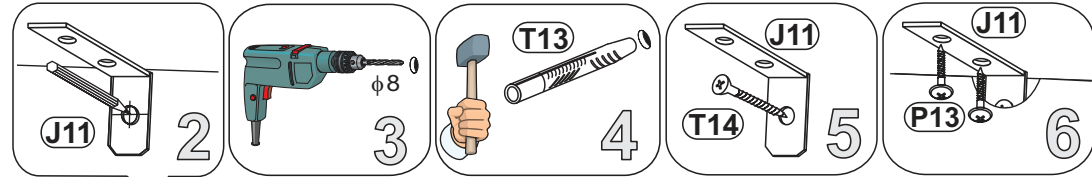

10

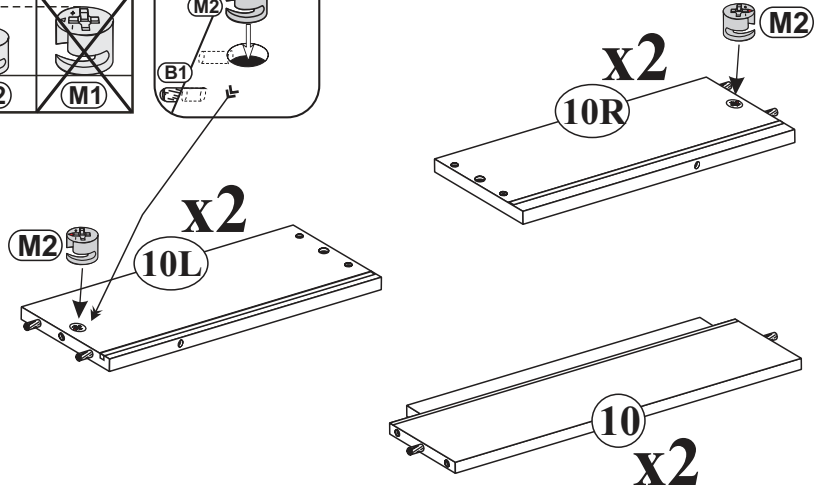
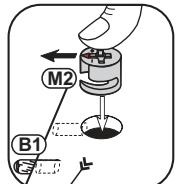
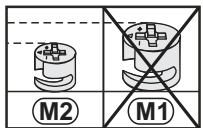
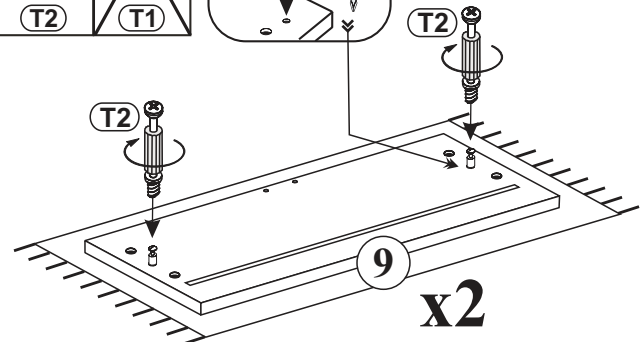
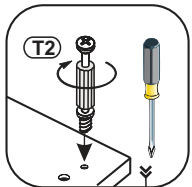
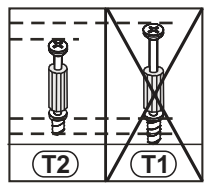
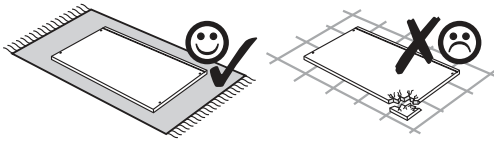
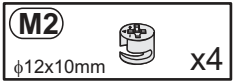

11

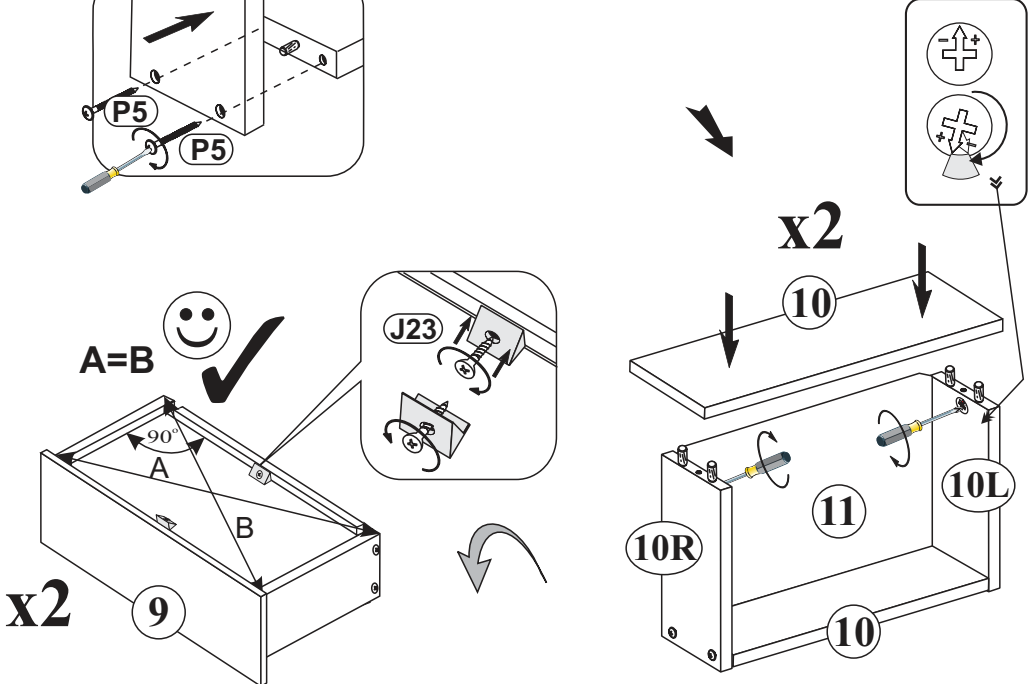
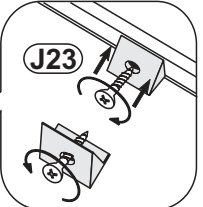
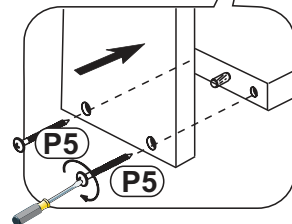
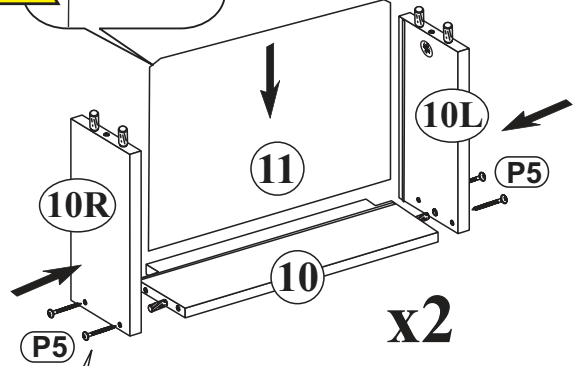
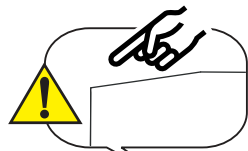
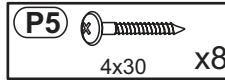

12

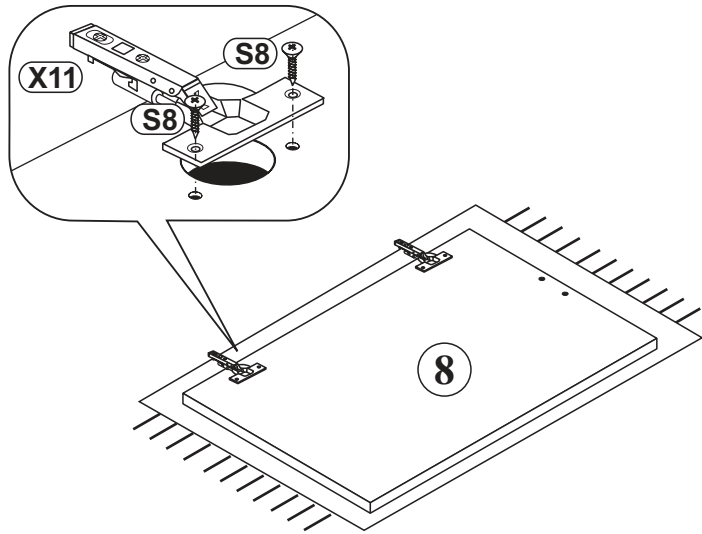
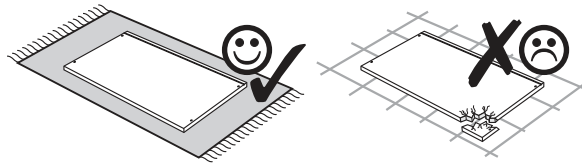
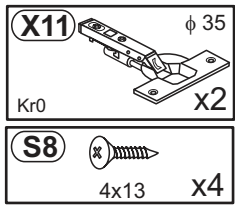

13

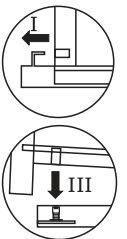
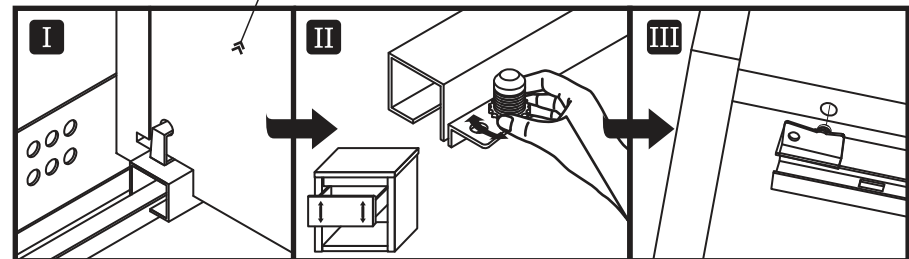
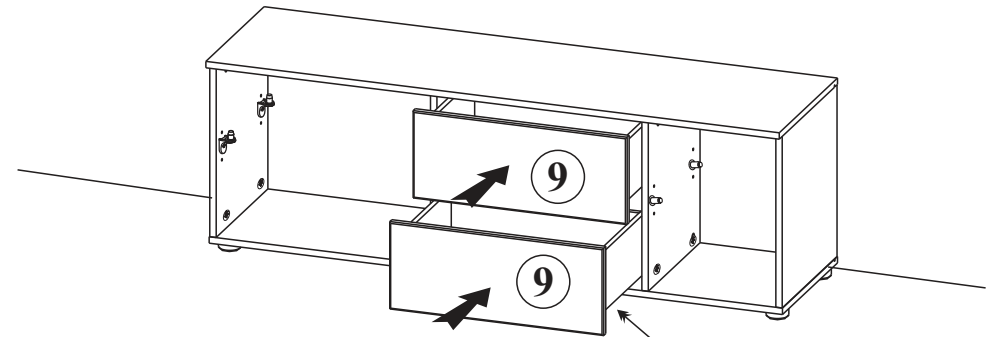

14

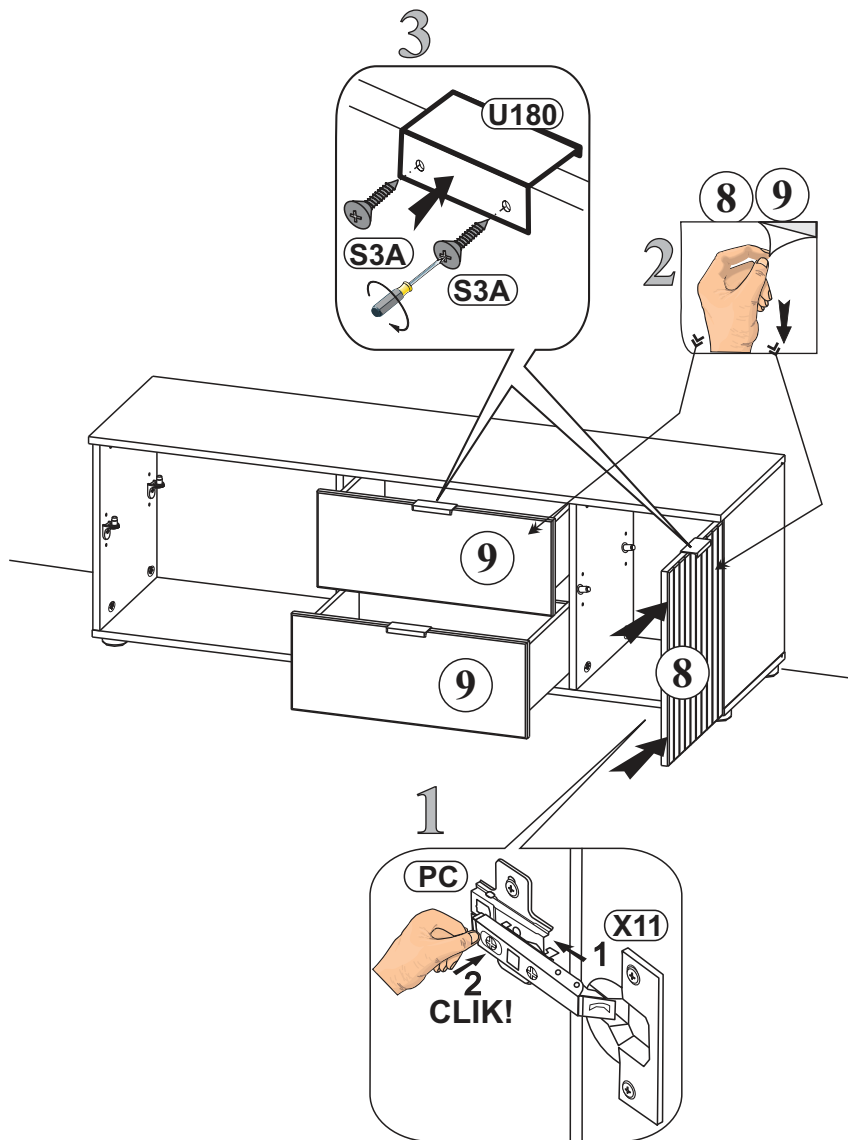
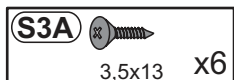
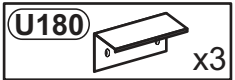

15

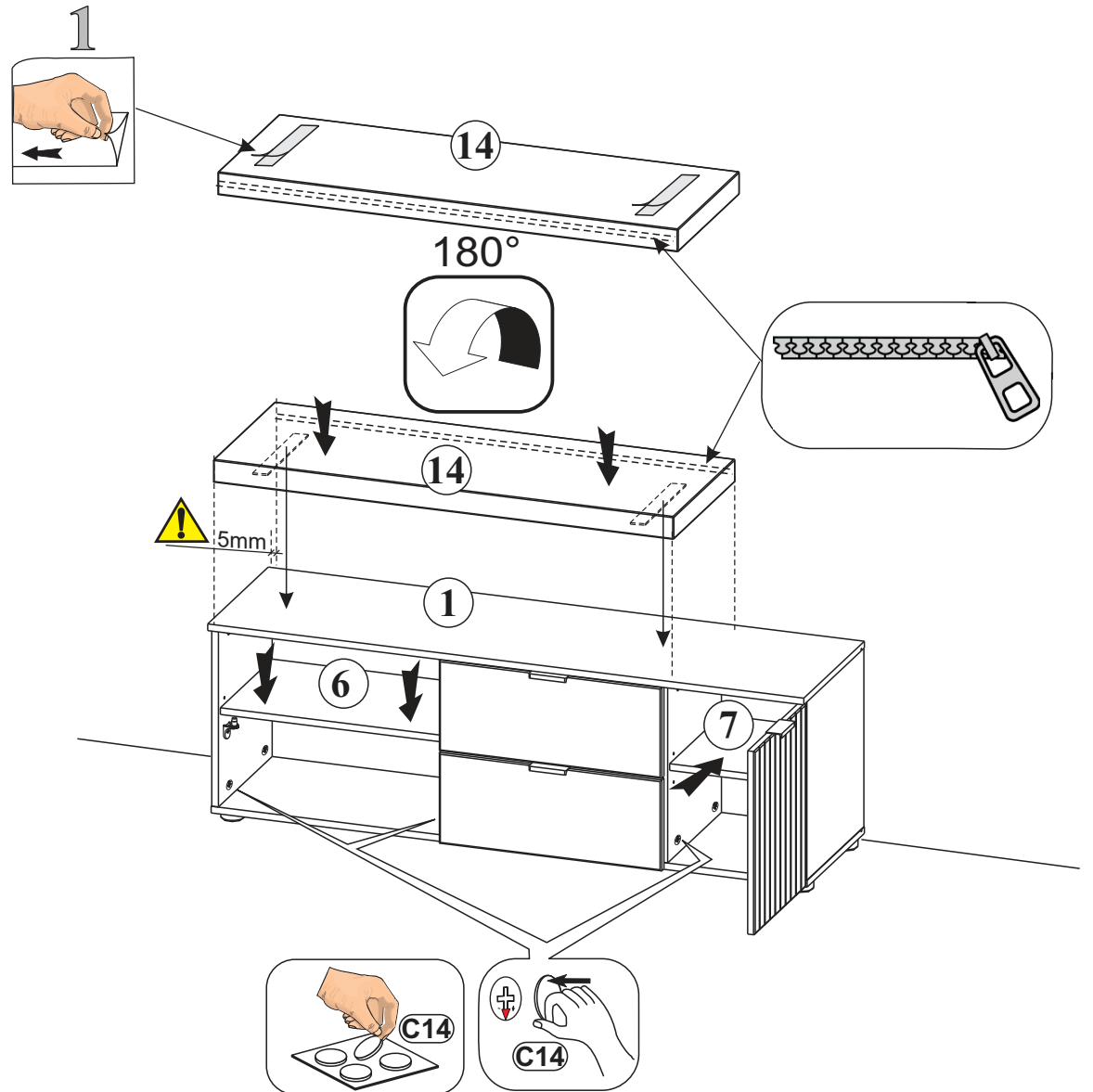
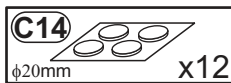

16

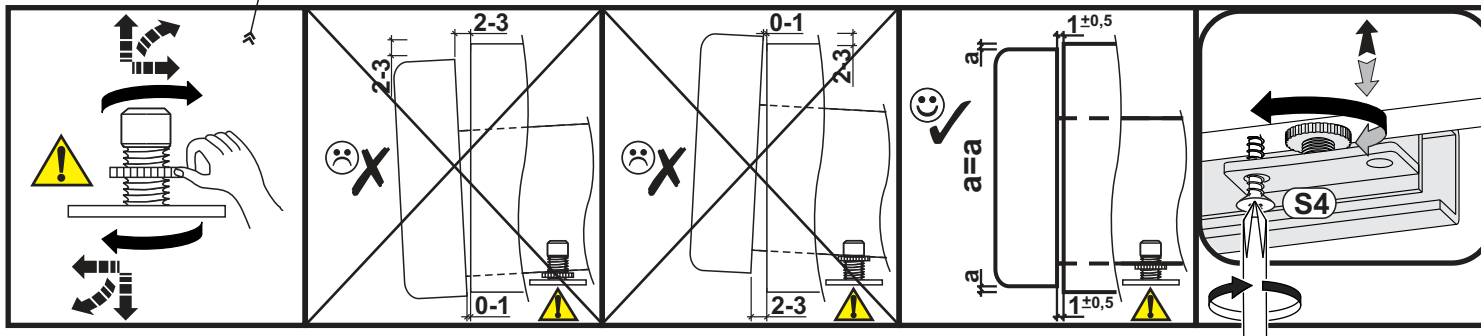
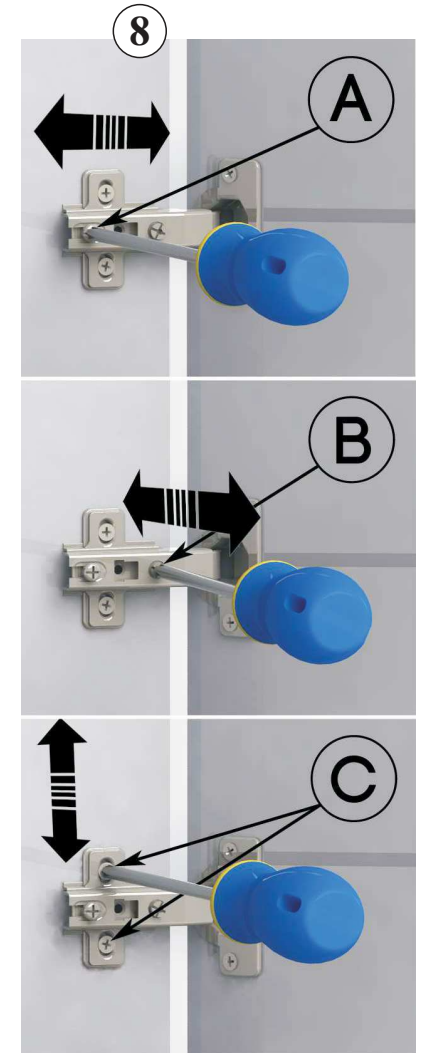
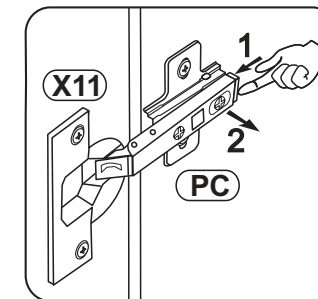
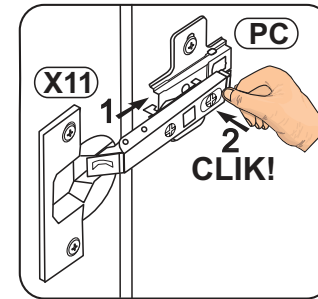
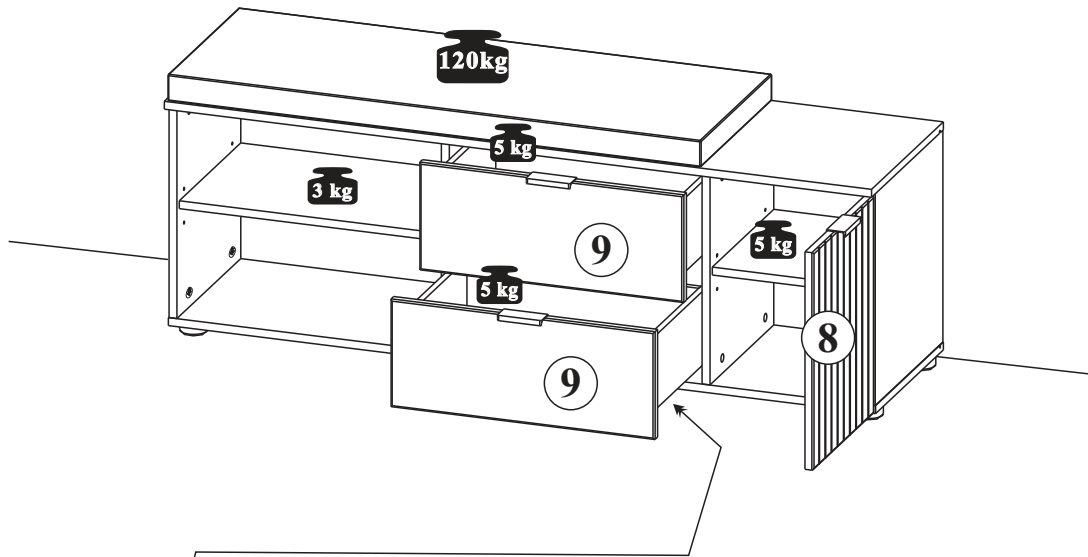
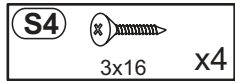

82

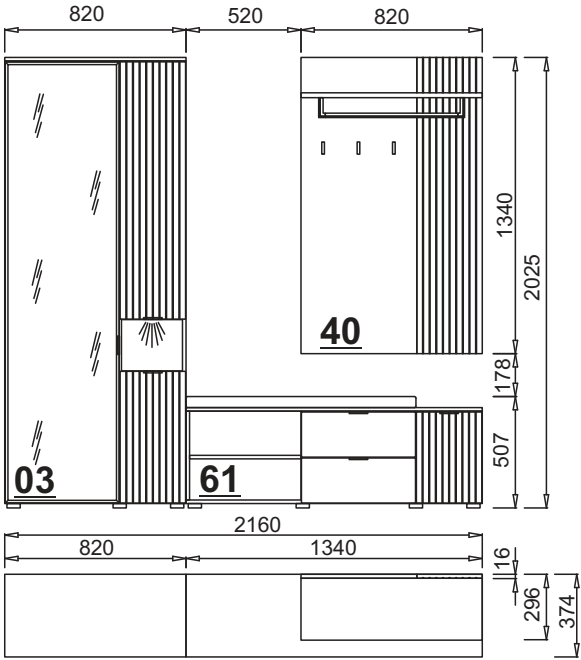

83

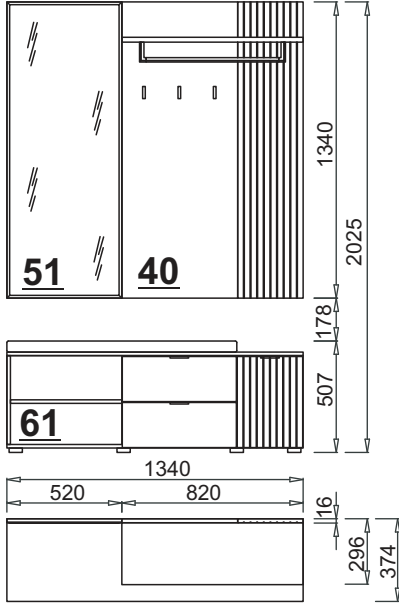

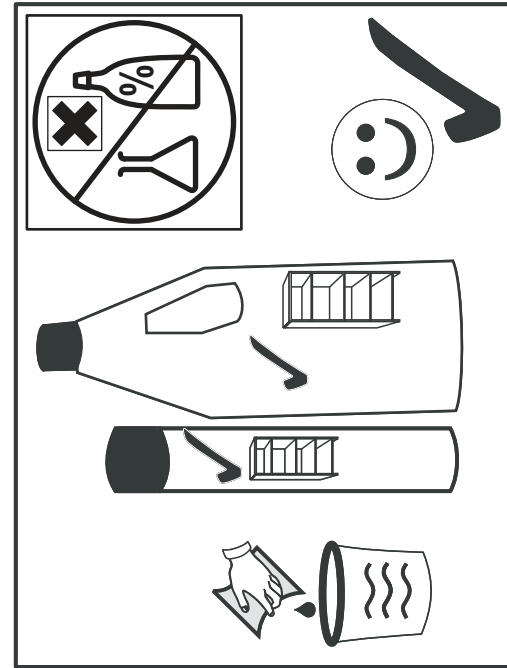
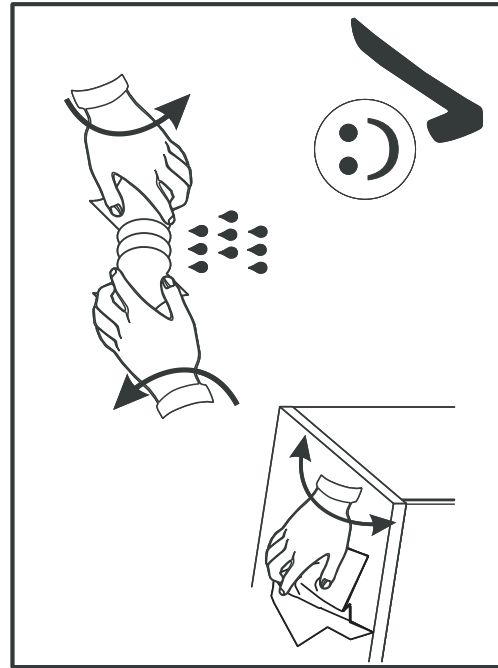
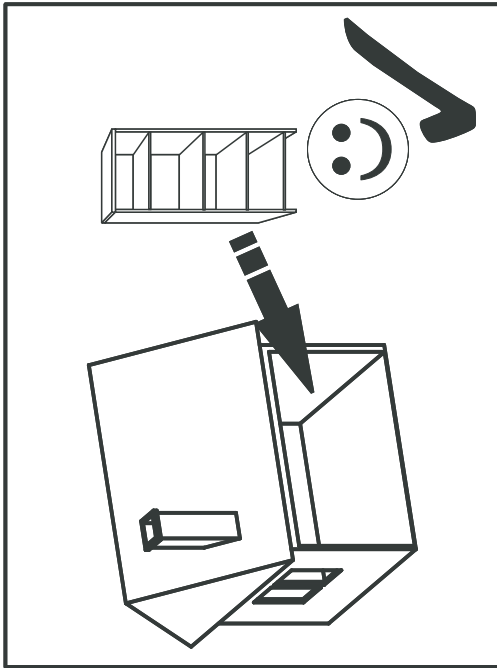
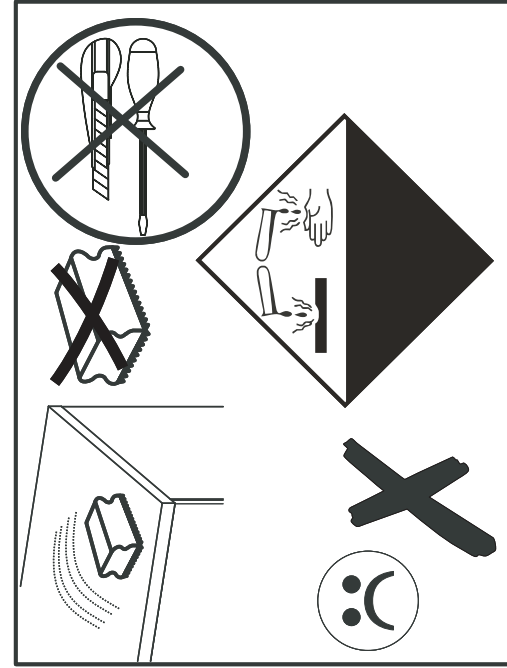
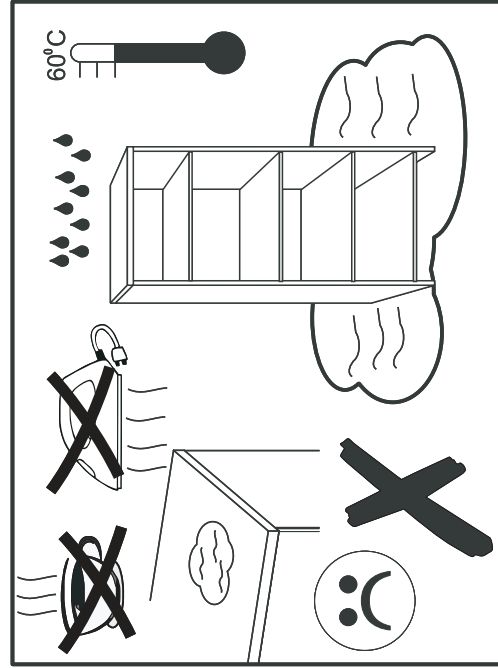
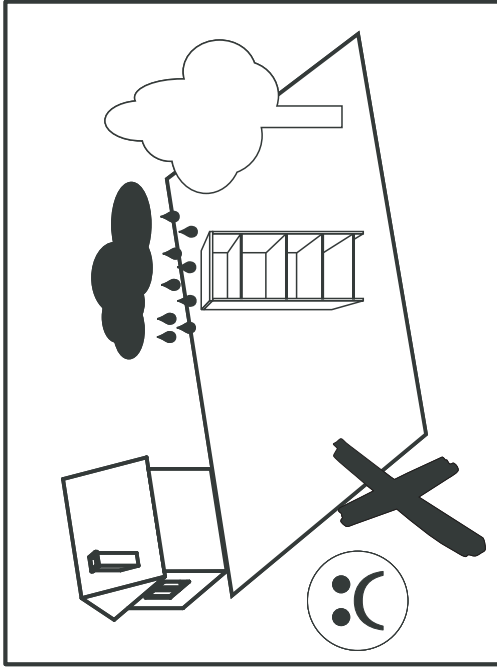
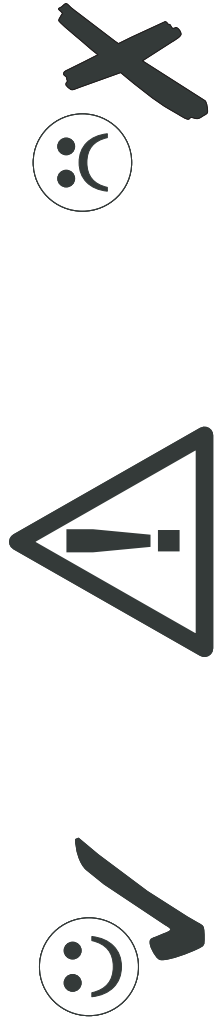

D CH AT LI LU Kleintelle und Verpackungsfolien bei der Möbelmontage von Kindern fernhalten!
GB US Keep small parts and plastic film out of the reach of children!
FR BE NC Tenir les petites pièces et les films plastiques hors de la portée des enfants!
NL Hou de kleine onderdelen en de plastic folie uit de buurt van kinderen!
IT Tenere i componenti di piccole dimensioni e le pellicole di plastica fuori dalla portata dei bambini!
SI Malih delov in embalažne folije pri montaži pohištva hranite izven dosega otrok!
XS HR BA Mañ dijelove i foliju za pakovanje priklom montaže namještaja držite dalje od djece
HU Bitorserelés közbén a kis alkatrészek és a csomagoló fólia gyermekékhöz távol tartandók!
BG Дребни детайли и опаковъчни фолиа да се държат далеч от деца при монтажа на мебелите!
CZ SK Dřevní detaily i fólije za balení držte dále od dětí při montáži nábytku
SE Vid möbelförpackning ska smådelar och förpackningsfolien hållas oåtkomliga för barn!
RO Tineți departe de copii piesele mici și folia de ambalat la montarea mobiliei!
ES ¡Durante el montaje, mantenga alejados de los niños las piezas pequeñas y el material plástico de embalaje!

D CH AT LI LU Möbelmontage muss auf ebennem Untergrund erfolgen. Bei Wandmontagen immer geeignetes Befestigungsmaterial verwenden.
GB US Furniture must be assembled on a flat surface. For assembly to the wall only use suitable fixing materials.
FR BE NC Le meuble doit être monté sur une surface plane. Pour le montage mural, utilisez des accessoires de fixation adaptés au type de mur.
NL De meubels dienen op een vlakke ondergrond te worden gemonteerd. Voor wandmontage moeten geschikte bevestigingsmaterialen worden gebruikt.
IT Il montaggio dei mobili deve avvenire su un fondo piano. Per il montaggio si prega di utilizzare solo materiali adatti.
SI Pohištvo je treba montirati na ravni podlagi. Pri stenski montaži vedno uporabite pritrilivni material.
XS HR BA Namještaj se mora montirati na ravnoj podlozi. Kod montaže na zid uvijek koristite prikladan materijal za pričvršćivanje.
HU A bútor szerelését silk felületen kell végezni. Falra szereléshez mindig megfelelő rögzítanyagot kell használni.
BG Монтажът на мебелите да се извършва на равна основа. При стънен монтаж винаги да се използва подходящ крепежен материал.
CZ SK Montáž nábytku provádějte na rovném podkladu. Při montáži na stěnu používejte vždy vhodný příslušovací materiál.
SE Monterिंग av möbeln måste göras på jämnt underlag. Vid väggmontering ska lämpligt uppfästingsmaterial användas.
RO Montarea mobiliei trebuie să se realizeze pe o pardoseală dreaptă. La montarea la perete utilizați întotdeauna material de fixare adecvat.
ES El montaje debe efectuarse sobre una superficie uniforme. En el montaje mural emplee siempre el material de fijación adecuado.

D CH AT LI LU Bitte beachten Sie die Montageanleitung. Halten Sie immer die angegebene Wattzahl ein. Verhindern Sie einen Hitzestau.
GB US Please observe the assembly instructions. Do not exceed the max. given wattage. Ensure that the heat is not allowed to build up.
FR BE NC Veuillez respecter la notice de montage. Respectez impérativement le nombre des watts maximal. Veillez à éviter toute accumulation de chaleur.
NL Lees a.u.b. de montagehandleiding door. Hou de beslist aan het max. opgegeven wattage. Zorg ervoor dat geen hittehuwling onstaat.
IT Attenersi alle istruzioni di montaggio. Rispettarsi rigorosamente il numero di watt max. indicato. Assicurarsi che non si verifichi un accumulo di calore.
SI Upštevalje navodila za montažo. Vedno upoštevajte navedeno število vatov. Preprečite zastoj vročine.
XS HR BA Obratite pažnju! Vas pozor na uputu za montažu. Uvijek se pridržavajte navedenog broja vai. Izbjegavajte zastoj vrućine.
HU Vegye figyelembe a szerelési útmutatót. Mindig tartsa be a megadott wattszámot. Akadályozza meg a hőelődést.
BG Моля, вземете под внимание ръководството за монтаж. Спазвайте винаги посочените ватове. Избягвайте акумулиране на топлина.
CZ SK Dodržujte prosím návod k montáži. Vždy dodržujte uvedenou hodnotu výkonu (watt). Zabráňte tak přehřívání.
SE Följ monteringsanvisningen. Följ alltid angivet watttal. Undvik att hetta uppstår.
RO Respectați instrucțiunile de montaj. Respectați întotdeauna numărul de watt impus. Evitați acumularea de căldură.
ES Le rogamos que tenga presente las instrucciones de montaje. Respete siempre el número indicado de vatios. Evite la acumulación de calor.

D CH AT LI LU Halten Sie die max. zulässigen Belastungswerte der Möbelteile ein. Details siehe Montageanleitung
GB US Comply with the max. permissible loads. For details, please refer to the assembly instructions
FR BE NC Respectez les valeurs de charge max. admissibles des parties de meubles. Pour plus de détails, cf. la notice de
NL Hou de maximaal geoorloofde belastingswaarden van de meubeldelen aan. Voor details verwijzen wij naar de montagehandleiding
IT Rispettare la portata max. permessa degli elementi del mobile. Per dettagli si vedano le istruzioni di montaggio e si vada
SI Upštevalje največjo dovoljeno obremenitev delov pohištva. Podrobnosti najdete v navodilih za montažo in na
XS HR BA Tartsa be a bitorelemek max. megdoloženih opterećenja elemenata namještaja. Detalje vidj u uputu za montažu
HU Tartsa be a bitorelemek max. megengedett terhelési értékeit. A részleteket lásd a szerelési útmutatóban
BG Спазвайте макс. допустимите стойности на натоварване на мебелите. За подробности виж ръководството за монтаж
CZ SK Dodržujte max. přípustné hodnoty zatížení nábytkových dílů. Podrobnosti viz návod k montáži
SE Följ max. tillåten belastning av möbeldelarna. Mer information finns i monteringsanvisningen
RO Respectați valorile de solicitare max. admise pentru corpurile de mobilier. Pentru detalii consultați instrucțiunile de montaj
ES Respete los valores máximos de carga admisibles para las piezas de los muebles. Consulte los detalles en las instrucciones

D CH AT LI LU Zur Möbelfreinigung ein mit Wasser befeuchtetes, fusselfreies Baumwolltuch verwenden. Geeignigte Flächen immer trockenreiben!
GB US To clean the furniture only use a water dampened lint-free cotton cloth. Once cleaned, always wipe the surfaces dry.
FR BE NC Utilisez un chiffon en coton non pelucheux humidifié avec de l'eau pour nettoyer les meubles. Séchez systématiquement les surfaces
NL nettooyes en les froltant!
IT Gebrüik een met water bevochtigde, pluusvrije katoenen doek om de meubels te reinigen. Wrijf gereinigde oppervlakken altijd droog!
SI Per pulire il mobile utilizzare un panno di cotone inumidito d'acqua e che non perde pelucchi. Asciugare sempre le superfici che si sono pulite!
XS HR BA Za čišćenje pohištva uporabljajte vlažno bombažno krpo, ki ne pušča vlaken. Očiščene površine vedno obrišite do suhlega!
HU Za čišćenje namještaja koristite sa vodom navlaženu pamučnu krpu koja ne ispušta vlakna. Očišćene površine uvijek obrišite suhom krpom!
BG За почистване на мебелите използвайте навлажнена с вода, неизглусяща влакна памучна кърпа. Почистените повърхности винаги да се изтриват до сухо!
CZ SK K čištění nábytku používejte bavlněný hadr neuvloňující vlákna, navlhčený ve vodě. Učištěné plochy vždy utřete do sucha!
SE För möbelförpackning används en luddfri bomullsduk fuktad med vatten. Rengjorda ytor ska alltid torflas torra!
RO Pentru curățarea mobiliei utilizați o lavetă din bumbac fără scame umezită cu apă. Suprafețele curățate se șterg întotdeauna până se usucă!
ES Emplee un paño de algodón humedecido con agua y libre de pelusa para la limpieza de los muebles. ¡Seque siempre las superficies que ha limpiado!