

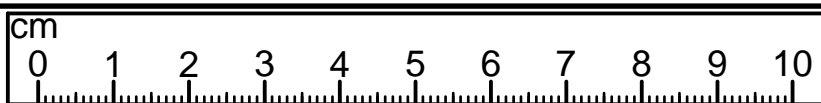

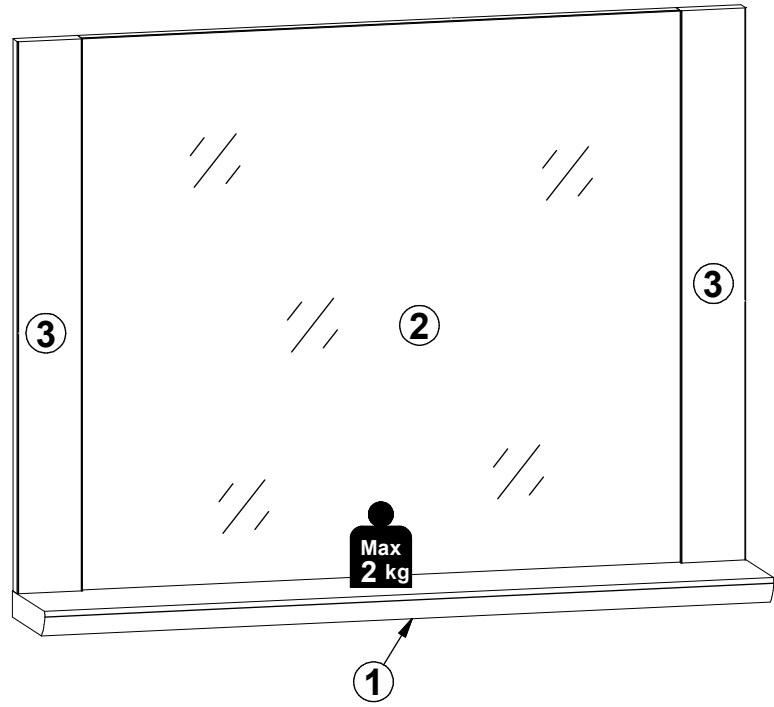

Ø10mm

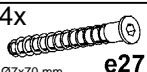
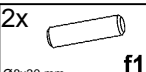
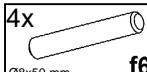

A	B	C (mm)		D
1	M222-3002	900	150	1/1
2	M222-4502	668,	739	1/1
3	M222-5001	668,	80	1/1

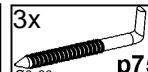
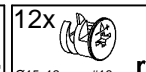
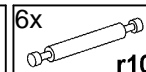
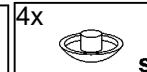

- 4x  e27  
Ø7x70 mm
- 2x  f1  
Ø8x30 mm
- 4x  f6  
Ø8x50 mm
- 3x  f35  
Ø10x50 mm
- 3x  p75  
Ø6x60 mm
- 12x  r1  
Ø15x12 mm #16
- 6x  r10  
Ø6x60 mm
- 4x  s1
- 1x  z1

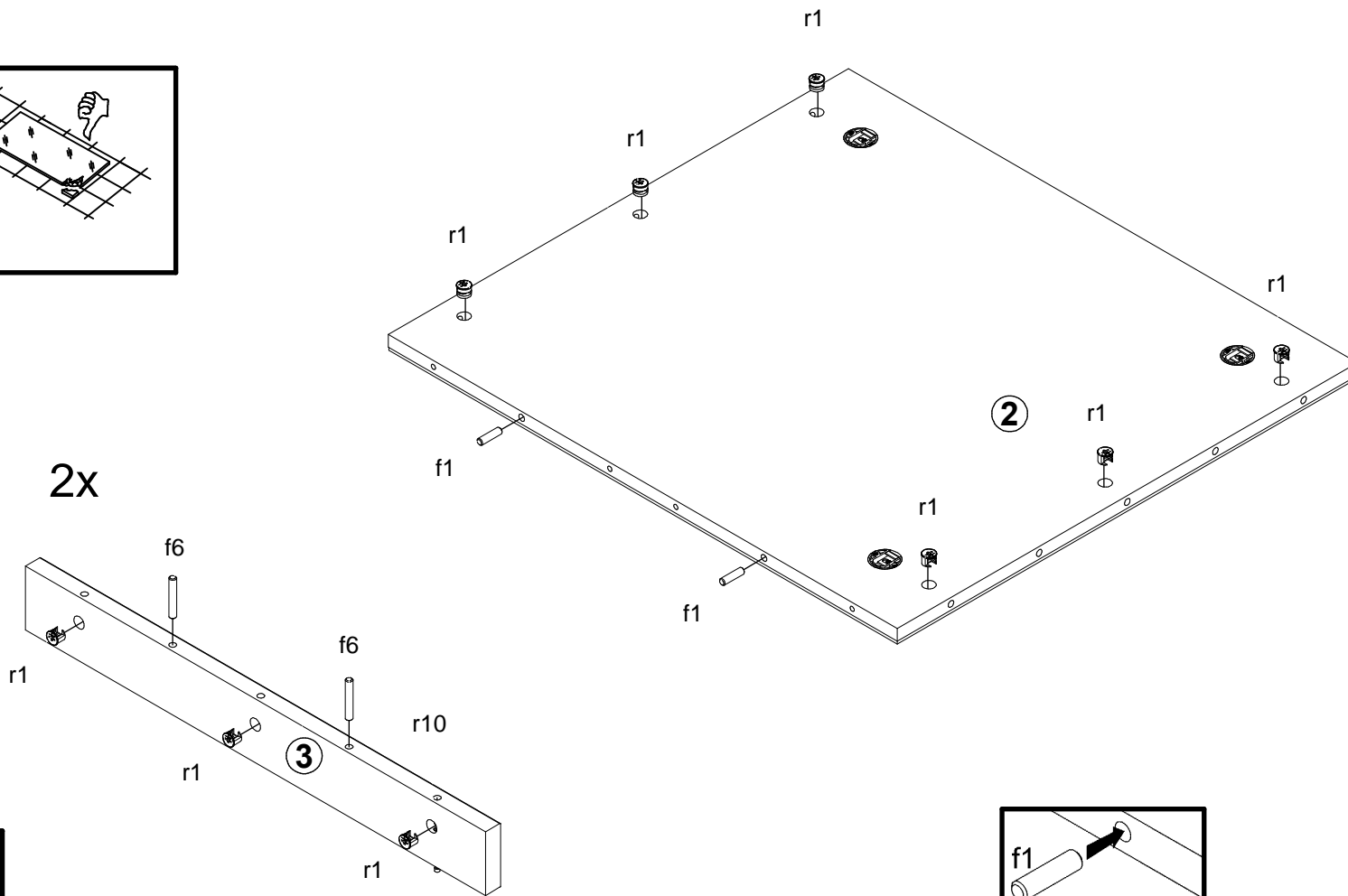
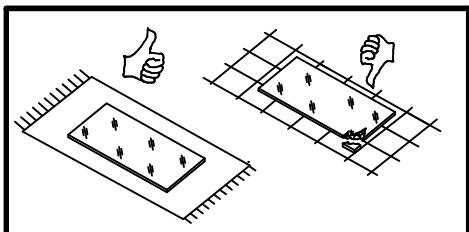
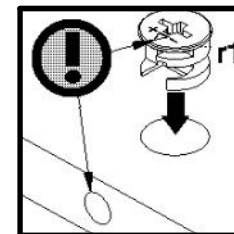

2x

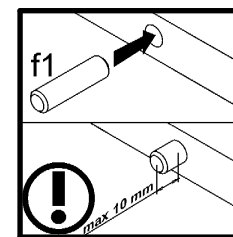
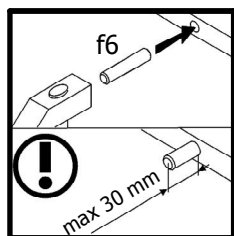

- 2x f1
- 4x f6
- 9x r1

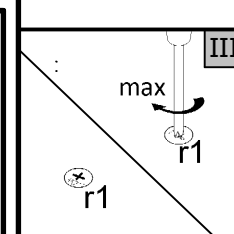
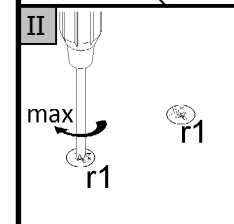
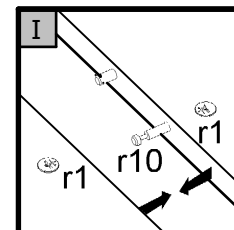
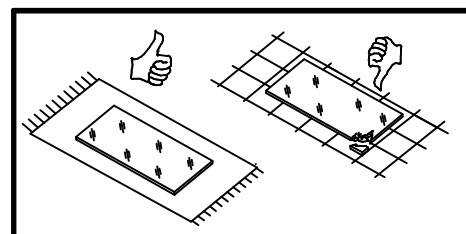
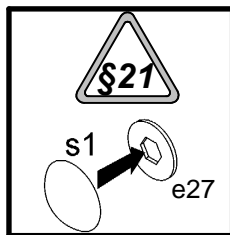
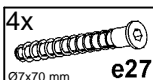
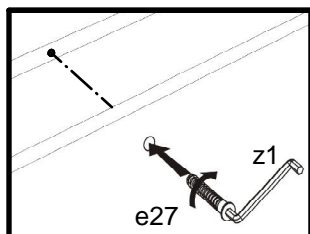
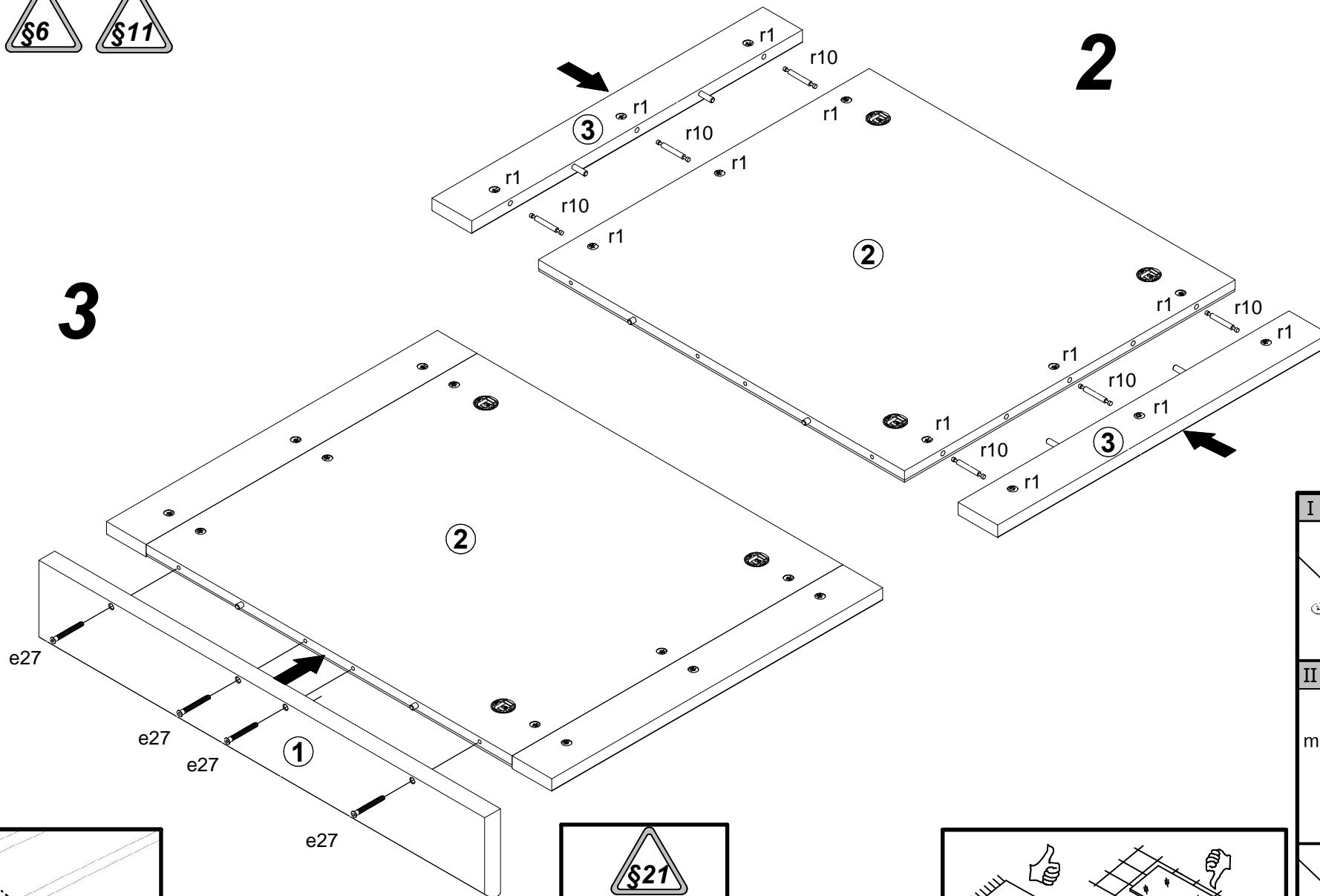
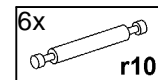

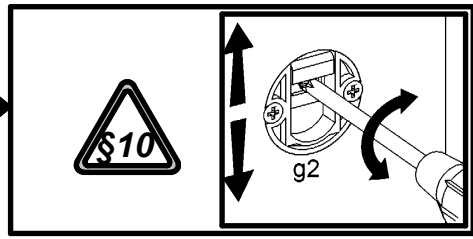
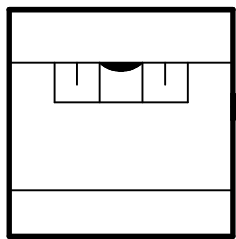

5

