

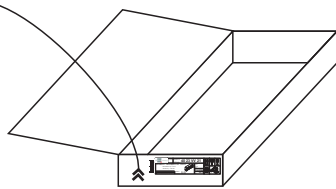

B - 820mm  
H - 2025mm  
T - 374mm

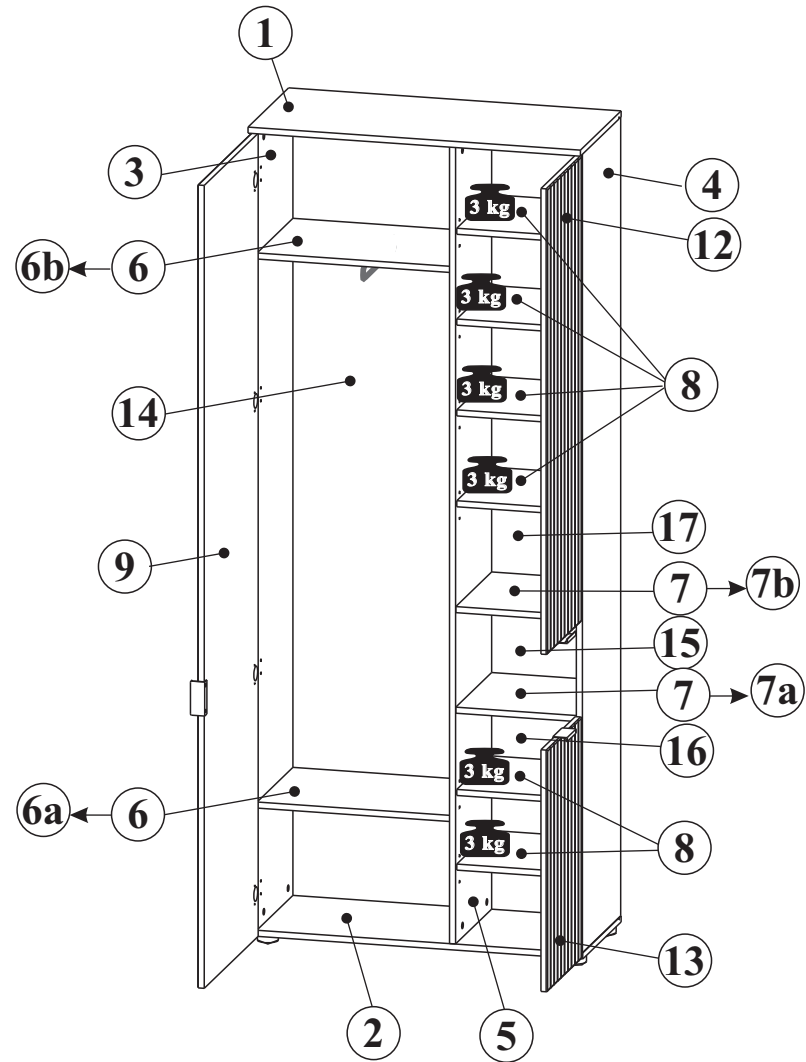



1	820	374	1	3/3
2	820	353	1	3/3
3	1970	352	1	2/3
4	1970	352	1	2/3
5	1970	332	1	2/3
6	475	330	2	1/3
7	298	330	2	1/3
8	298	320	6	1/3
9	1980	496	1	3/3
12	1148	316	1	1/3
13	596	316	1	1/3
14	1979	487	1	3/3
15	237	310	1	3/3
16	581	310	1	1/3
17	1150	310	1	1/3

**NR 1**

**B1**   $\phi$  8x28 x28

**M1**   $\phi$  15x12mm x28

**T1**  5x39mm x28

**W1**  x24

**J23**  x22

**P2**  3x20 x14

**F1**  x10

**C14**   $\phi$  20mm x24

**vito**  x1

**NR 2**

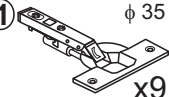
**X11**   $\phi$  35 x9

Kr0

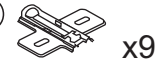
**PC**  H0 x9

**E3**  6,3x13 x18

**S8**  4x13 x18

**NR 3**

**F10**  x5

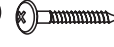
**P4**  4x25 x5

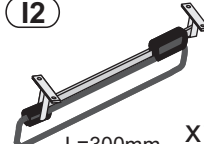
**I2**  L=300mm x1

**P13**  3,5x13 x4

**NR 4**

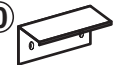
**U180**  x3

**S3A**  3,5x13 x6

**NR 5**

**J11**  x1

**P13**  3,5x13 x2

**T13**  8x50 mm x1

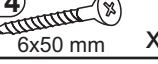
**T14**  6x50 mm x1

**NR 6**

**SQ 2S**  x1

**O21**  MAX 1,2 W x1

**C40**  x1

C 1/3

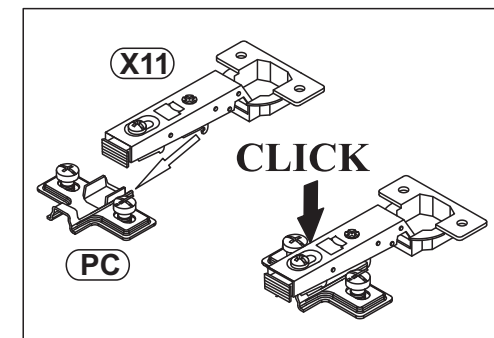
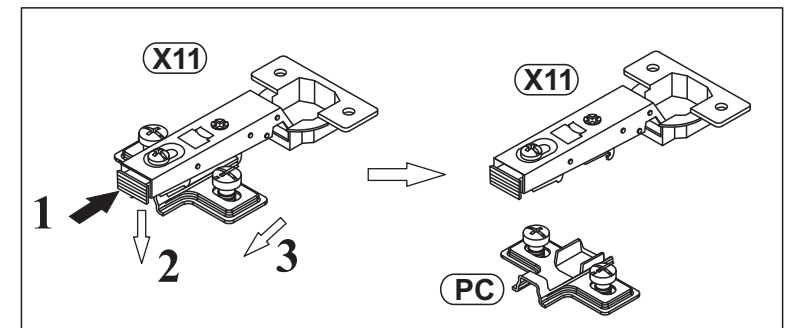

# 1

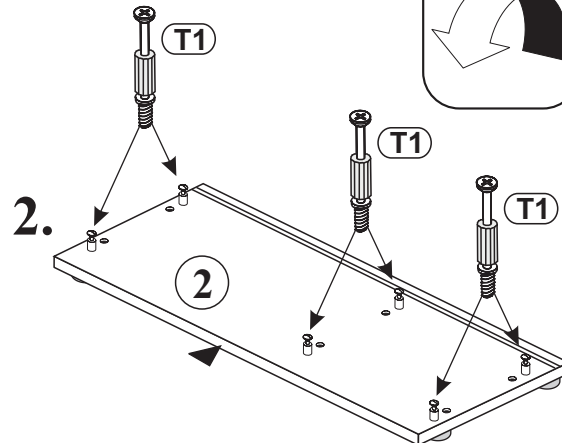
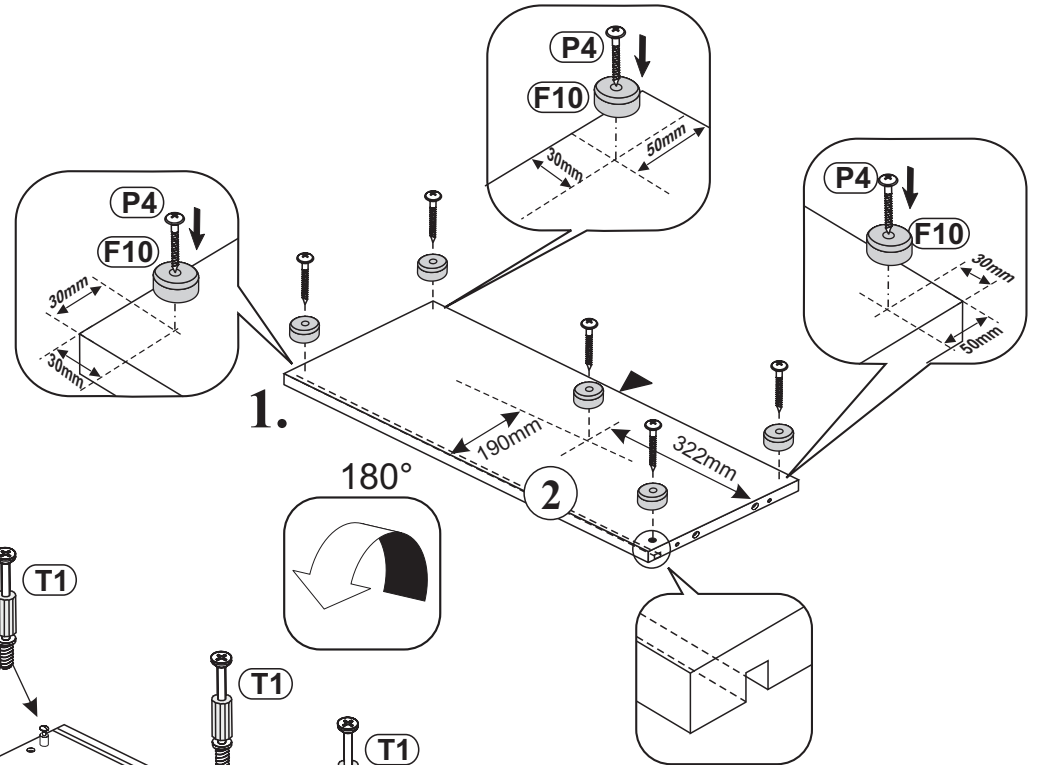
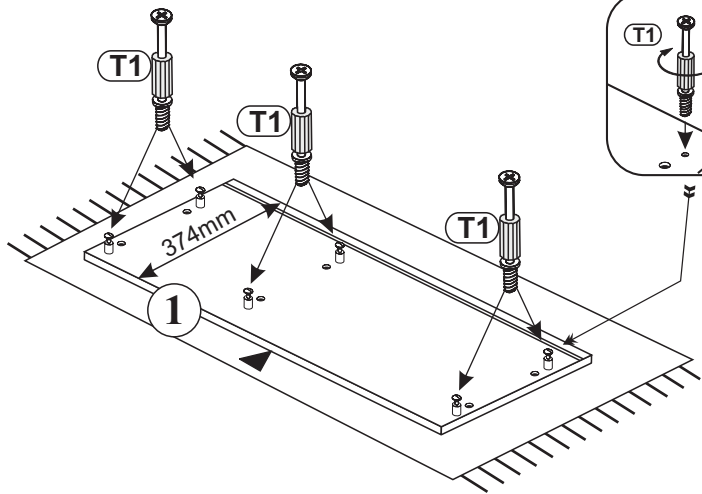
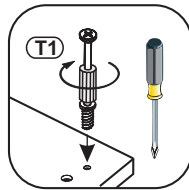
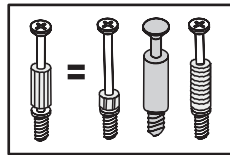
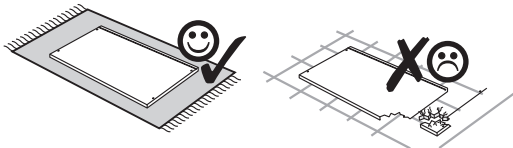
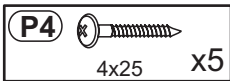
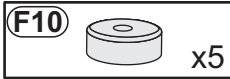
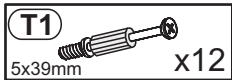

## 2

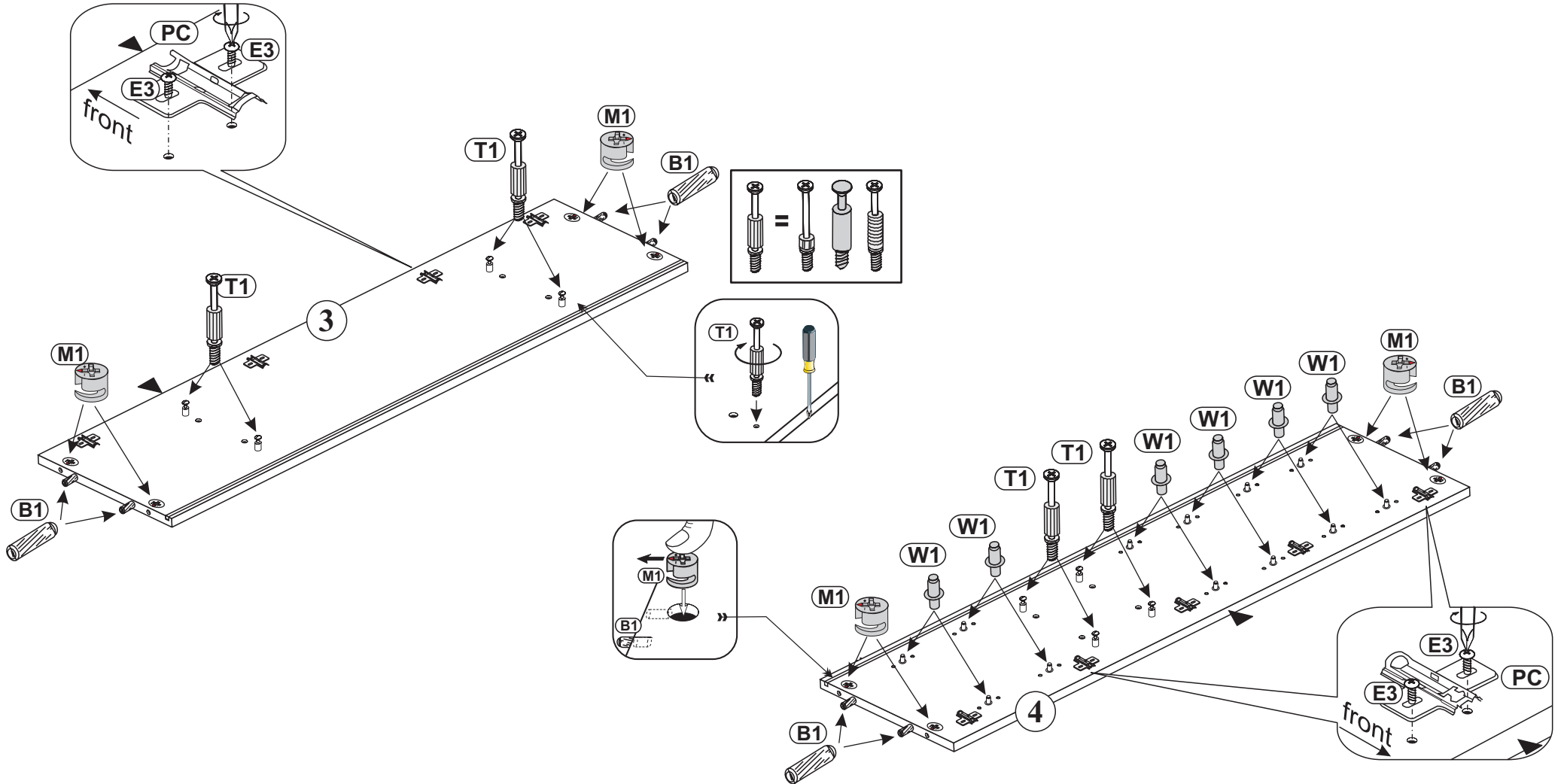
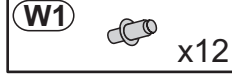
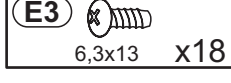
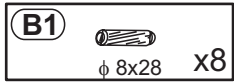
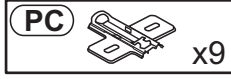

### 3

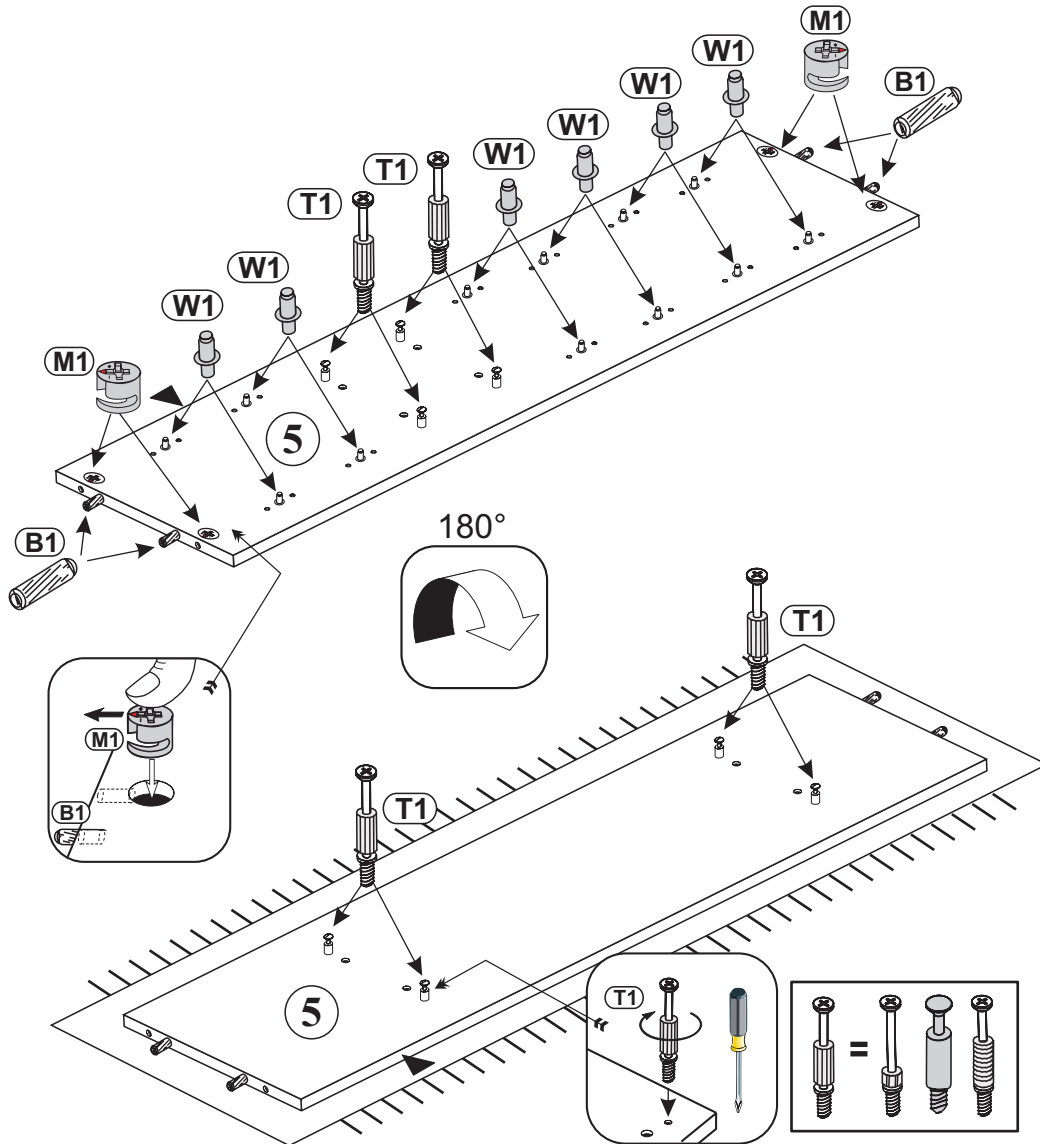
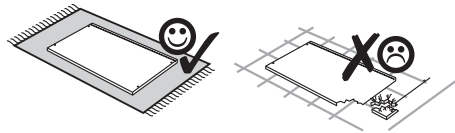
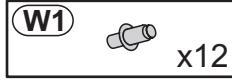
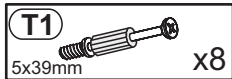

### 4

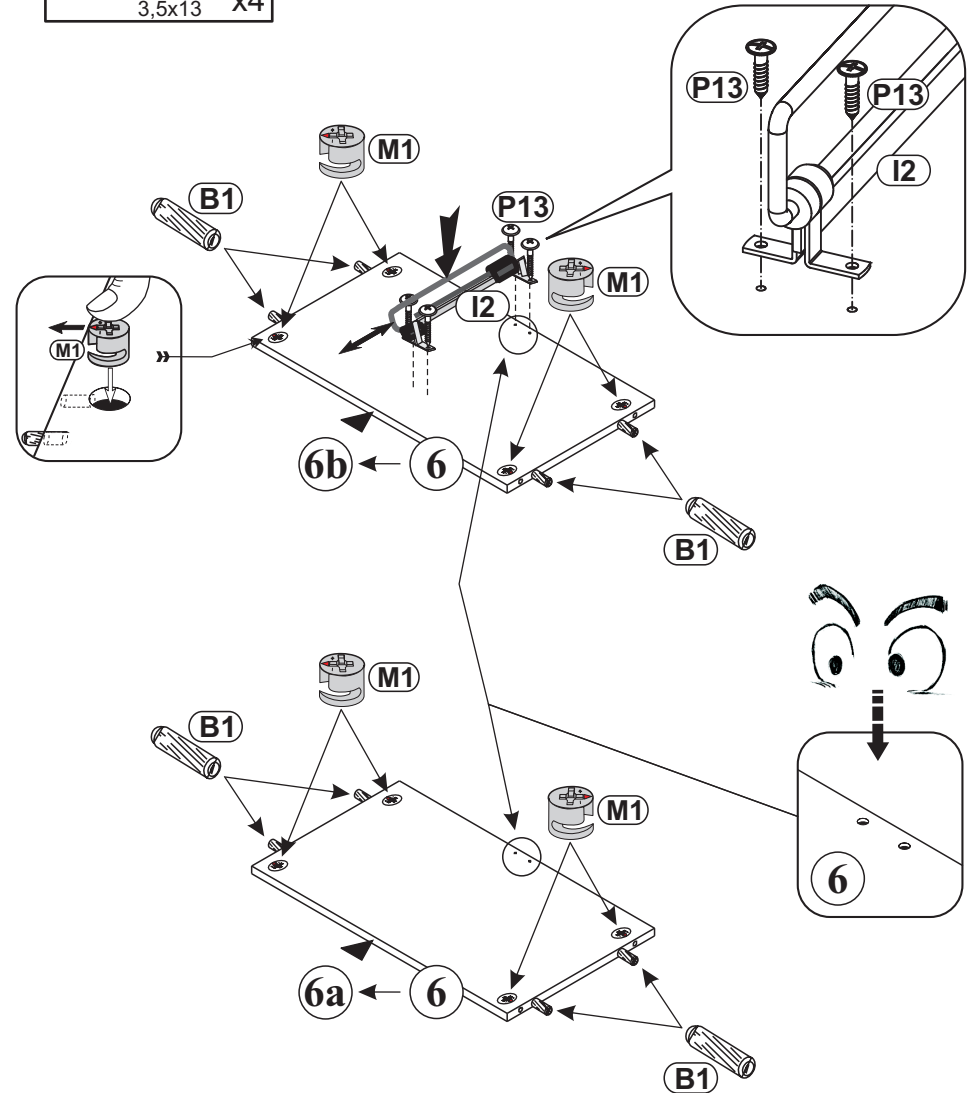
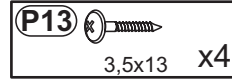
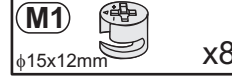
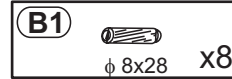
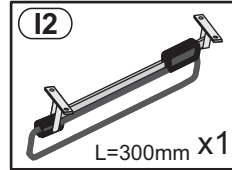

## 5

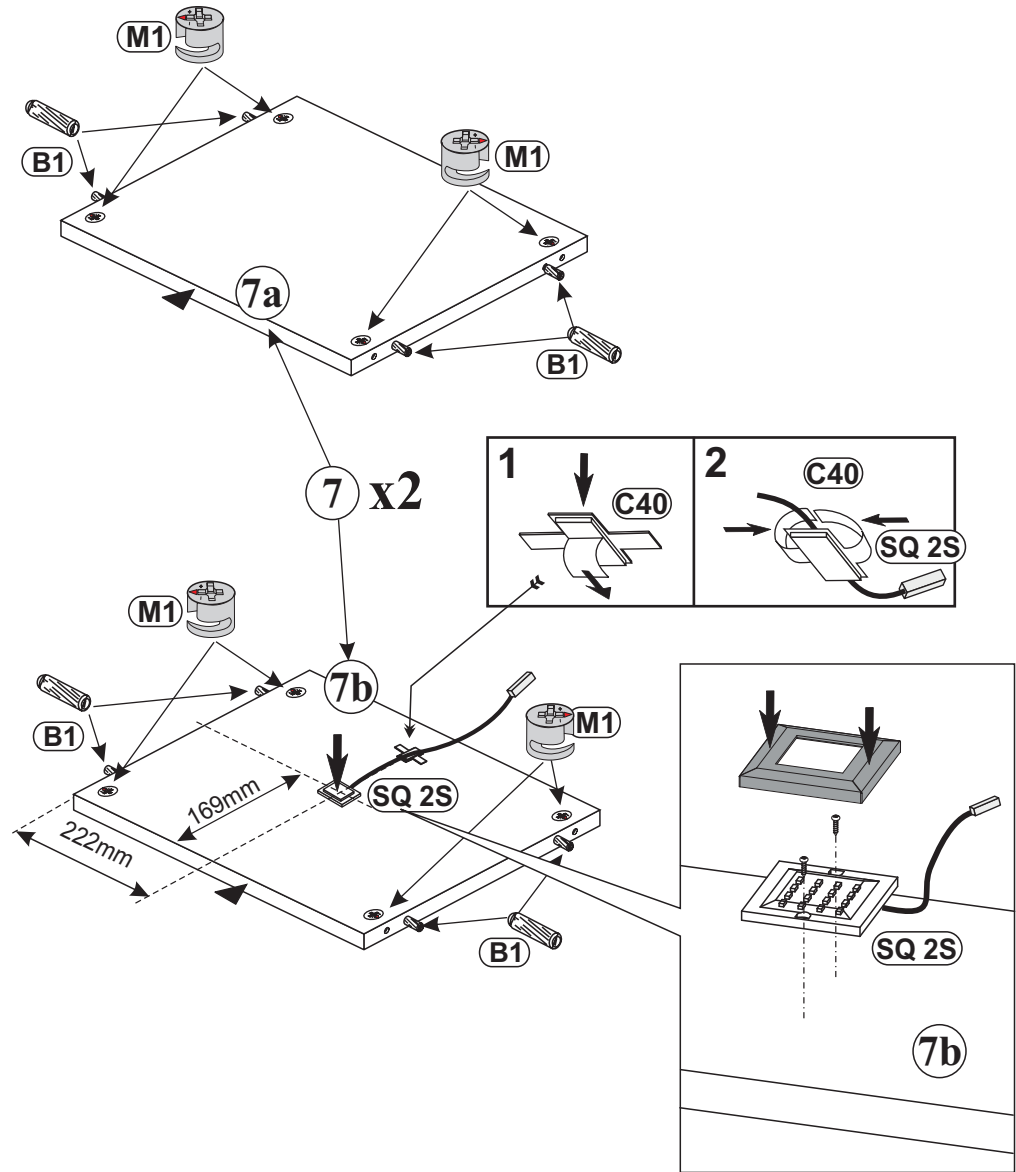
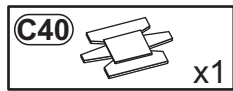
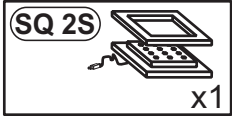
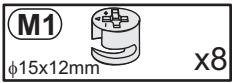

## 6

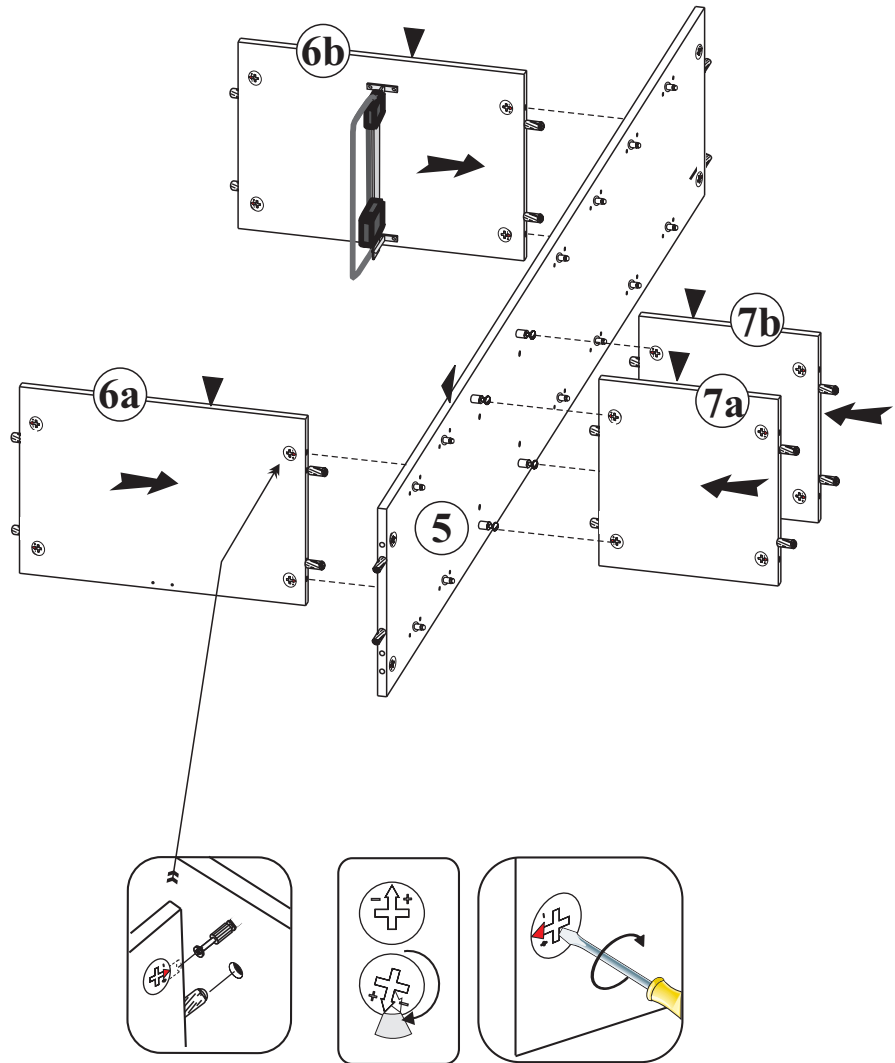

7

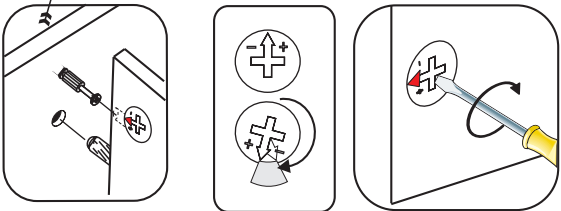
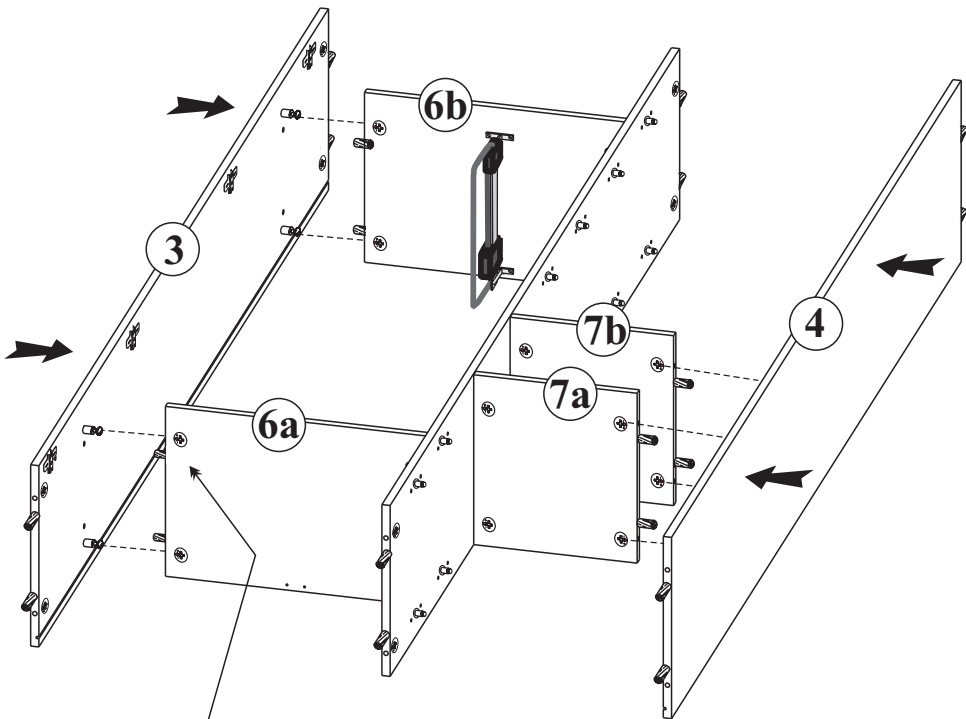

8

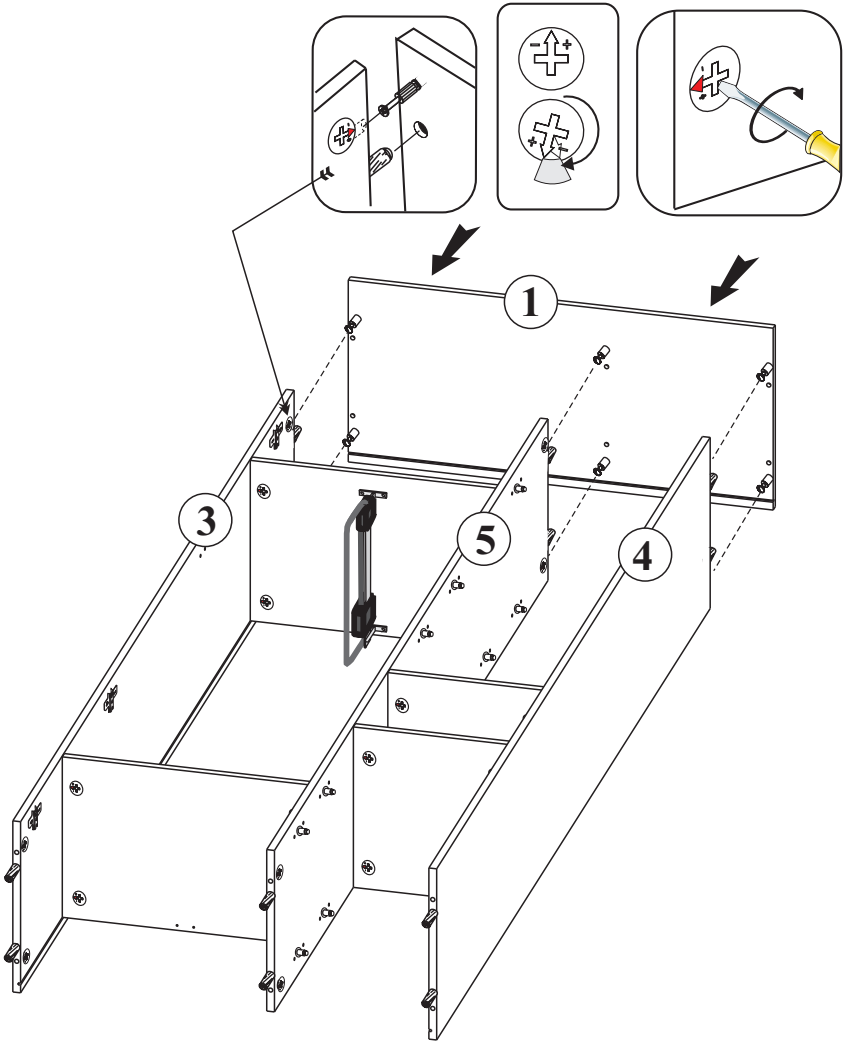



9

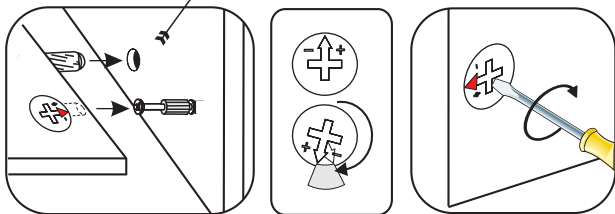
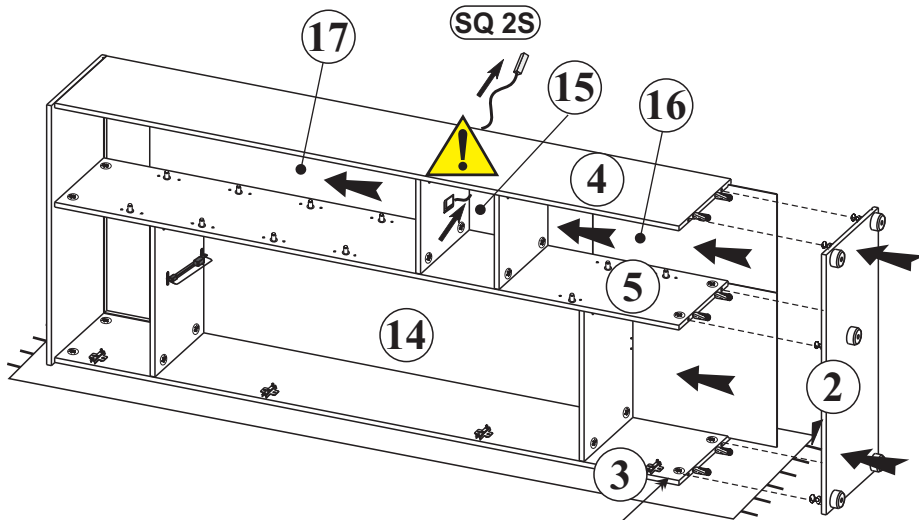
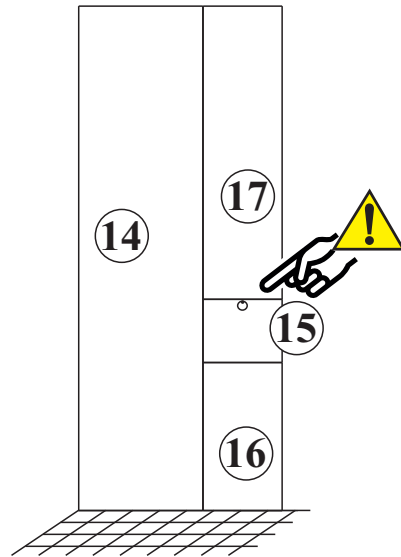
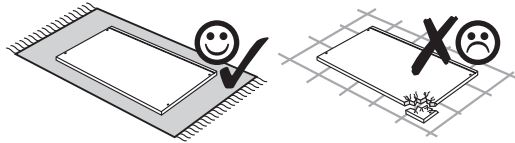

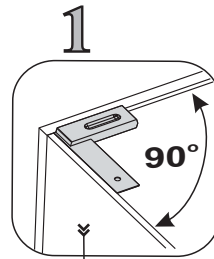

10

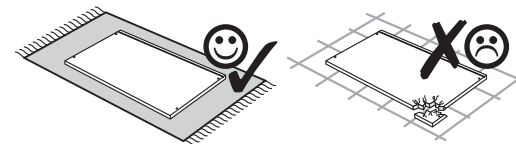
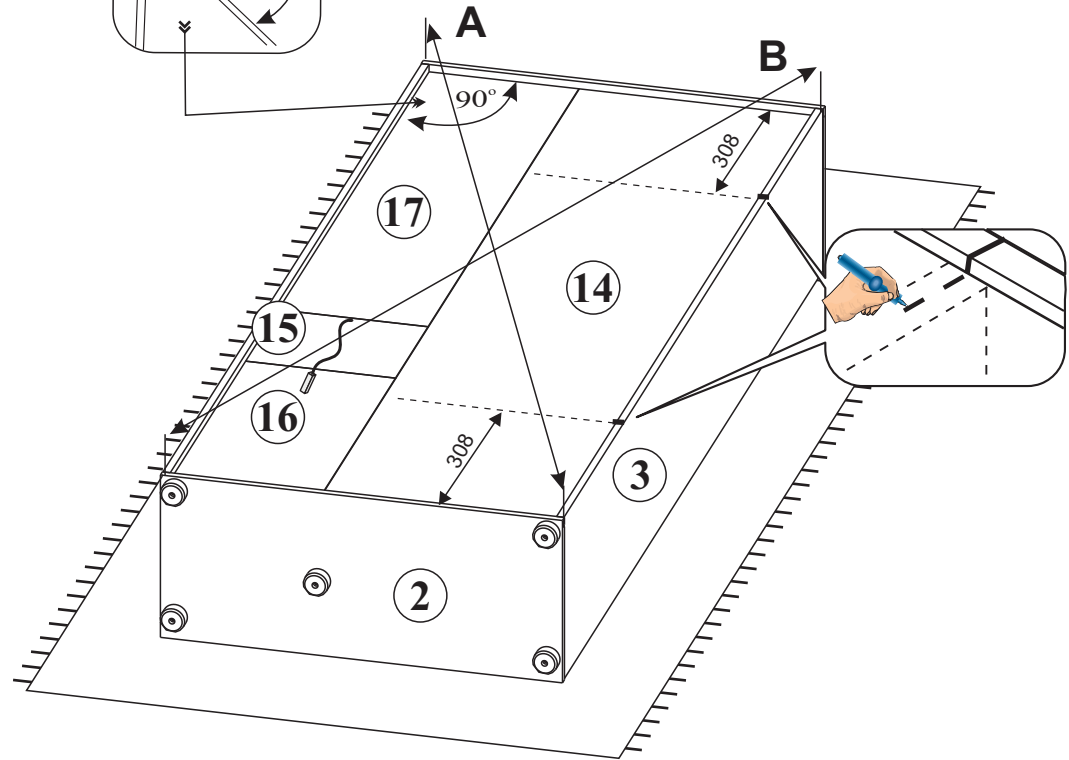

A=B ☺ ✓





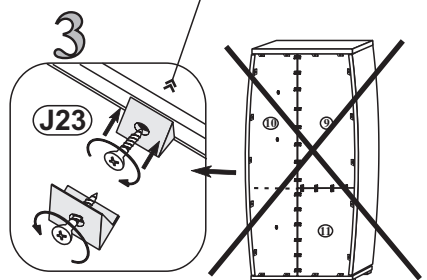
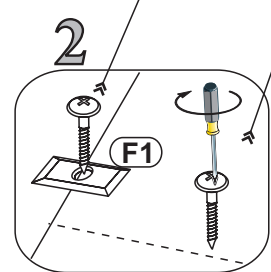
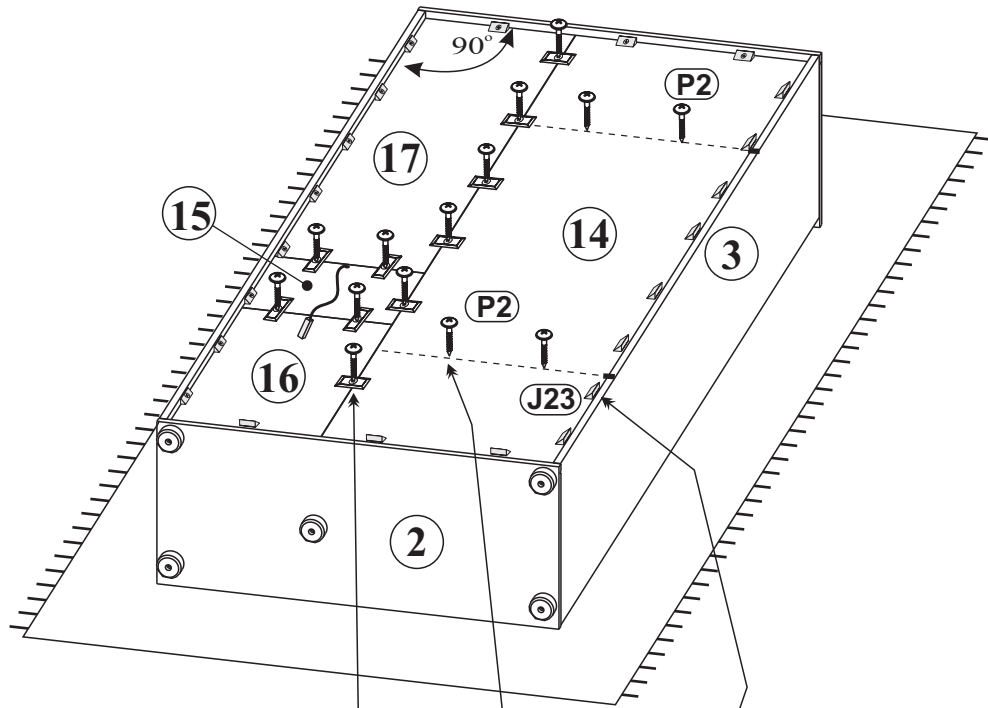
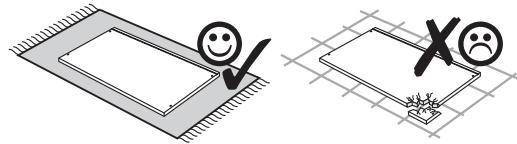

## 11

- J23**  x22
- P2**  3x20 x14
- F1**  x10



## 12

- T14**  6x50 mm x1
- T13**  8x50 mm x1
- P13**  3,5x13 x2
- J11**  x1

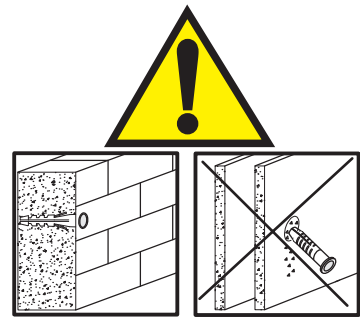
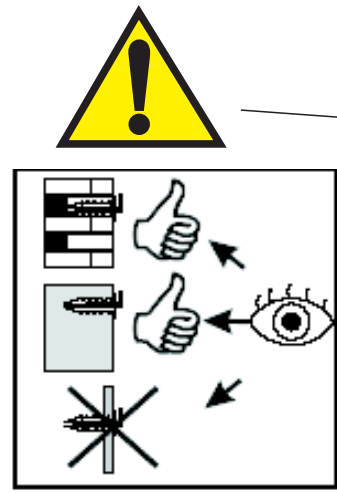
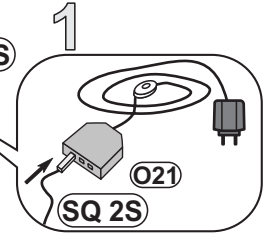
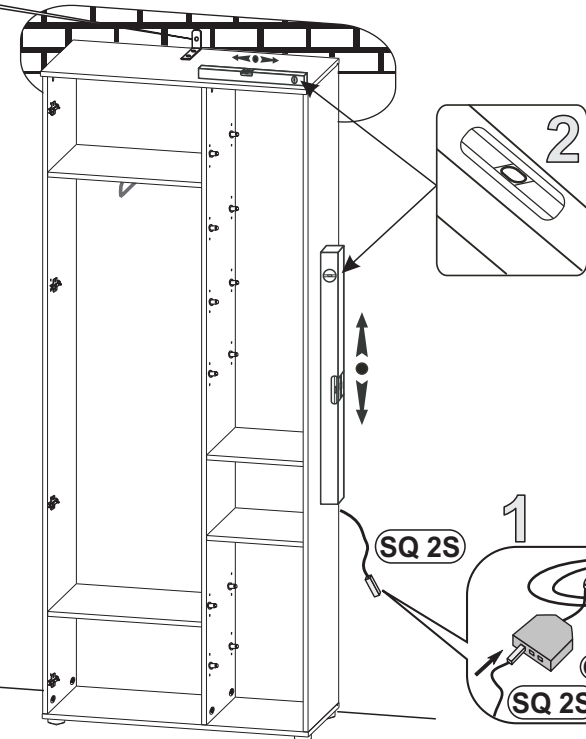
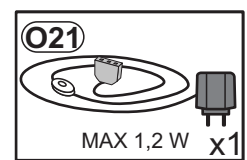
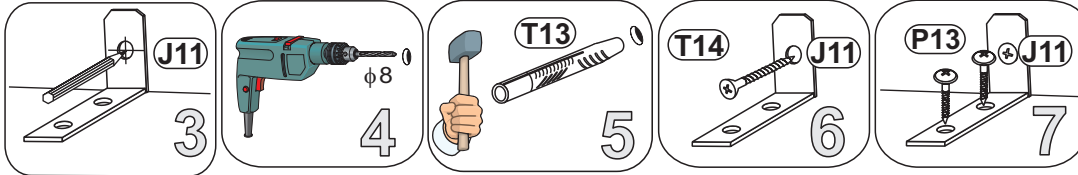

13

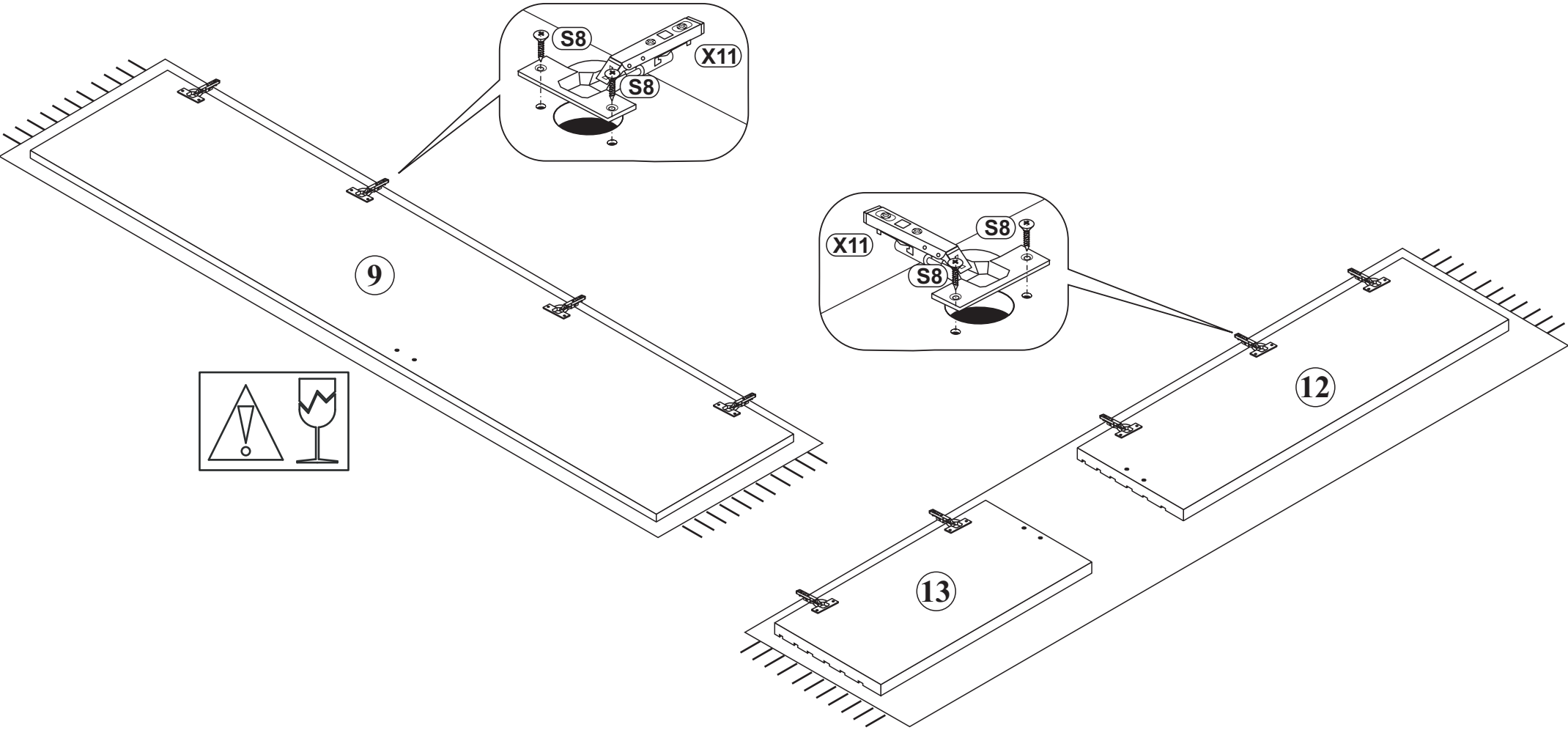
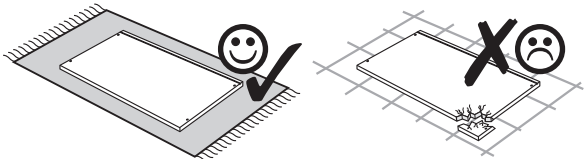
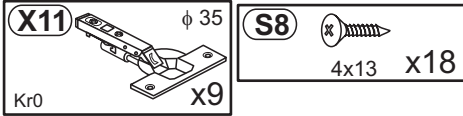

14

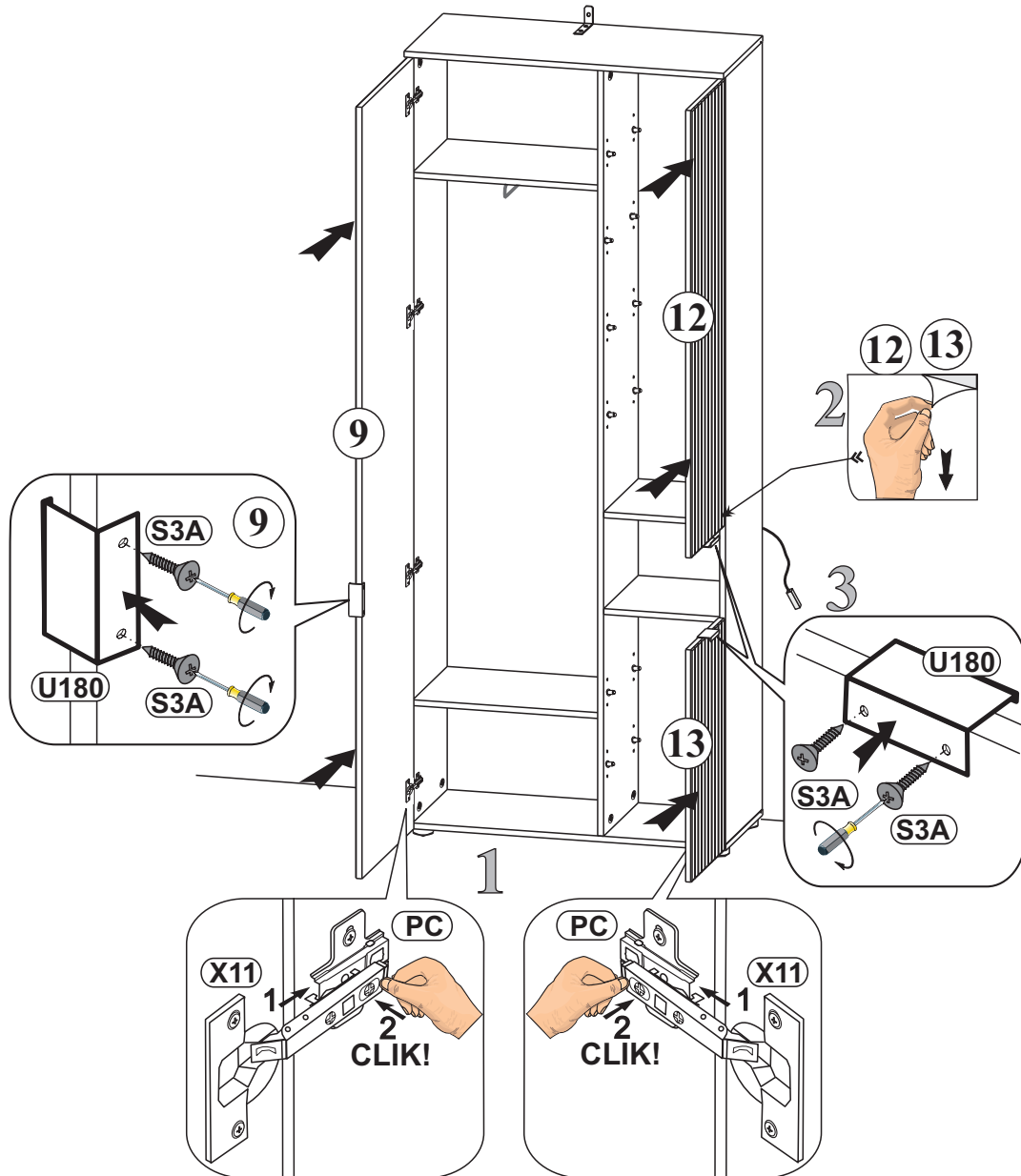
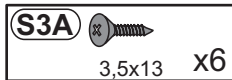

15

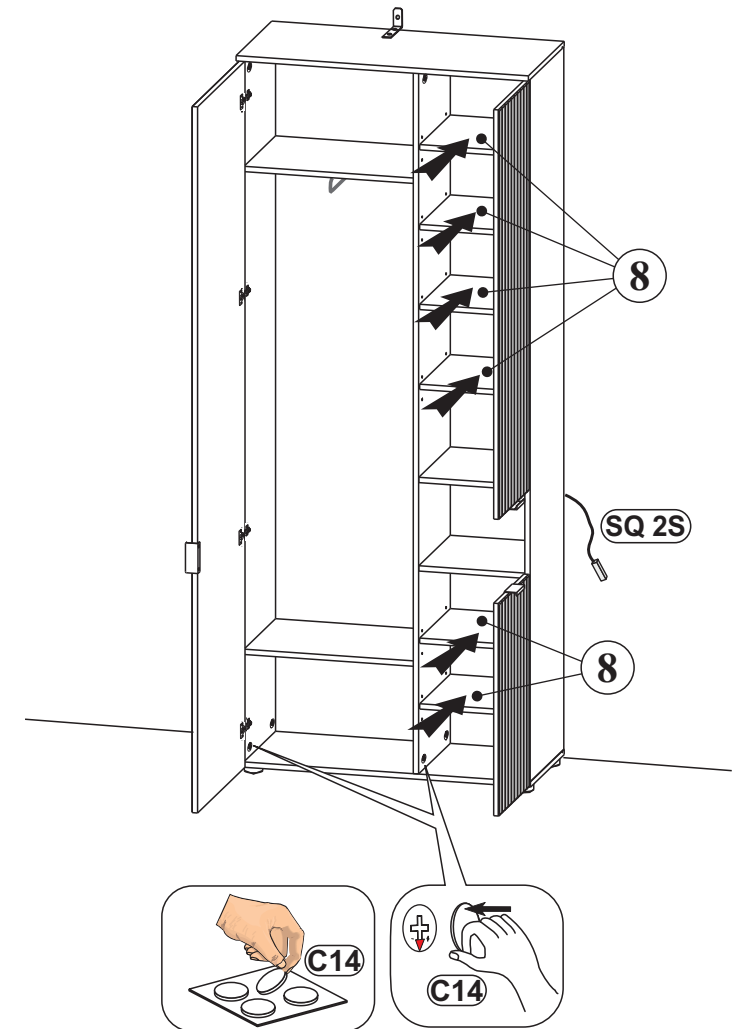
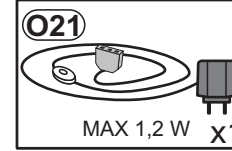
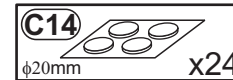

16

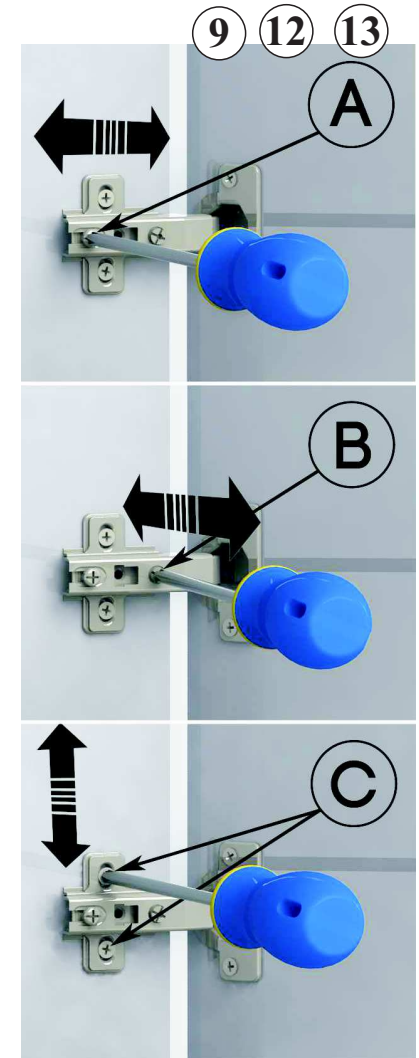
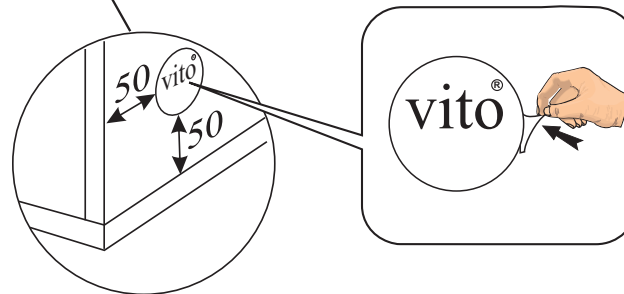
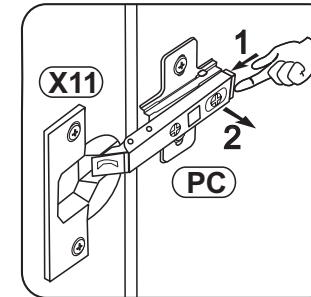
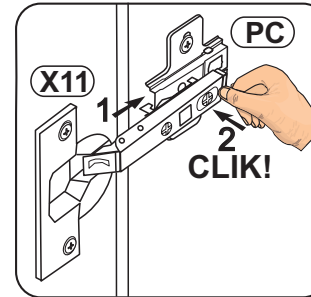
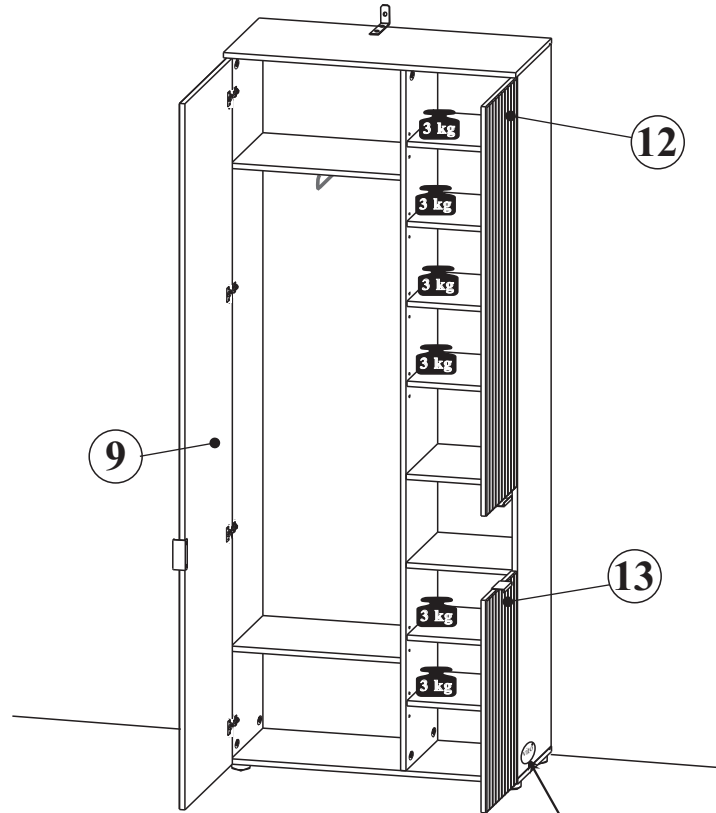

82

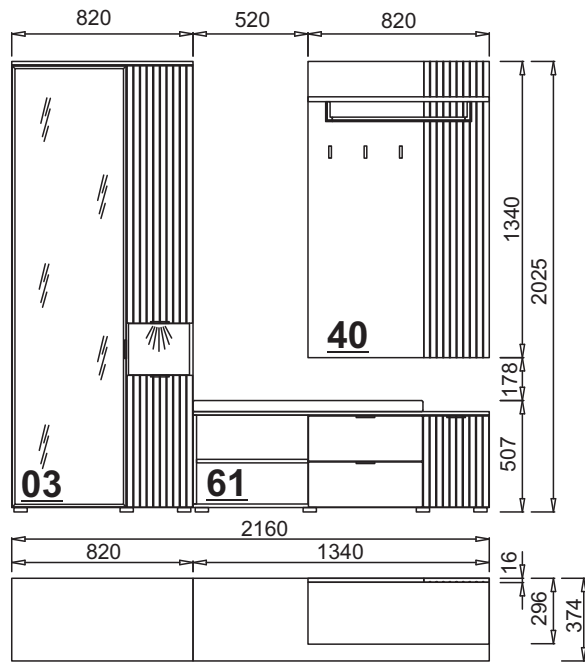



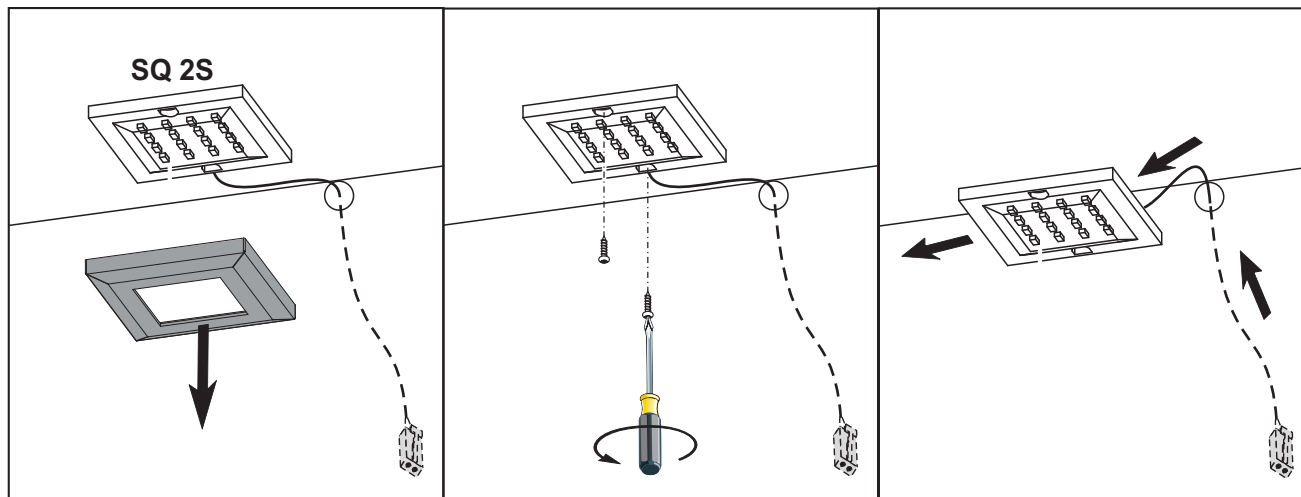

787846 SQUERE2S-PCB-NW

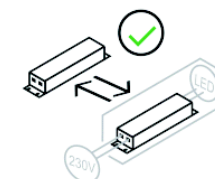
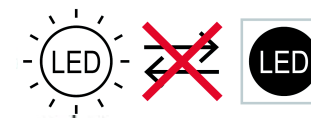

**PL-** Ten produkt zawiera źródła światła o klasie efektywności energetycznej „F”

**DE-** Diese Produkte enthalten Lichtquellen der Energieeffizienzklasse „F”

**CS-** Tento výrobek obsahuje světelný zdroj třídy energetické účinnosti „F”

**DA-** Dette produkt indeholder en lyskilde til energieffektivitetsklasse „F”

**EL-** Αυτό το προϊόν περιέχει μια πηγή φωτεινής πηγής ενεργειακής απόδοσης „F”

**EN-** This product contains a light sources of energy efficiency class „F”

**ES-** Este producto contiene una fuente de luz de clase de eficiencia energética „F”

**ET-** See toode sisaldab efektiivsusklassi valgusallikat energia "F”

**FI-** Tämä tuote sisältää energiatehokkuusluokan valonlähteen „F”

**FR-** Ce produit contient des sources lumineuses de classe d'efficacité „F”

**HU-** Ez a termék energiahatékonysági osztályú fényforrást tartalmaz „F”

**IT-** Questo prodotto contiene una sorgente luminosa di classe di efficienza energetica „F”

**LT-** Šiame gaminyje yra energijos vartojimo efektyvumo klasės šviesos šaltinis „F”

**LV-** Šis produkts satur gaismas avotu ar energoefektivitātes klasi „F”

**RU-** Этот продукт содержит источник света класса энергоэффективности „F”

**PT-** Este produto contém uma fonte de luz da classe de eficiência energética „F”

**RO-** Acest produs conține o sursă de lumină de clasă de eficiență energetică „F”

**NL-** Dit product bevat een lichtbron met energie-efficiëntieklasse „F”

**SK-** Tento výrobek obsahuje svetelný zdroj triedy energetickej účinnosti „F”

**SLO-** Ta izdelek vsebuje svetlobni vir razreda energijske učinkovitosti „F”

**SV-** Denna produkt innehåller en ljuskälla för energieffektivitetsklass „F”

**TR-** Bu ürün bir ışık kaynağı enerji verimliliği sınıfı içerir „F”

**HR-** Ovaj proizvod sadrži izvor svjetlosti razreda energetske učinkovitosti „F”

**BG-** Този продукт съдържа източник на светлина от клас на енергийна ефективност „F”

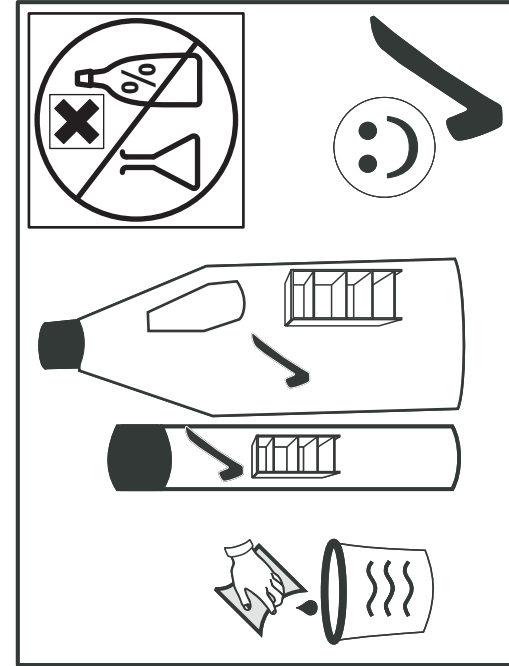
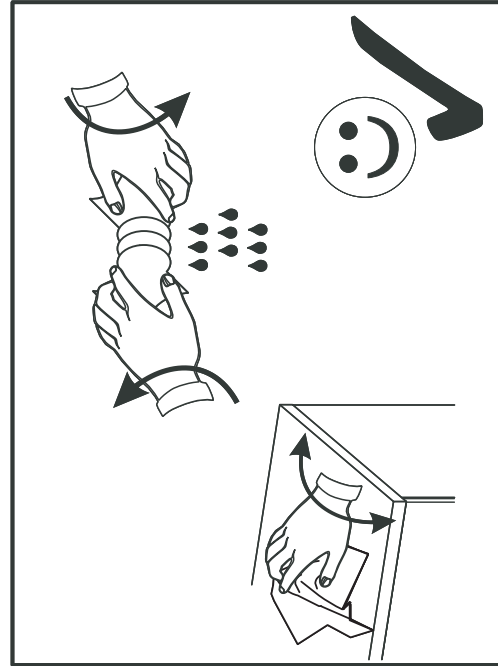
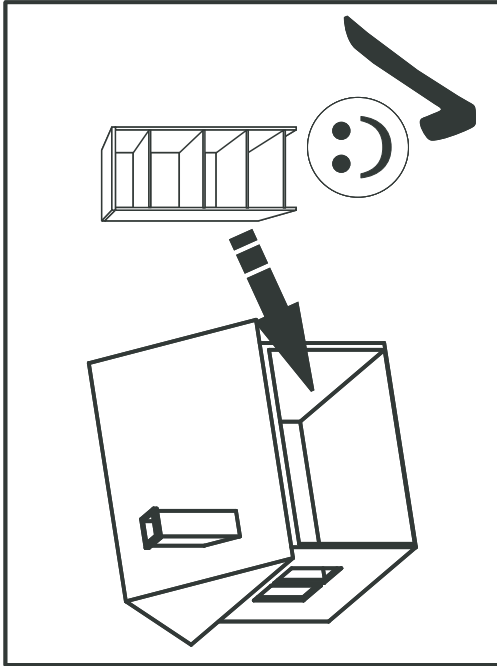
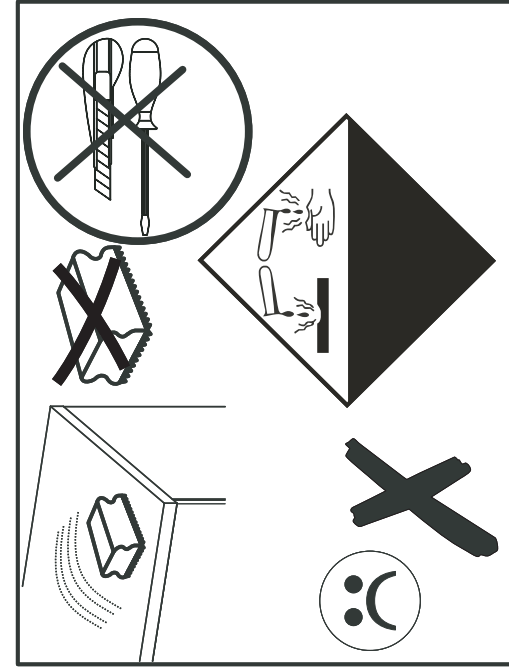
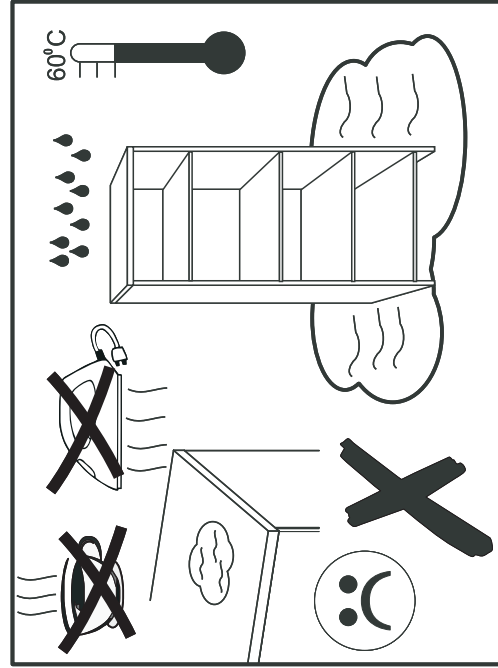
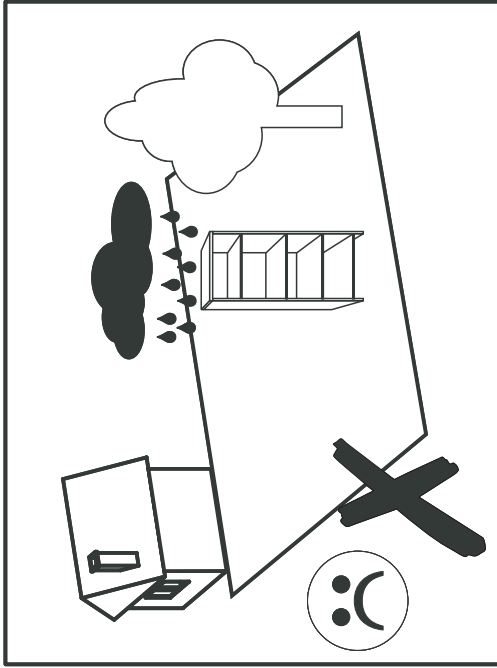
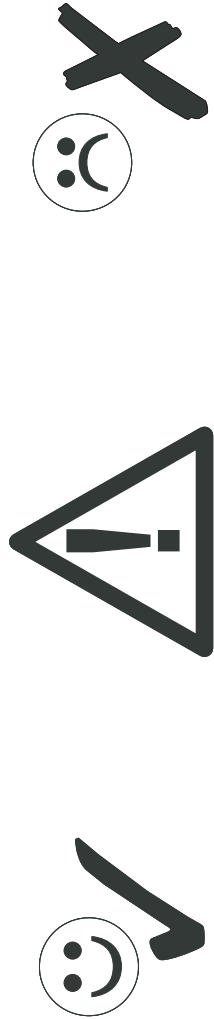



**D CH AT LI LU** Kleinstele und Verpackungsfolien bei der Möbelmontage von Kindern fernhalten!  
**GB US** Keep small parts and plastic film out of the reach of children!  
**FR BE NC** Tenir les petites pièces et les films plastiques hors de la portée des enfants!  
**NL** Hou de kleine onderdelen en de plastic folie uit de buurt van kinderen!  
**IT** Tenere i componenti di piccole dimensioni e le pellicole di plastica fuori dalla portata dei bambini!  
**SI** Malhni delov i foliju za pakovanje priklom montaži pohištna priane izven dosega otrok!  
**XS HR BA** Mahe dijelove i foliju za pakovanje priklom montaže namještaja držite dalje od djece  
**HU** Bútorészeket közbden a kis alkatrészek és a csomagoló fóliák gyerekekkel távol tartandók!  
**BG** Дребни детайли и опаковъчни фолия да се държат далеч от деца при монтажа на мебелите!  
**CZ SK** Vidí montáži nábytku uchovávejte drobné díly a obalové fólie z dosahu dětí!  
**SE** Vidí möbelföringen ska smådelar och förpackningsfolien hållas oåtkomliga för barn!  
**RO** Țineți departe de copil piesele mici și folia de ambalat la montarea mobiliei!  
**ES** ¡Durante el montaje, mantenga alejados de los niños las piezas pequeñas y el material plástico de embalaje!

**D CH AT LI LU** Möbelmontage muss auf ebennem Untergrund erfolgen. Bei Wandmontagen immer geeignetes Befestigungsmaterial verwenden.  
**GB US** Furniture must be assembled on a flat surface. For assembly to the wall only use suitable fixing materials.  
**FR BE NC** Le meuble doit être monté sur une surface plane. Pour le montage mural, utilisez des accessoires de fixation adaptés au type de mur.  
**NL** De meubels dienen op een vlakke ondergrond te worden gemonteerd. Voor wandmontage moeten geschikte bevestigingsmaterialen worden gebruikt.  
**IT** Il montaggio dei mobili deve avvenire su un fondo piano. Per il montaggio si prega di utilizzare solo materiali adatti.  
**SI** Pohištvo je treba montirati na ravni podlagi. Pri stenski montaži vedno uporabite pritrilveni material.  
**XS HR BA** Namještaj se mora montirati na ravnoj podlozi. Kod montaže na zid uvijek koristite prikladan materijal za pričvršćivanje.  
**HU** A bútorcszerelési silk felületen kell végezni. Falra szereléshez mindig megfelelő rögzítianyagot kell használni.  
**BG** Монтажът на мебелите да се извършва на равна основа. При стенен монтаж винаги да се използва подходящ крепежен материал.  
**CZ SK** Montáž nábytku provádějte na rovném podkladu. Při montáži na stěnu používejte vždy vhodný příslušenací materiál.  
**SE** Monteringen av möbelen måste göras på jämnt underlag. Vid väggmontering ska lämpligt uppfästingsmaterial användas.  
**RO** Montarea mobiliei trebuie să se realizeze pe o pardoseală dreaptă. La montarea la perete utilizați întotdeauna material de fixare adecvat.  
**ES** El montaje debe efectuarse sobre una superficie uniforme. En el montaje mural emplee siempre el material de fijación adecuado.

**D CH AT LI LU** Bitte beachten Sie die Montageanleitung. Halten Sie immer die angegebene Wattzahl ein. Verhindern Sie einen Hitzestau.  
**GB US** Please observe the assembly instructions. Do not exceed the max. given wattage. Ensure that the heat is not allowed to build up.  
**FR BE NC** Veuillez respecter la notice de montage. Respectez impérativement le nombre des watts maximal. Veillez à éviter toute accumulation de chaleur.  
**NL** Lees a.u.b. de montagehandleiding door. Hou de beslist aan het max. opgegeven wattage. Zorg ervoor dat geen hittehuwling onstaat.  
**IT** Attenersi alle istruzioni di montaggio. Rispettarsi rigorosamente il numero di watt max. indicato. Assicurarsi che non si verifichi un accumolo di calore.  
**SI** Upoštevajte navodila za montažo. Vedno upoštevajte navedeno število vatov. Preprečite zastoj vročine.  
**XS HR BA** Obratite pažnju! Vas pozor na uputu za montažu. Uvijek se pridržavajte navedenog broja vati. Izbjegavajte zastoj vrućine.  
**HU** Vegye figyelembe a szerelési útmutatót. Mindig tartsa be a megadott wattszámot. Akadályozza meg a hőelődést.  
**BG** Моля, вземете под внимание ръководството за монтаж. Спазвайте винаги посочените ватове. Избягвайте акумулиране на топлина.  
**CZ SK** Dodržujte prosím návod k montáži. Vždy dodržujte uvedenou hodnotu výkonu (watt). Zabráňte tak přehřívání.  
**SE** Följ monteringsanvisningen. Följ alltid angivet watttal. Undvik att hetta uppstår.  
**RO** Respectați instrucțiunile de montaj. Respectați întotdeauna numărul de watt impus. Evitați acumularea de căldură.  
**ES** Le rogamos que tenga presente las instrucciones de montaje. Respete siempre el número indicado de vatios. Evite la acumulación de calor.

**D CH AT LI LU** Halten Sie die max. zulässigen Belastungswerte der Möbelteile ein. Details siehe Montageanleitung  
**GB US** Comply with the max. permissible loads. For details, please refer to the assembly instructions  
**FR BE NC** Respectez les valeurs de charge max. admissibles des parties de meubles. Pour plus de détails, cf. la notice de  
**NL** Hou de maximaal geoorloofde belastingswaarden van de meubeldelen aan. Voor details verwijzen wij naar de montagehandleiding  
**IT** Rispettare la portata max. permessa degli elementi del mobile. Per dettagli si vedano le istruzioni di montaggio e si vada  
**SI** Upoštevajte največjo dovoljeno obremenitev delov pohištna. Podrobnosti najdete v navodilih za montažo in na  
**XS HR BA** Tartsa be a bútorelemek max. megengedett terhelési értékét. A részleteket lásd a szerelési útmutatóban  
**HU** Snaazáйте макс. допустимите стойности на натоварване на мебелите. За подробности виж ръководството за монтаж  
**BG** Додръжте макс. prípustné hodnoty zátizení nábykových dílů. Podrobnosti viz návod k montáži  
**CZ SK** Dodržujte max. přípustné hodnoty zatížení nábykových dílů. Podrobnosti viz návod k montáži  
**SE** Följ max. tillåten belastning av möbeldelarna. Mer information finns i monteringsanvisningen  
**RO** Respectați valorile de solicitare max. admise pentru corpurile de mobilier. Pentru detalii consultați instrucțiunile de montaj  
**ES** Respete los valores máximos de carga admisibles para las piezas de los muebles. Consulte los detalles en las instrucciones

**D CH AT LI LU** Zur Möbelföringung ein mit Wasser befeuchtetes, fusselfreies Baumwolltuch verwenden. Geeignigte Flächen immer trockenreiben!  
**GB US** To clean the furniture only use a water dampened lint-free cotton cloth. Once cleaned, always wipe the surfaces dry.  
**FR BE NC** Utilisez un chiffon en coton non pelucheux humidifié avec de l'eau pour nettoyer les meubles. Séchez systématiquement les surfaces  
**NL** nettooyes en les frottant!  
**IT** Gebrauk een met water bevochtigde, pluistvrije katoenen doek om de meubels te reinigen. Wrijf gereinigde oppervlakken altijd droog!  
**SI** Per pulire il mobile utilizzare un panno di cotone inumidito d'acqua e che non perde pelucchi. Asciugare sempre le superfici che si sono  
**XS HR BA** krpom!  
**HU** Za čišćenje pohištna uporabljajte vlažno bombažno krpo, ki ne pušča vlaken. Očišćene površine vedno obrišite do suhnega!  
**BG** Za čišćenje namještaja koristite sa vodom navlaženu pamučnu krpu koja ne ispušta vlakna. Očišćene površine uvijek obrišite suhom  
**CZ SK** K čištění nábytku používejte bavlněný hadr neuvolňující vlákna, navlhčený ve vodě. Učištěné plochy vždy utřete do sucha!  
**SE** För möbelföring används en luddfri bomullsduk fuktad med vatten. Rengjorda ytor ska alltid torkas torra!  
**RO** Pentru curățarea mobiliei utilizați o lavetă din bumbac fără scame umezită cu apă. Suprafețele curățate se șterg întotdeauna până se  
**ES** Emplee un paño de algodón humedecido con agua y libre de pelusa para la limpieza de los muebles. ¡Seque siempre las superficies que ha limpiado!