

MONTAGEANLEITUNG

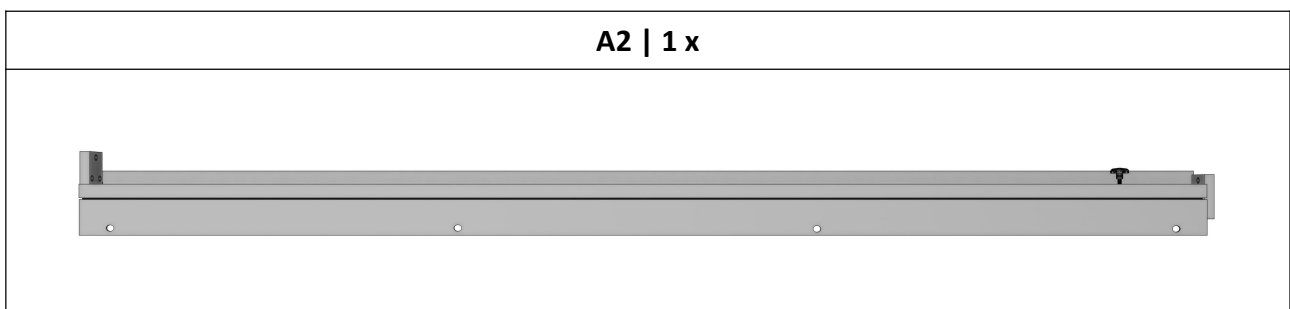

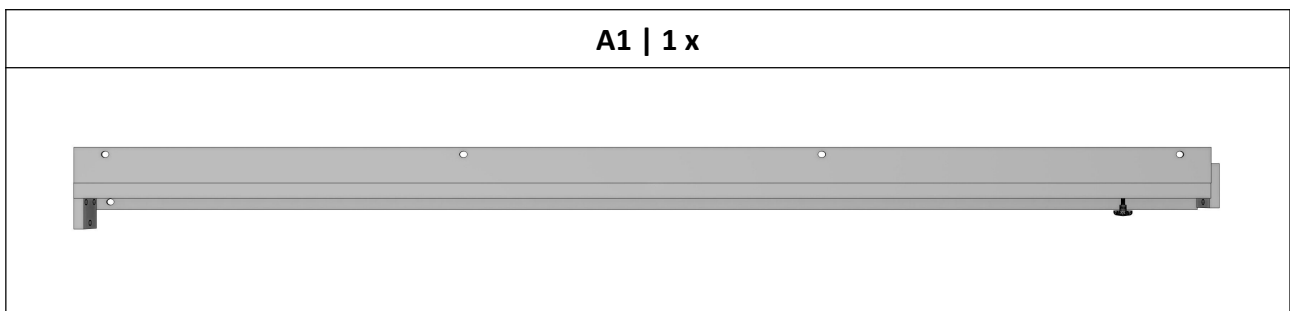

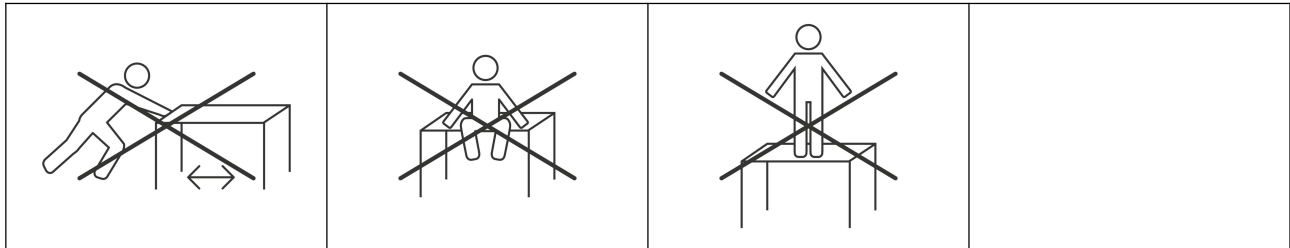

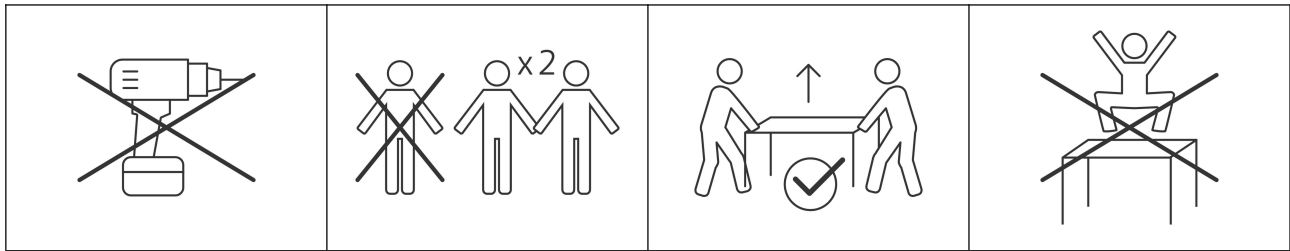





ASSEMBLY INSTRUCTION

NOTICE DE MONTAGE

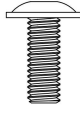





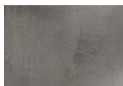
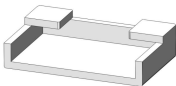

B1 1 x	B2 1 x	C 12 x M 8 x 30	D 1 x 5 mm

E 1 x	F 6 x M 6 x 12	G 6 x M 6	H 2 x Ø 16 mm
			
I 1 x 4 mm	J 2 x	K 4 x M 6 x 16	L 4 x
			
M 4 x M 6 x 15,5	N 2 x	O 1 x	P 8 x M 5 x 12
			
Q 8 x Ø 12 mm	R 1 x	S 4 x	
			

1.

A1 1 x	A2 1 x	B1 1 x	B2 1 x
			

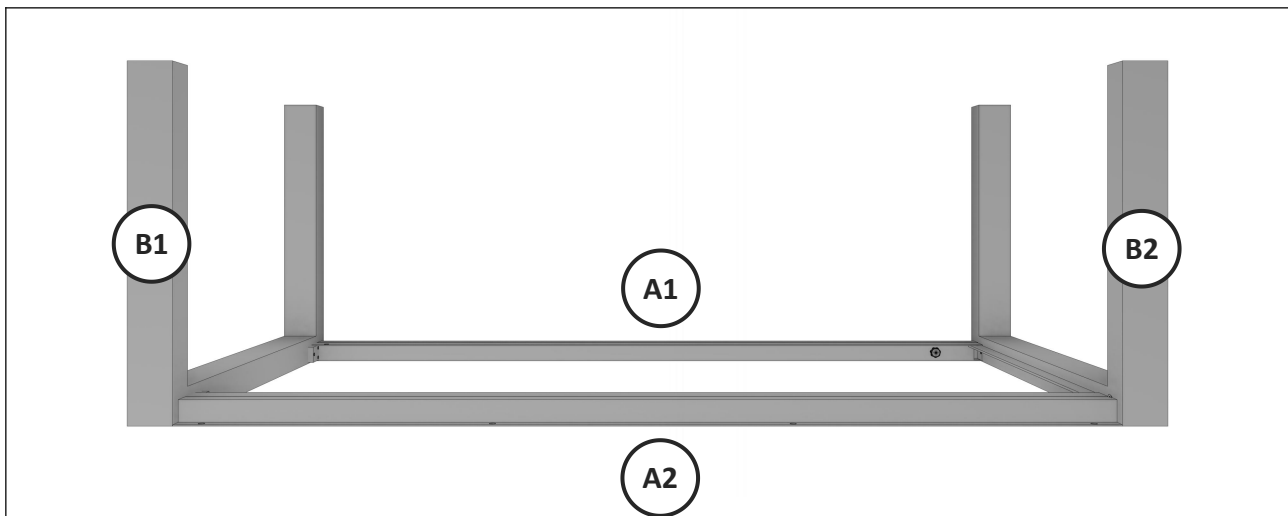

Der Aufbau sollte auf einem ebenen und weichen Untergrund erfolgen.
Verwenden Sie beispielsweise das Verpackungsmaterial zum Schutz vor Beschädigungen.

The setup should be done on an even and soft floor.
For example, use the carton packing material in order to avoid any damages.

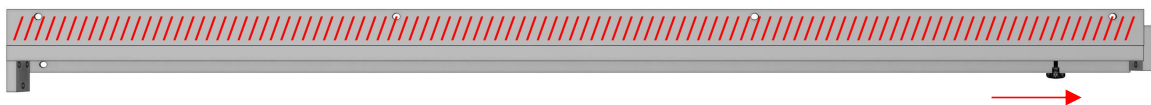

L'installation doit être effectuée sur un sol plat et protégé.
Par exemple utilisez le carton d'emballage pour éviter des endommagements.



Auszug mit dieser Fläche nach unten auf den Boden legen
Place the pullout on the floor with this surface facing downwards
Placez les glissières avec les 4 trous de fixation du plateau contre le sol

Die Verstellerschrauben zeigen immer nach rechts.
The adjustment screws always point to the right.
Les vis de réglage sont toujours orientées vers la droite.

2.

C 12 x	D 1 x				
					

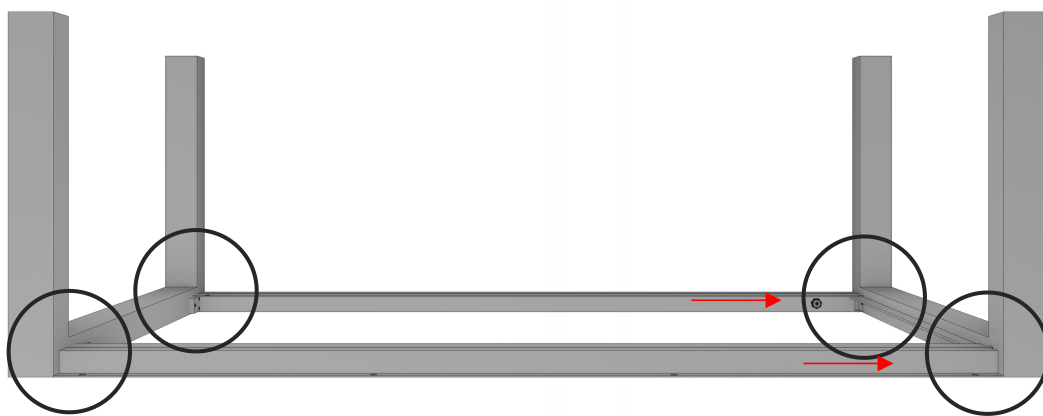

Achtung: Alle Schrauben zuerst nur handfest anziehen, dann Gestell umdrehen.

Attention: Always tighten all screws by hand first then turn the frame.

Attention: Serrez d'abord toutes les vis à la main puis retourner l'ensemble

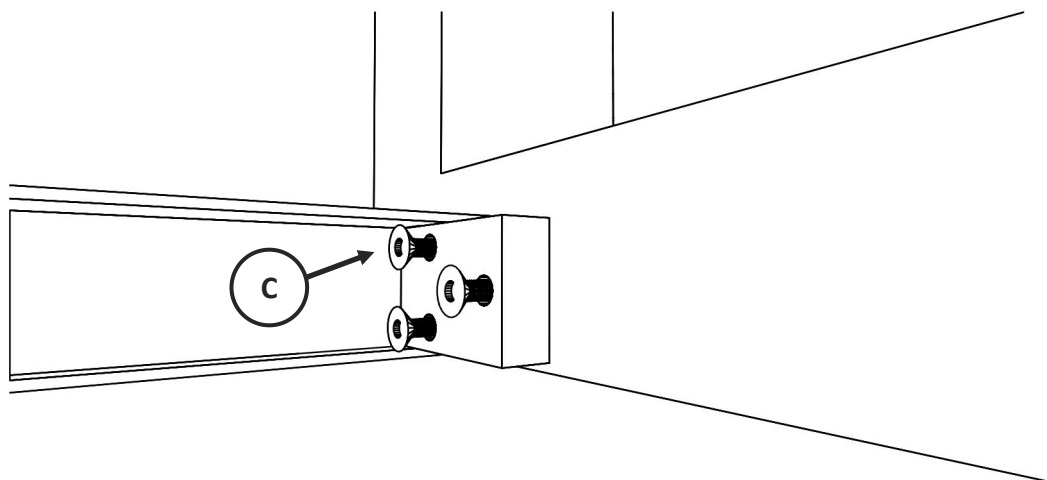

3.

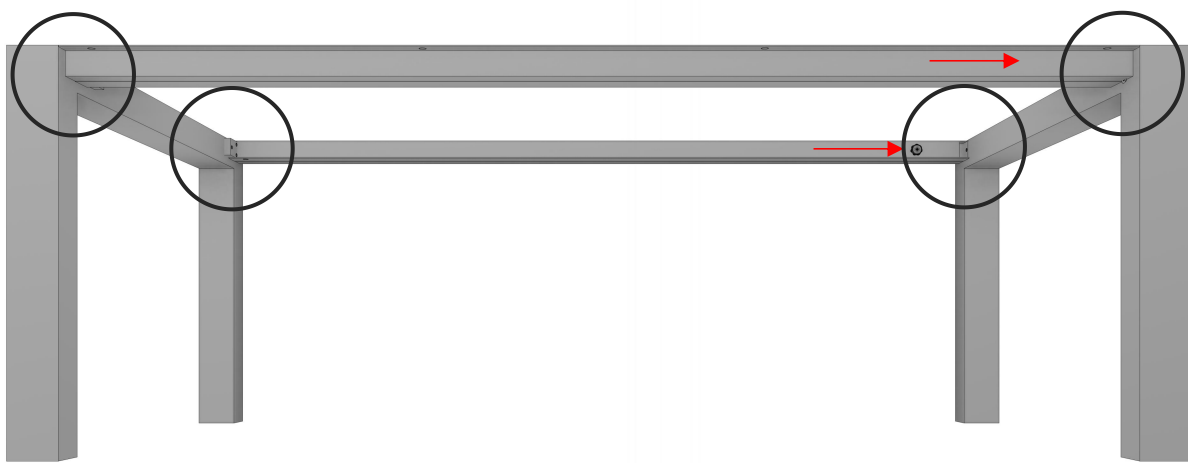





Ausziehtisch komplett zusammenschieben und alle zugänglichen Schrauben fest anziehen, dann etwas auseinander ziehen und die restlichen Schrauben fest anziehen.

Pull in the extension table completely and tighten all accessible screws. Then extend the table a little bit and tighten the remaining screws.



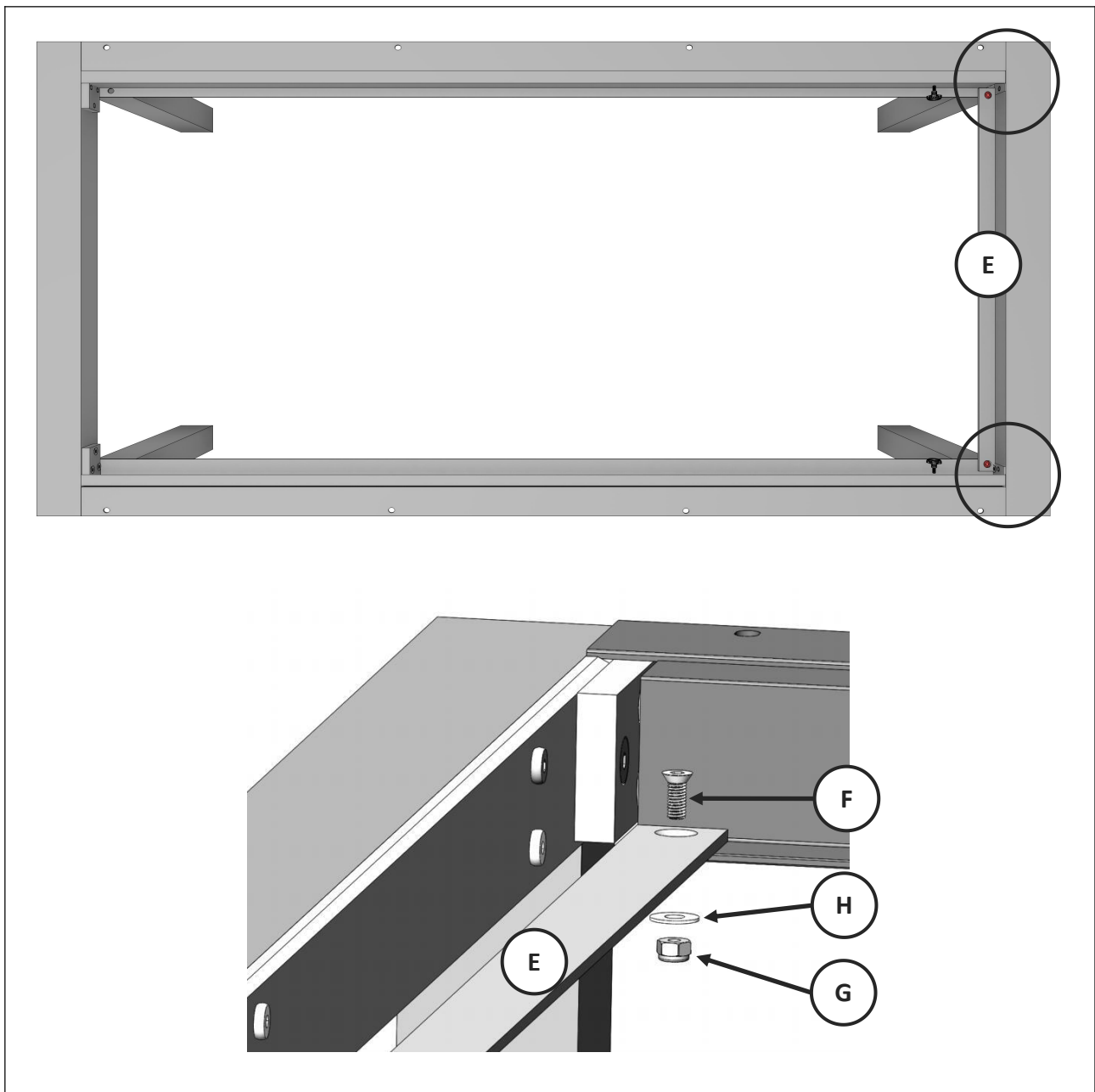

Rentrez complètement les glissières et serrez toutes les vis qui sont accessibles puis laissez environ 30 cm d'ouverture et serrez les autres vis.

4.

E 1 x	F 2 x	G 2 x	H 2 x	I 1 x	
					





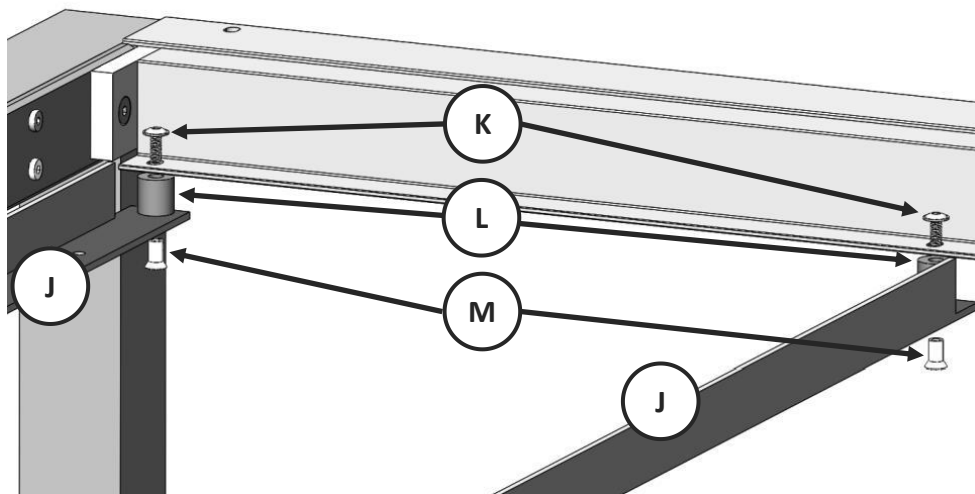
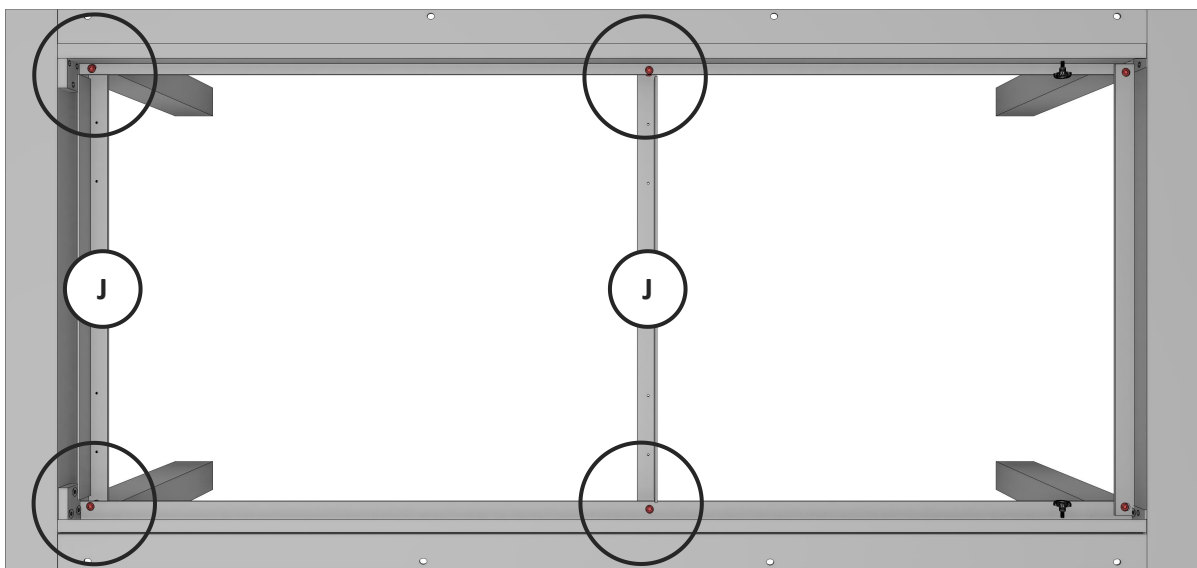

5.

J 2 x	K 4 x	L 4 x	M 4 x	I 1 x	
					





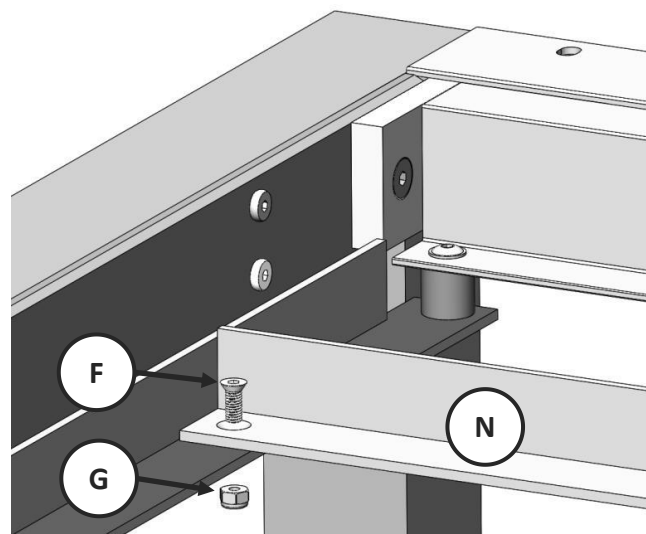
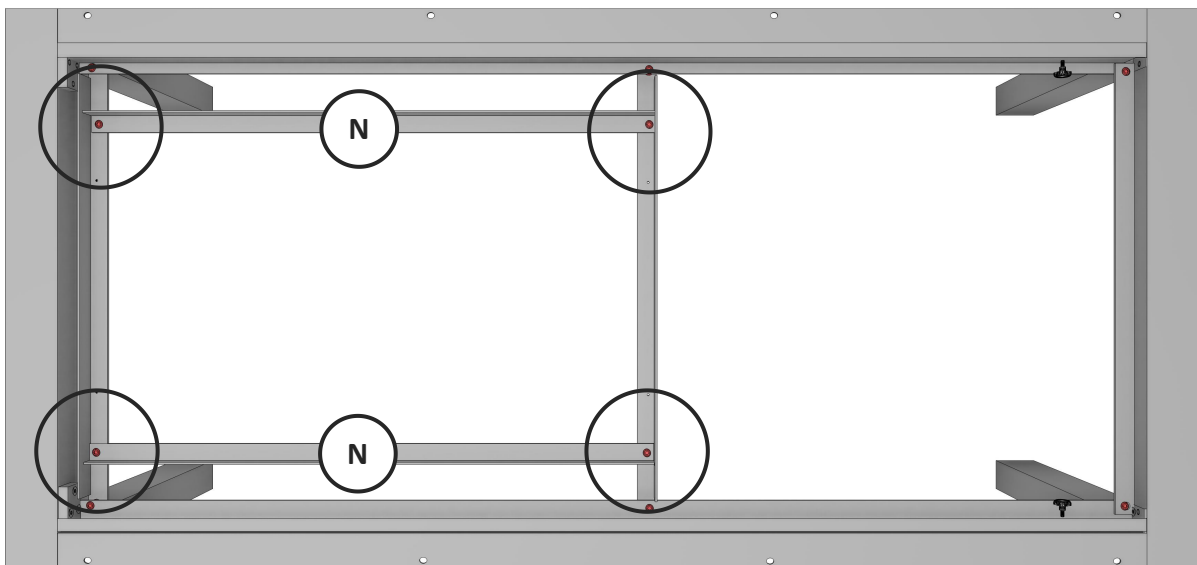

6.

N 2x	F 4x	G 4x	I 1x		
					

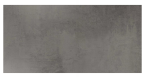

7.

O 1x	P 8x	Q 8x	I 1x		
					

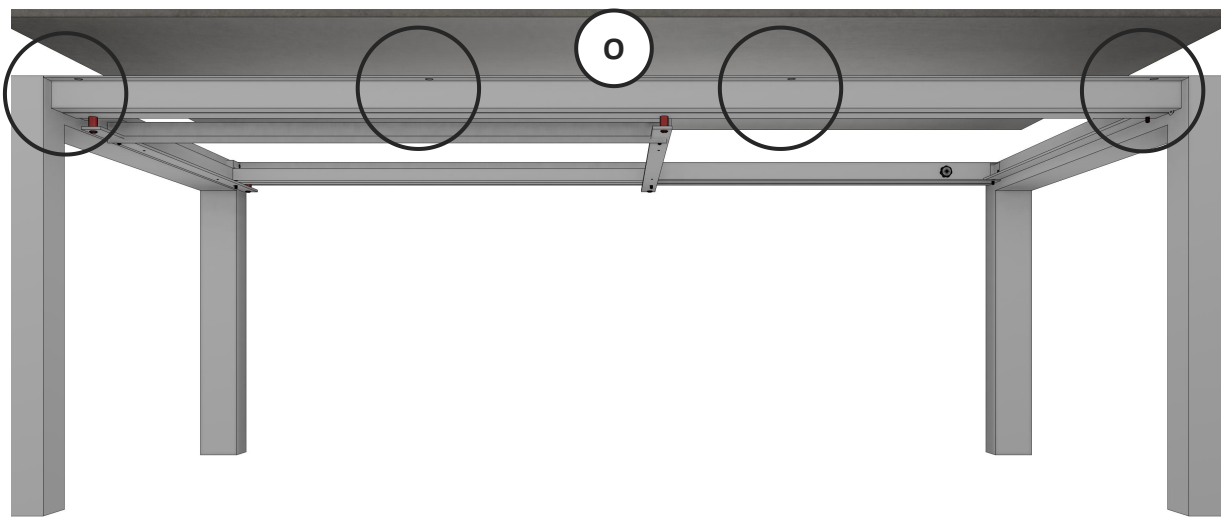

Platte auf den Tischrahmen legen, ausrichten und mit den Auszügen verschrauben.
Place the plate on the table frame, align it and screw it with the guide rails.
Placez le plateau sur le cadre de la table, alignez-le puis vissez le avec les glissières.

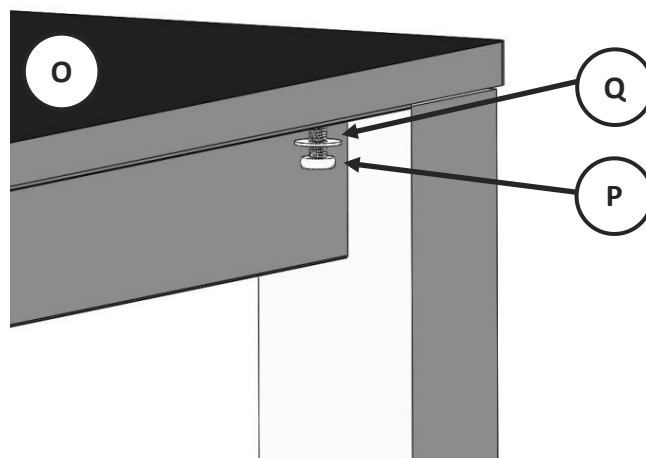

8.

R | 1 x

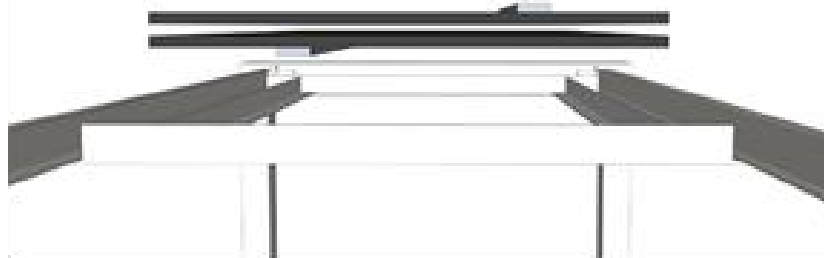

Optional ist eine zweite Einlegeplatte erhältlich. Beide Platten wie abgebildet verstauen.

A second insert plate is optionally available. Stow both tops as shown.

Une deuxième allonge est disponible en option. Ranger les deux allonges comme indiqué.

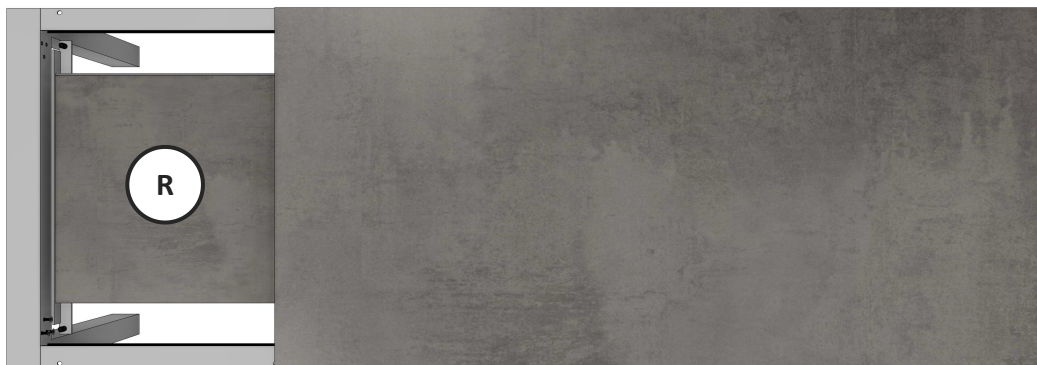

9.

S | 4 x

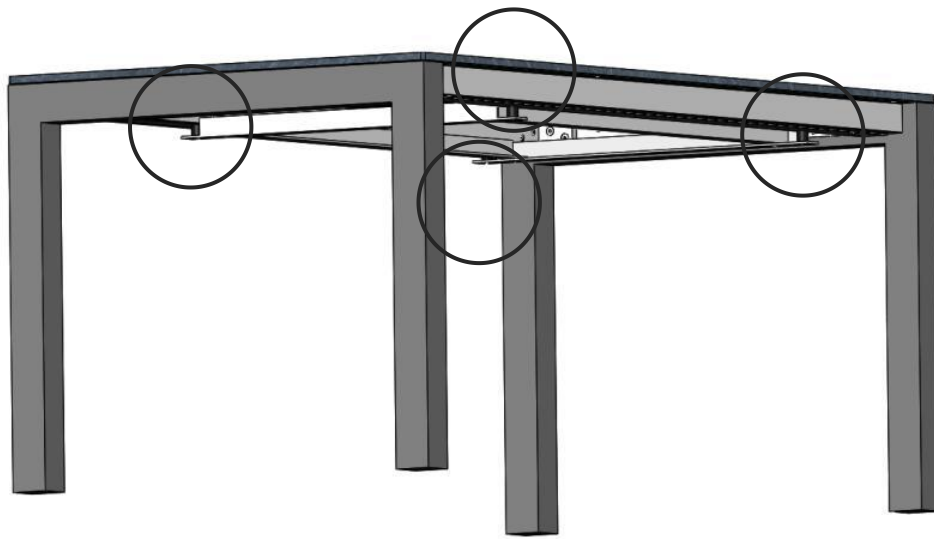
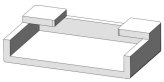

Jeweils auf beiden Seiten anbringen.
To be applied on both sides.
Appliquez des deux côtés.

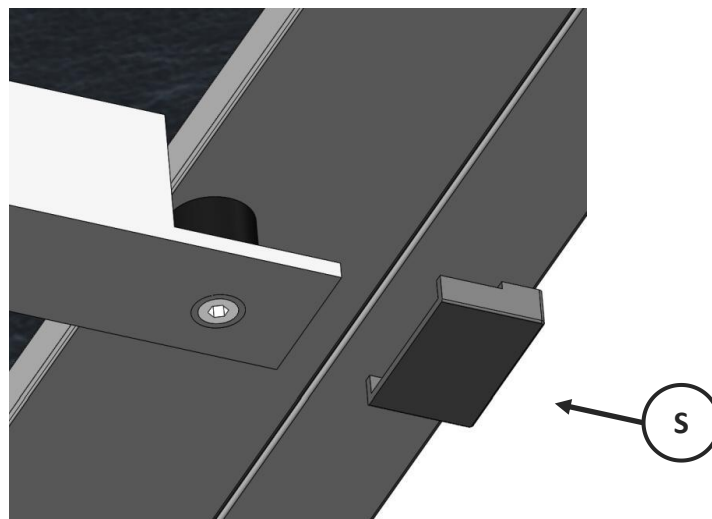

10.

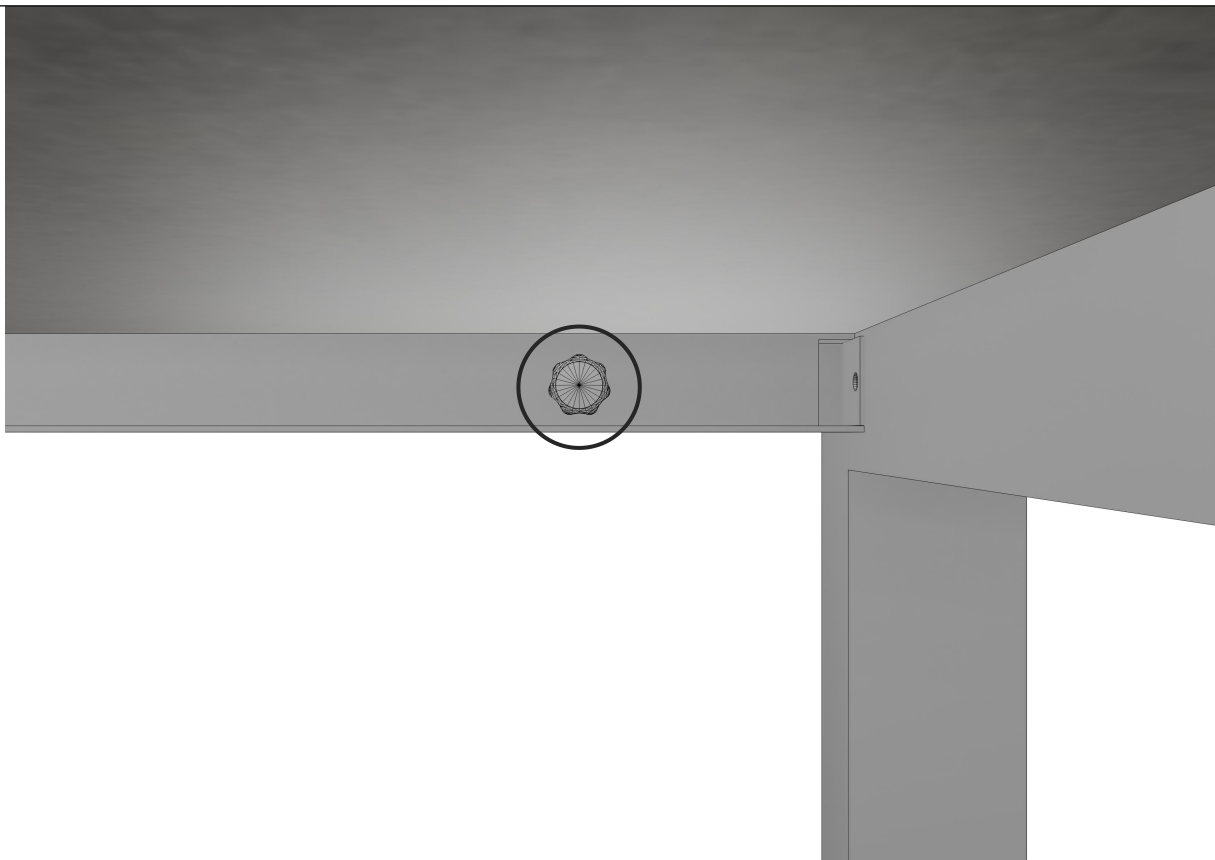

Achtung Feststellschrauben – vor dem Auseinanderziehen und Zusammenschieben bitte lösen

Attention locking screws – please loosen before extending and pushing together



Attention vis de verrouillage – veuillez desserrer avant de faire coulisser la table

11.

Bei Bedarf können die auf der ausziehbaren Seite werkseitig vormontierten Rollen gegen Höhenversteller ausgetauscht werden

If necessary, the wheels pre-mounted at the factory on the extendable side can be exchanged for height adjusters

Si nécessaire, les roulettes pré-montées en usine sur le côté mobile peuvent être remplacées par des sur-élévateurs (sols non réguliers)

	
<p>Höhenversteller height adjuster sur-élévateur</p>	<p>Rolle wheel roulette</p>

	
<p>Rolle herausnehmen remove the wheel Retirer la roulette</p>	<p>Höhenversteller eindrehen Screw in height adjuster Ajuster le sur-élévateur</p>