

L

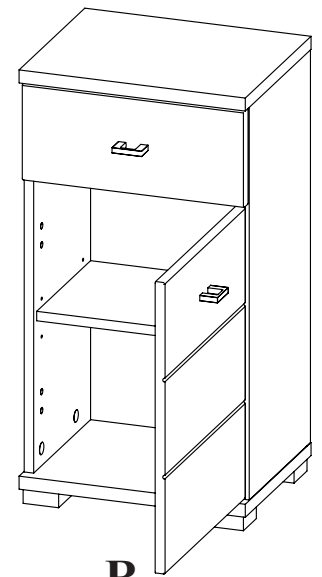

R

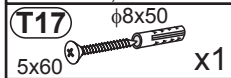
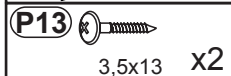
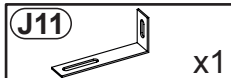
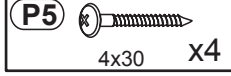
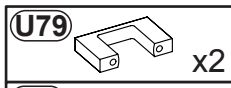
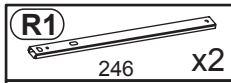
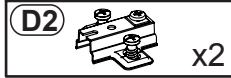
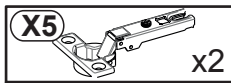
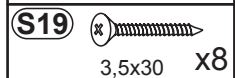
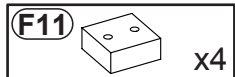
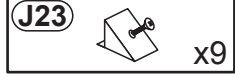
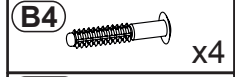
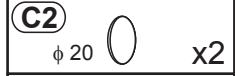
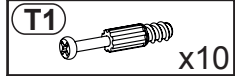
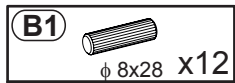

Nr	Ausmaß			St
1	250	120	12	1
2	250	120	12	1
3	316	120	12	1
4	376	161	16	1
5	494	376	16	1
6	665	284	16	1
7	665	284	16	1
8	348	250	16	1
9	382	305	22	2
10	327	249	2	1
11	679	362	2	1

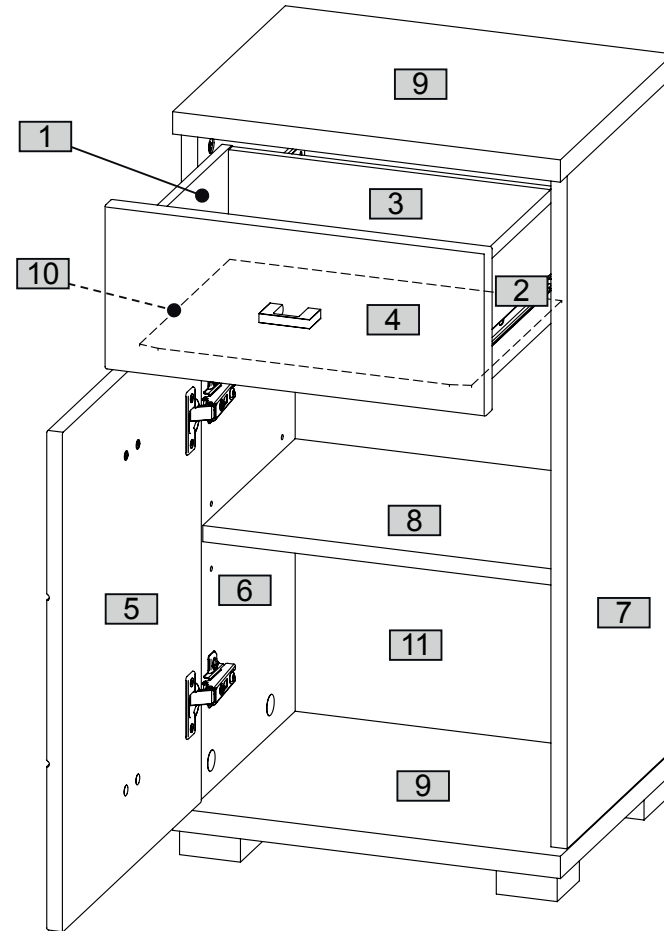

0 10 20 30 40 50 60 70 80 90 100 110 120 130 140 150 160 170 180 190 200



1

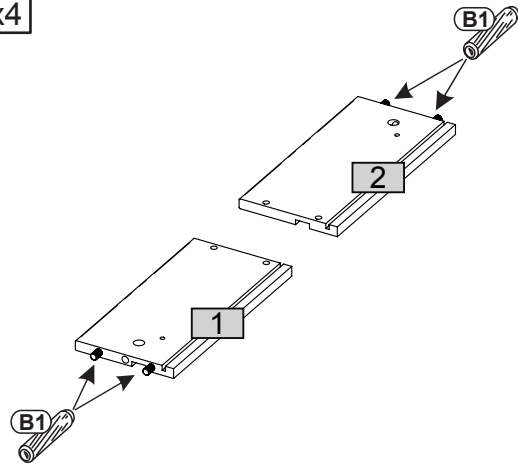
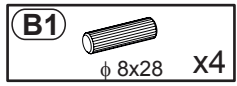

2

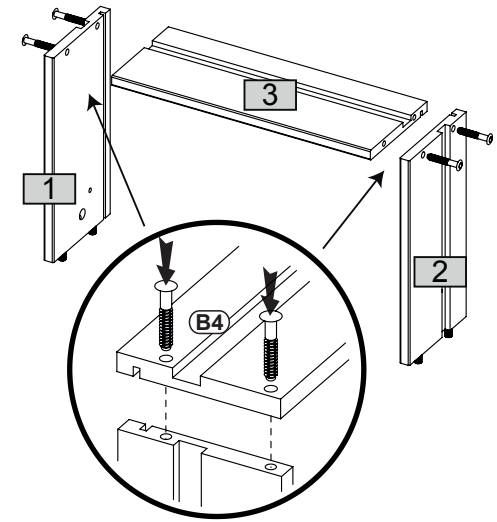
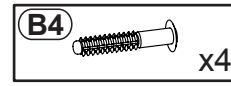

3

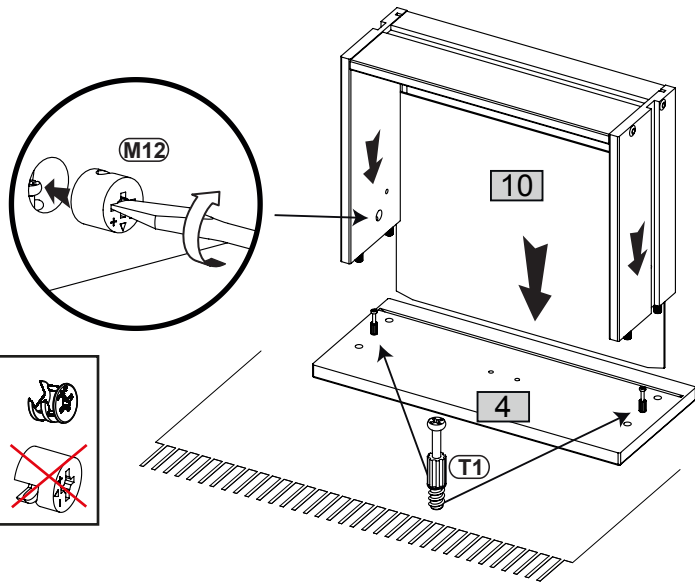
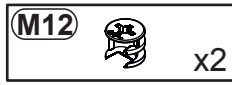
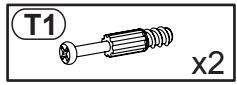

4

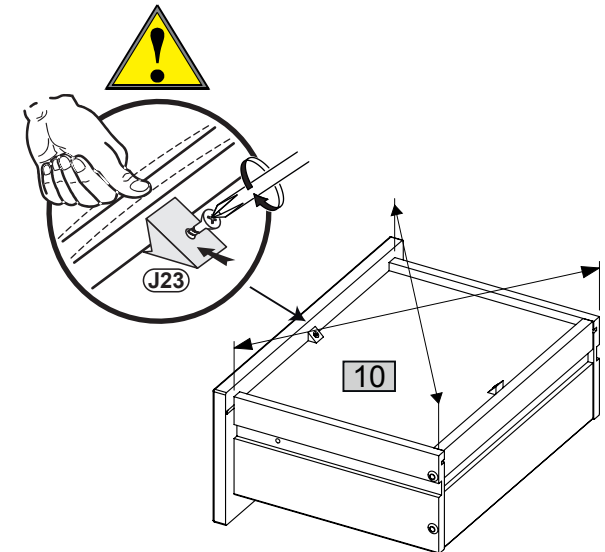
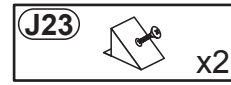

5

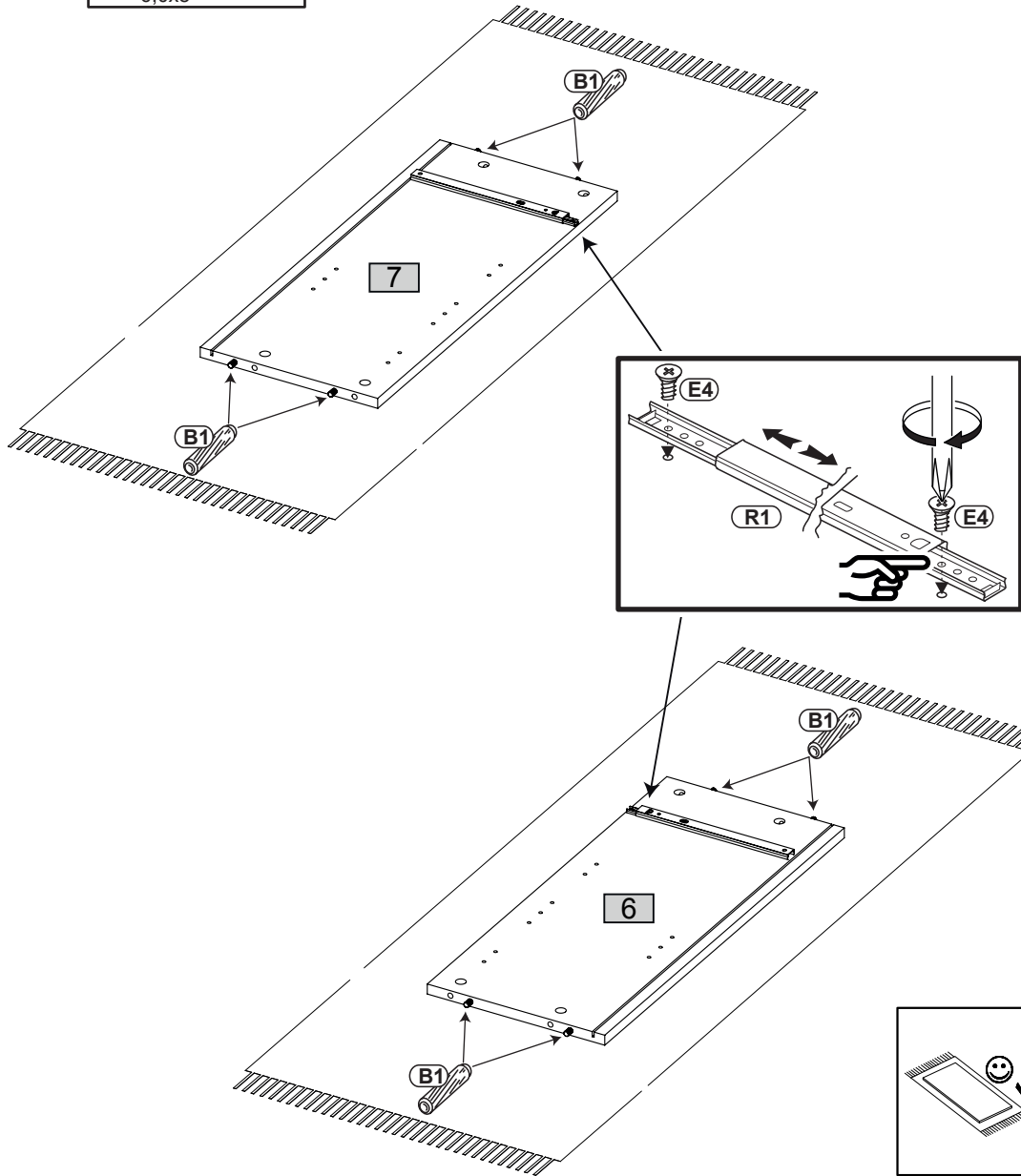
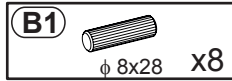
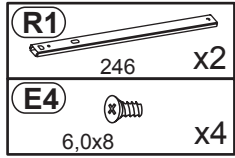

6

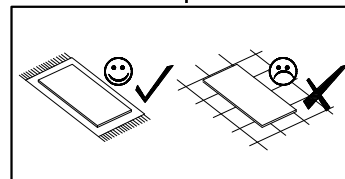
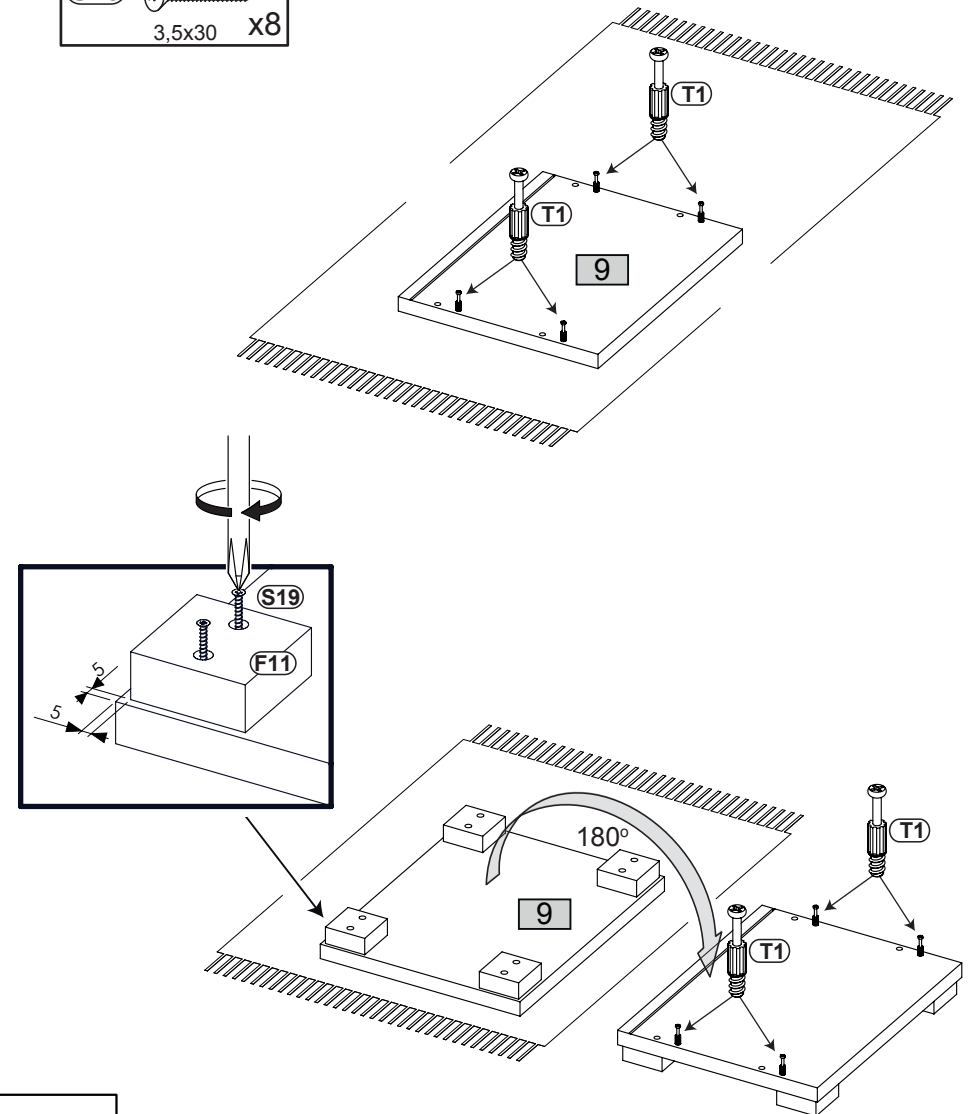
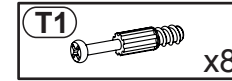
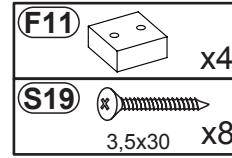

7

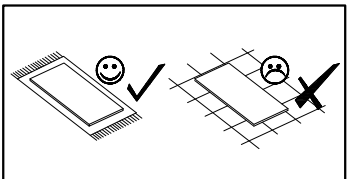
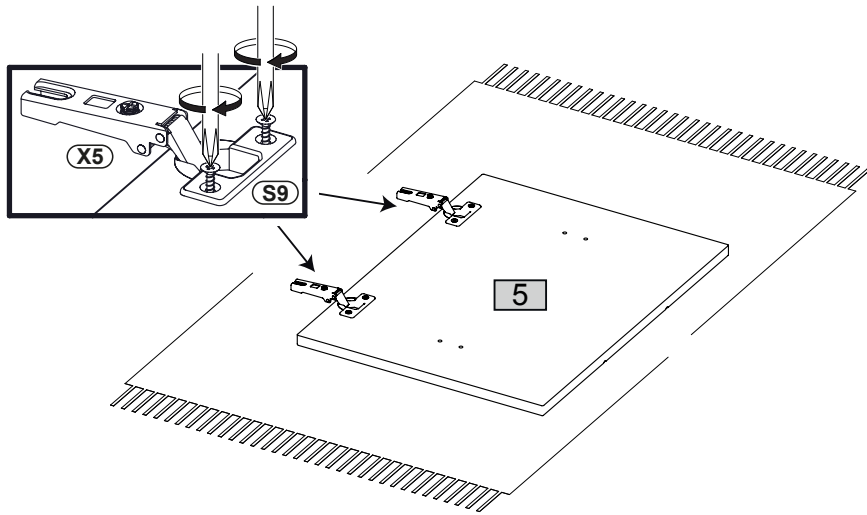
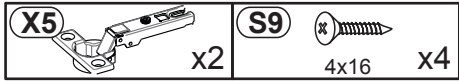

8

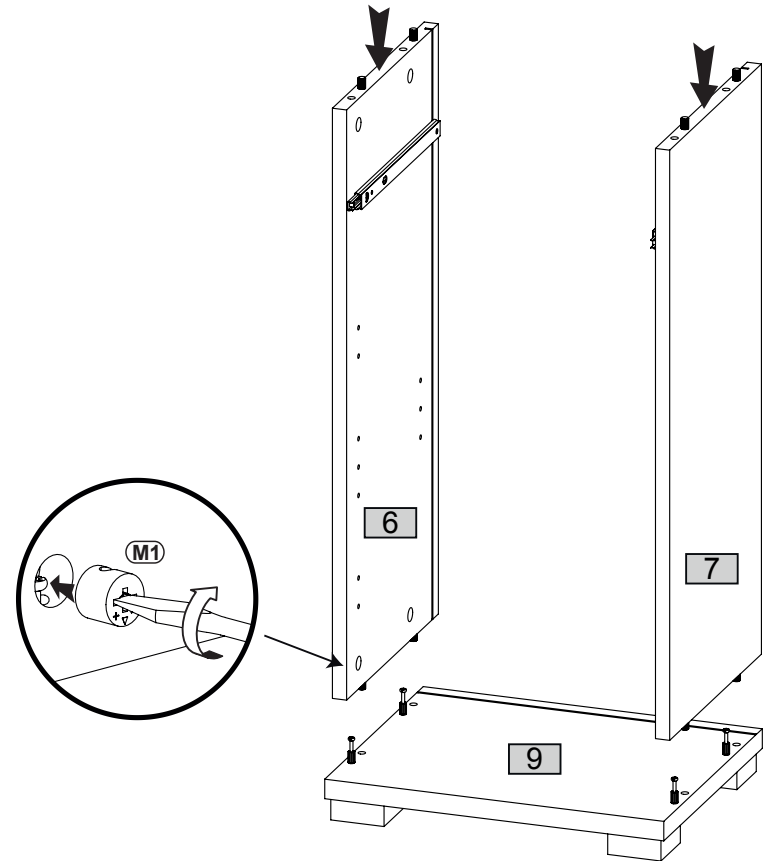

**9** **M1**  x4

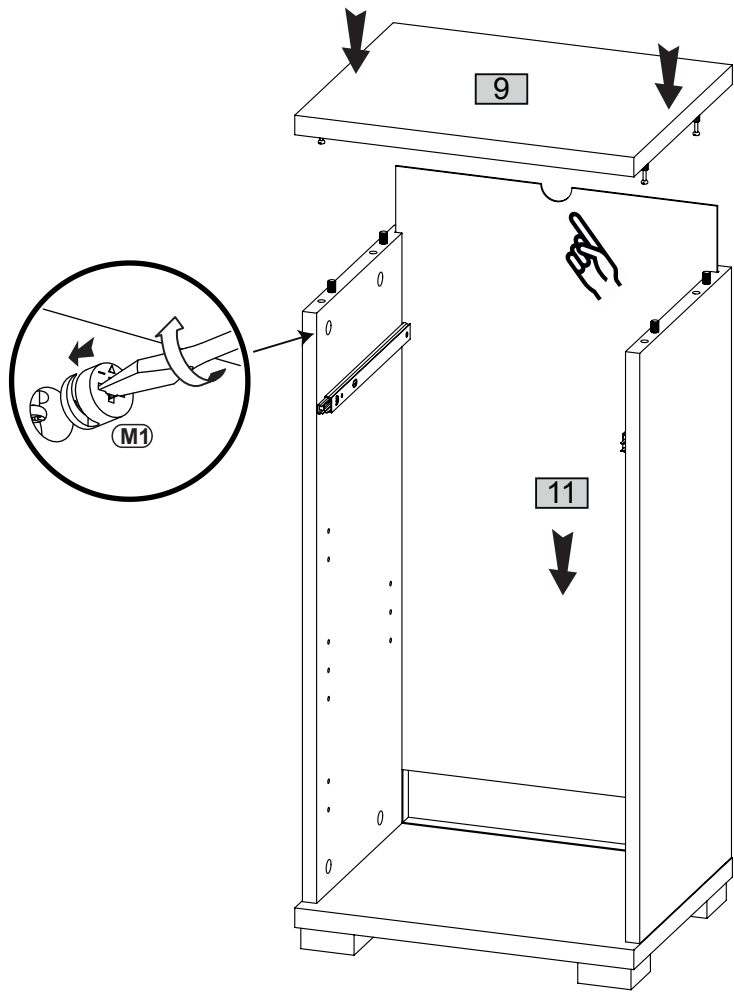

**10** **J23**  x7

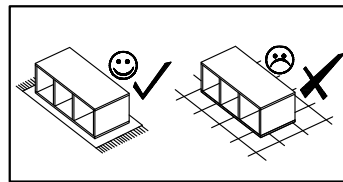
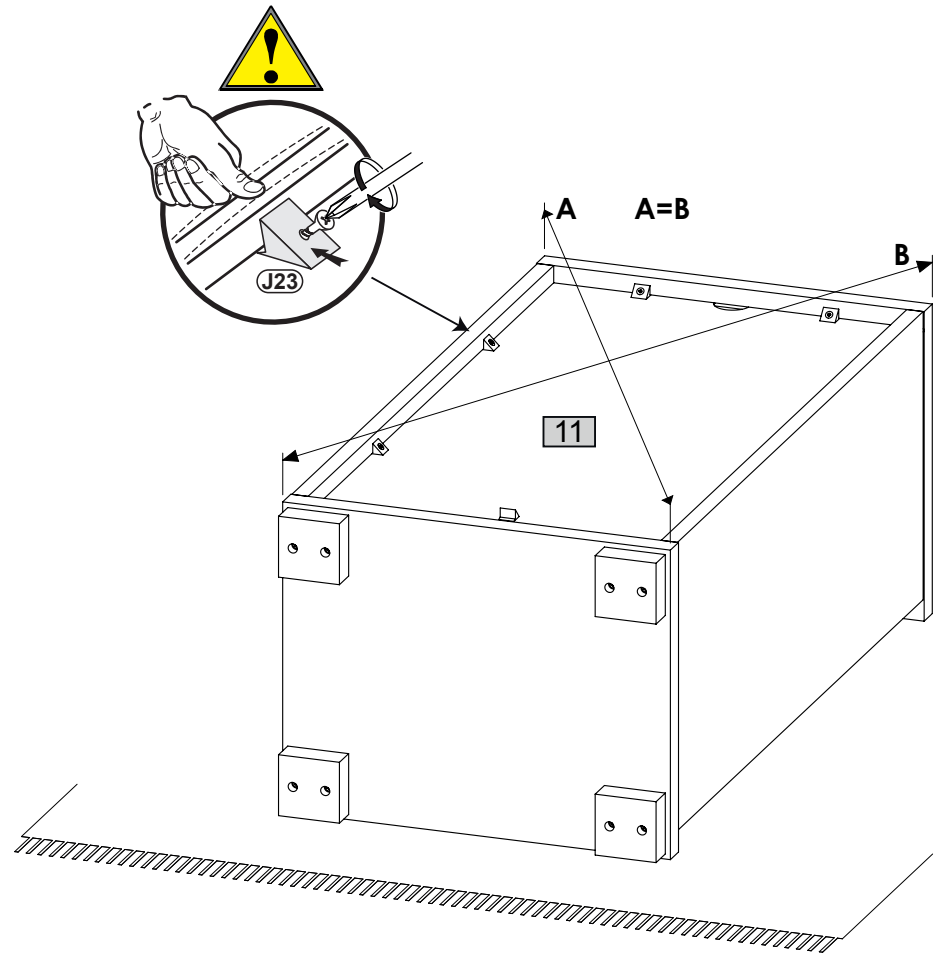

11L

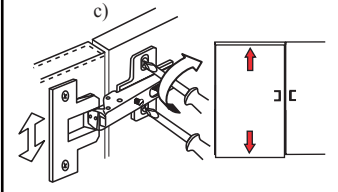
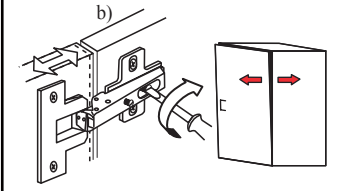
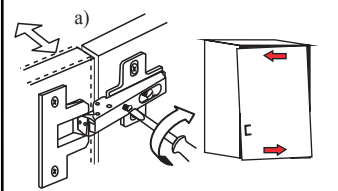
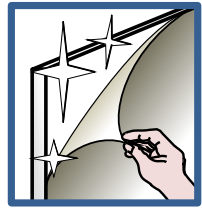
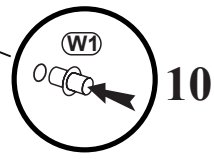
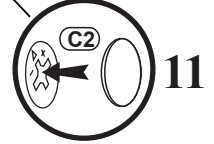
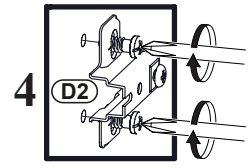
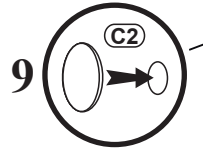
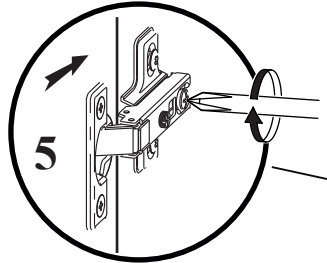
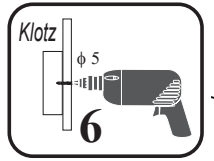
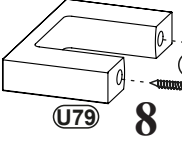
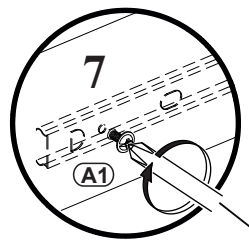
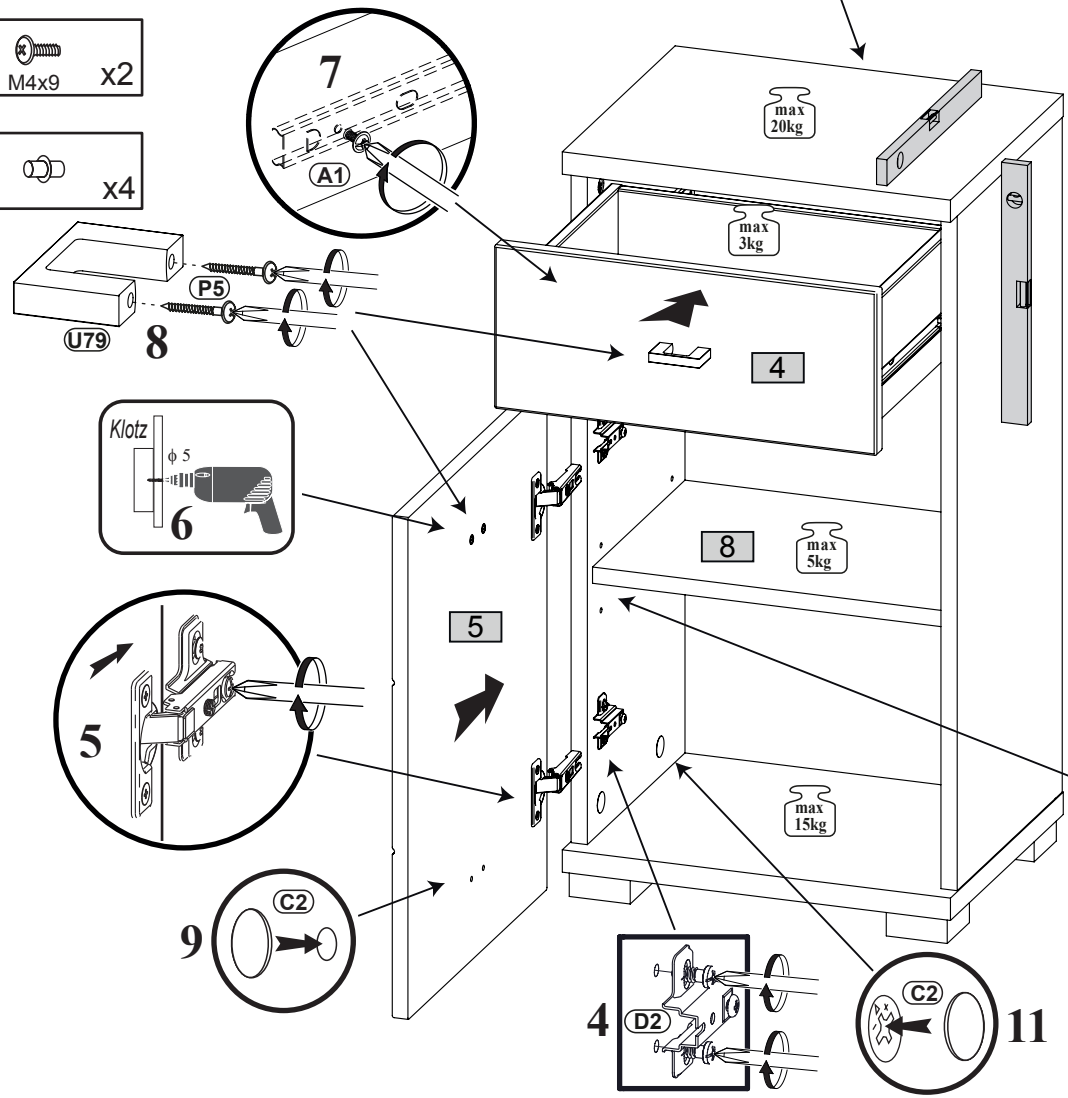
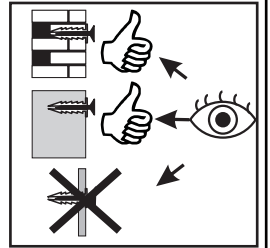
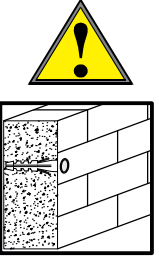
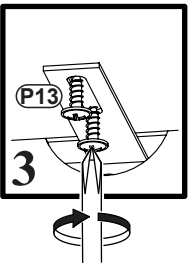
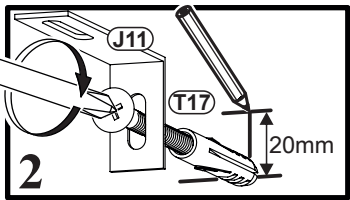
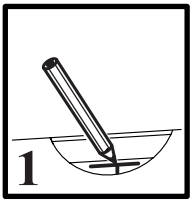
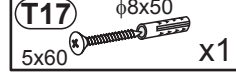
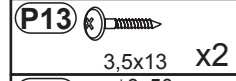
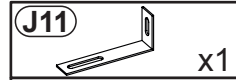
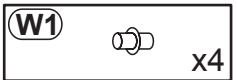
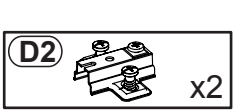
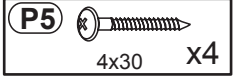
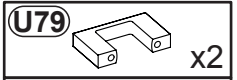

11R

