

REPC-Nr.:

Service • Assistenza • Dienstverlening • Serwis  
Servis • Szerviz • Сервисная служба



Artikel.-Nr.:

**0472\_32**

Montageanleitung.-Nr.:

**MA1-00111**

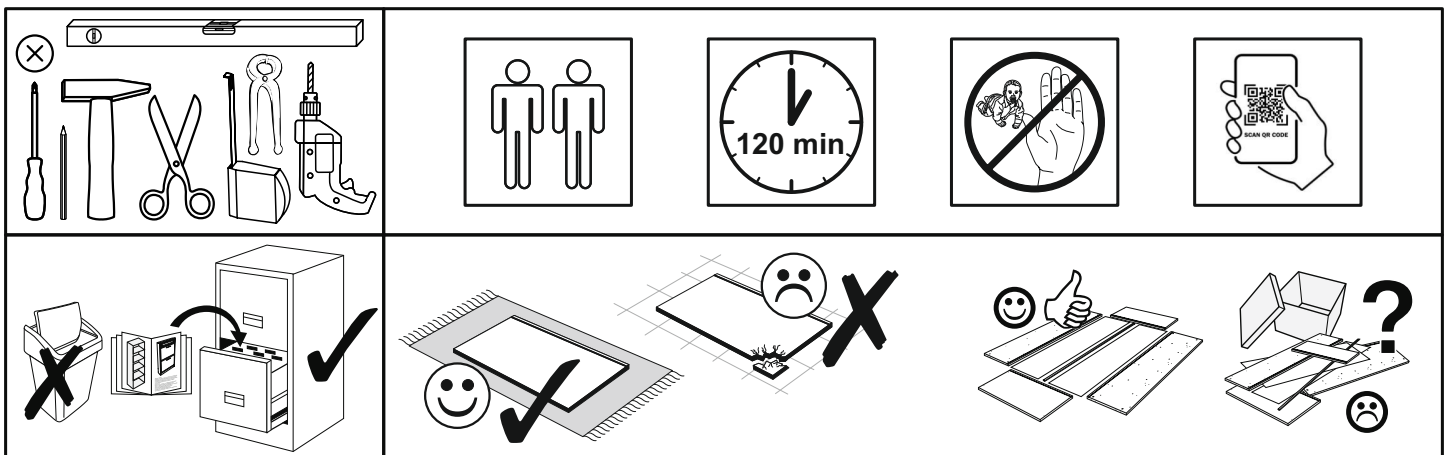

SCAN ME

Das Ersatzteil-Anforderungsformular finden Sie auf  
The replacement parts requisition form you find on  
<https://www.maeusbacher.de/ersatzteile/>

## Beutel 0472\_32 0-13 Colli 2/3

B01-10 8x 6,3x50	B01-30 40x 3x16	B01-80 24x 3,5x13	B01-90 22x 3,5x20	B02-10 26x h=12mm
B02-20 26x	B02-114 2x	B02-120 1x	B03-42 3x 8er	B01-140 26x 4x30
B01-200 8x 6,3x13	B02-160 12x	B03-11 3x		



▶ SCAN ME

## Beutel 0472\_32 0-23 Colli 2/3

3-07 3x	3-25 6x	3-26 6x 45°
------------	------------	-------------------

## Beutel 0472\_32 0-33 Colli 2/3

B01-70 4x 3x30	B02-08 8x h=10mm	B02-20 8x	B05-185 18x L = 20 mm	B05-190 4x	B06-312 5x 128 mm
B08-80 1x					

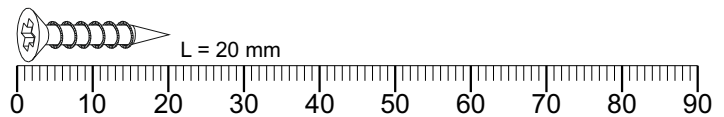

## Colli 1/3

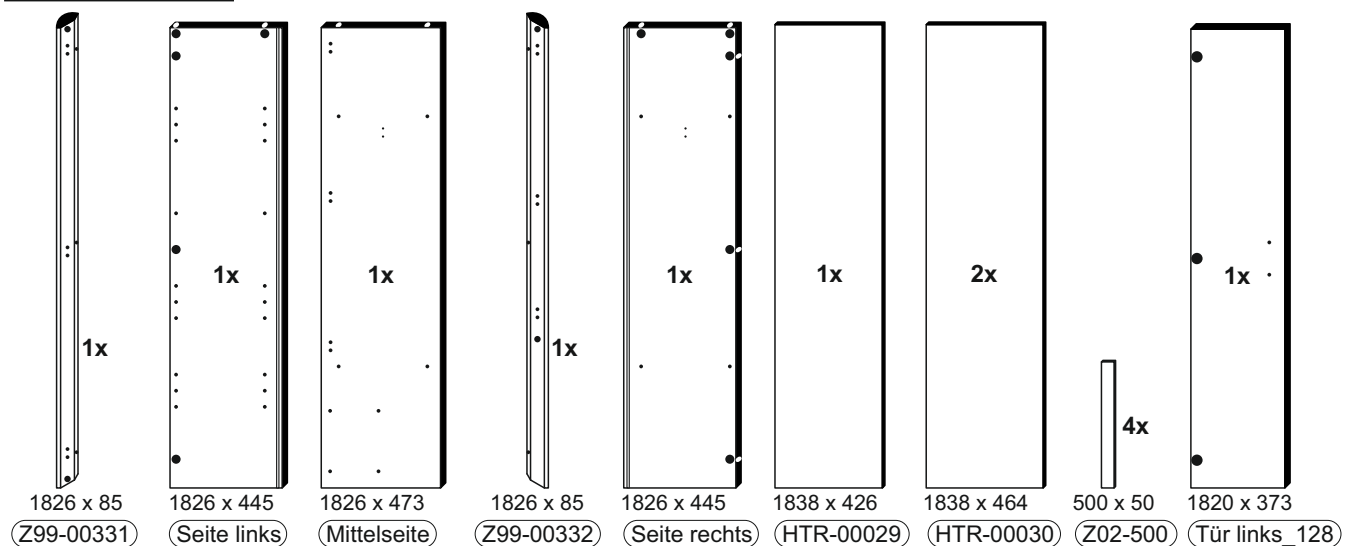

## Colli 2/3

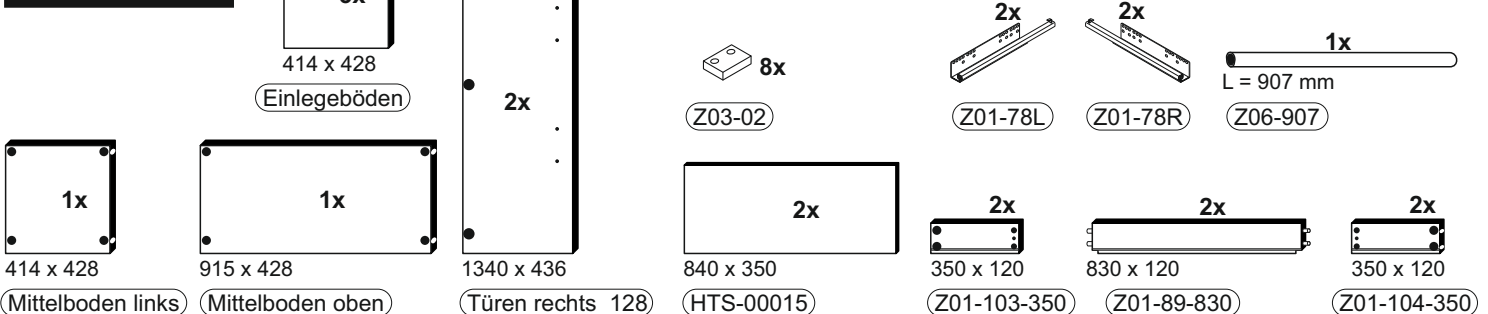

## Colli 3/3

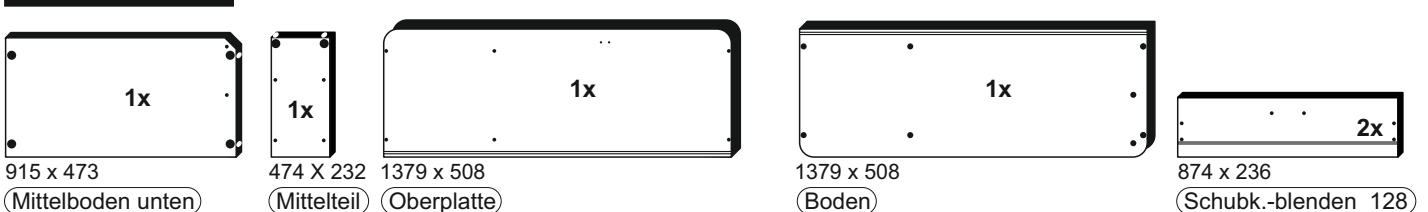

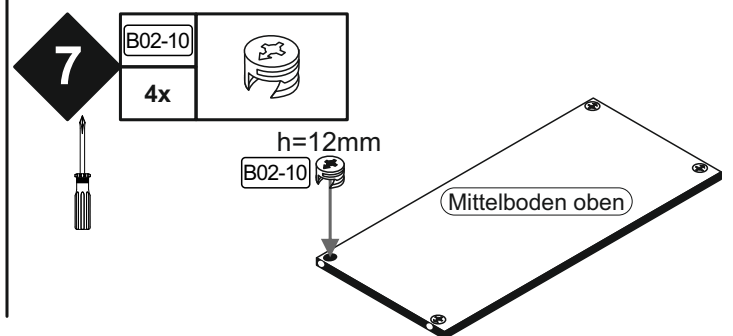
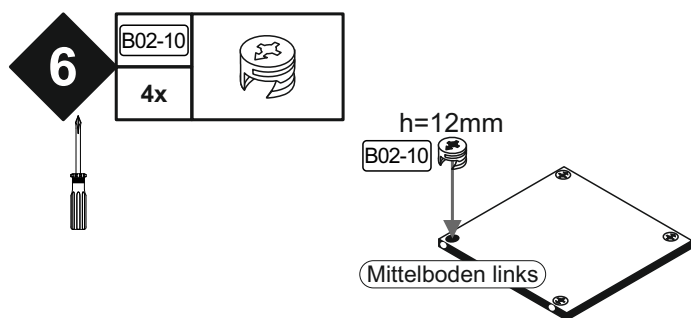
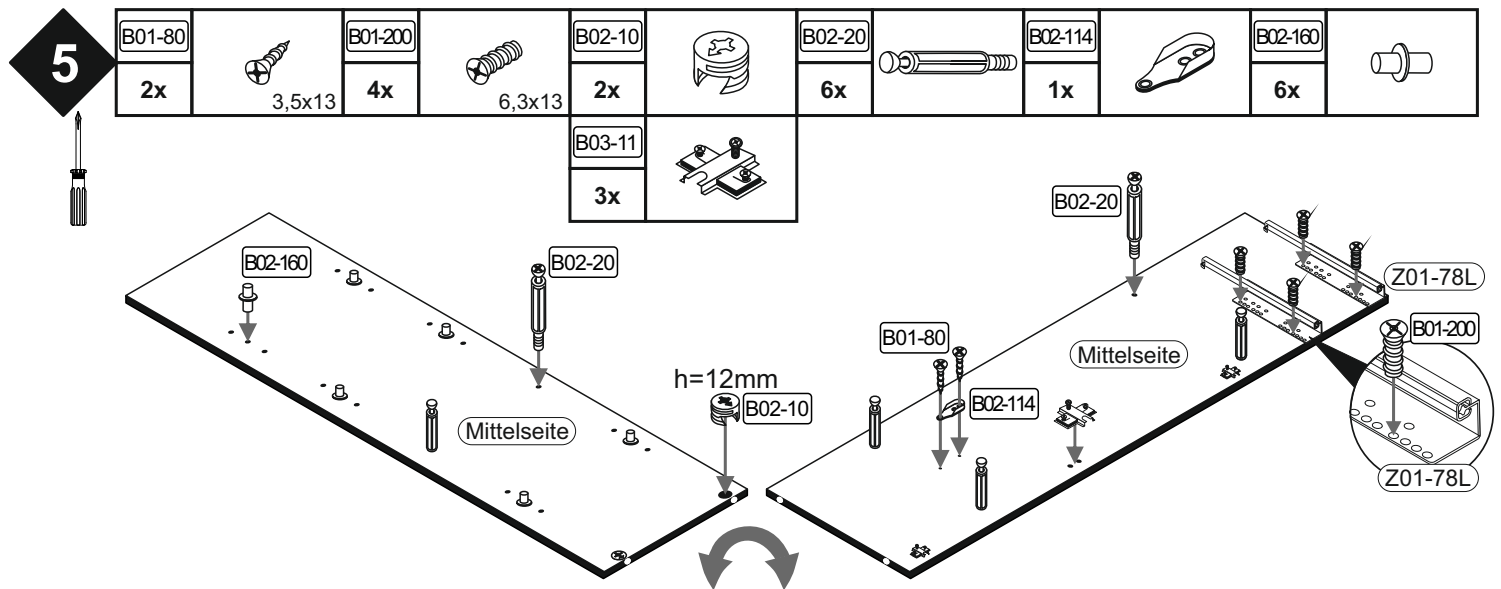
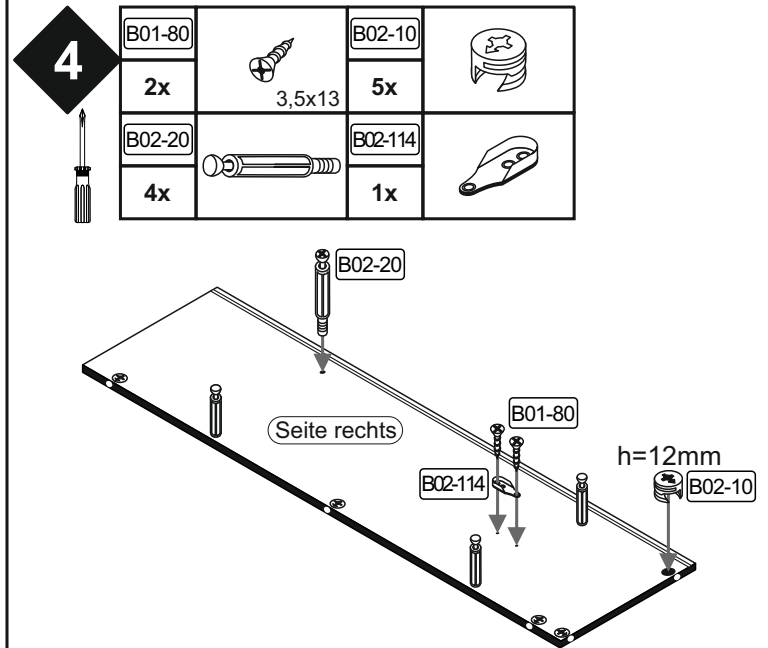
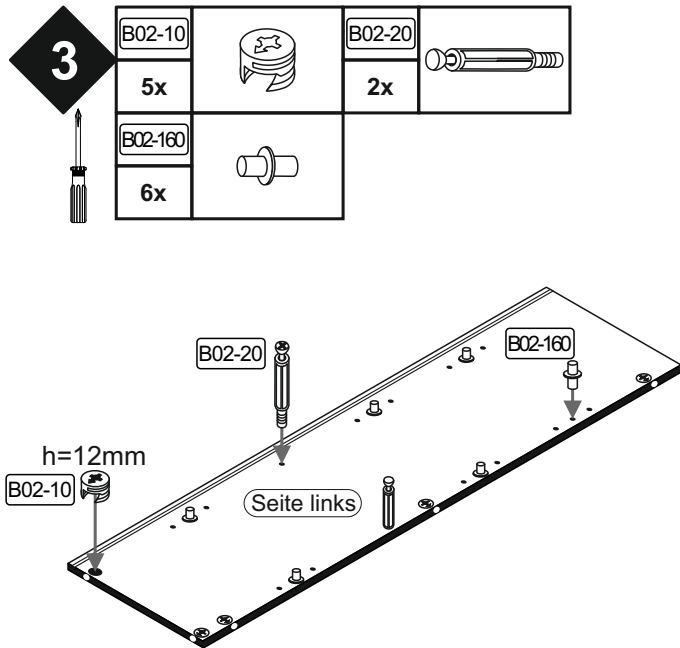
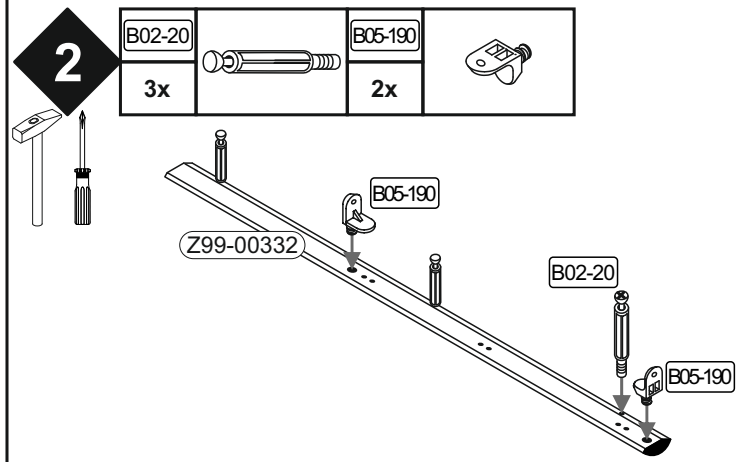
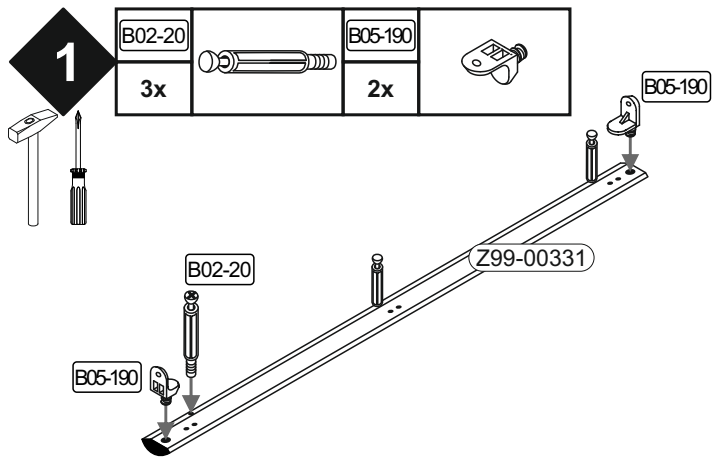

**8**

B02-10		B02-20	
4x		2x	

h=12mm

B02-10 B02-20

Mittelboden unten

**9**

B01-200		B02-10	
4x	6,3x13	2x	

Z01-78R B01-200 h=12mm B02-10

Z01-78R B01-200

Mittelteil

**10**

B01-80		B02-20	
2x	3,5x13	6x	
B02-120			
1x			

Oberplatte

B01-80 B02-20 B02-120

**11**

B01-80		B03-26	
6x	3,5x13	3x	45°

Tür links 128

B01-80 B03-26

**12**

B01-80		B03-26		B03-42	
12x	3,5x13	3x	45°	3x	8er

Türen rechts 128 M

B01-80 B03-42

Türen rechts 128 R

B01-80 B03-26

**13**

B01-140		B02-08		B02-20		B06-312	
4x	4x30	8x		8x		2x	128 mm

Schubk.-blenden 128

B01-140 B02-20 B06-312

B02-08 h=10mm B02-08

Z01-103-350 Z01-104-350

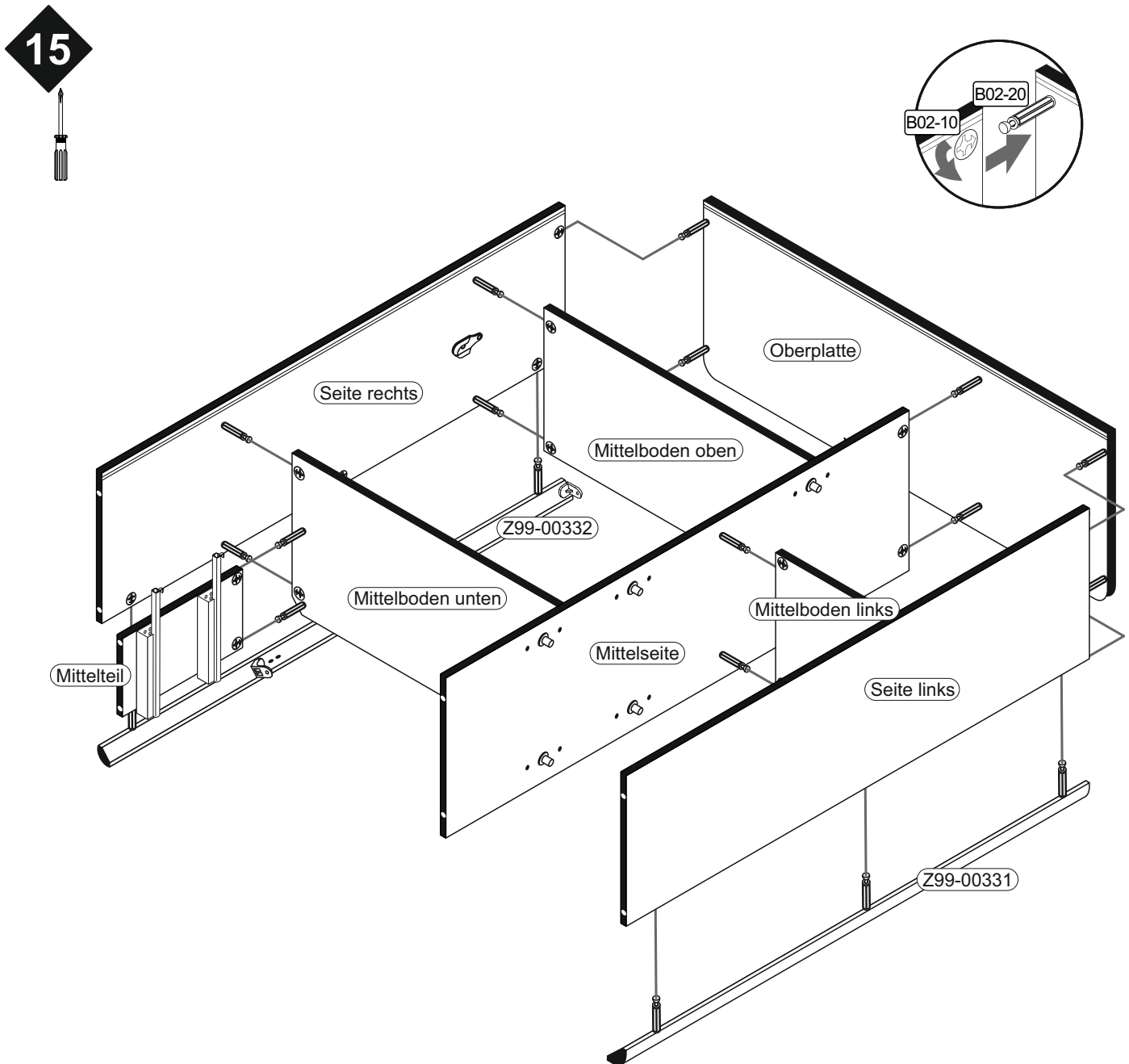
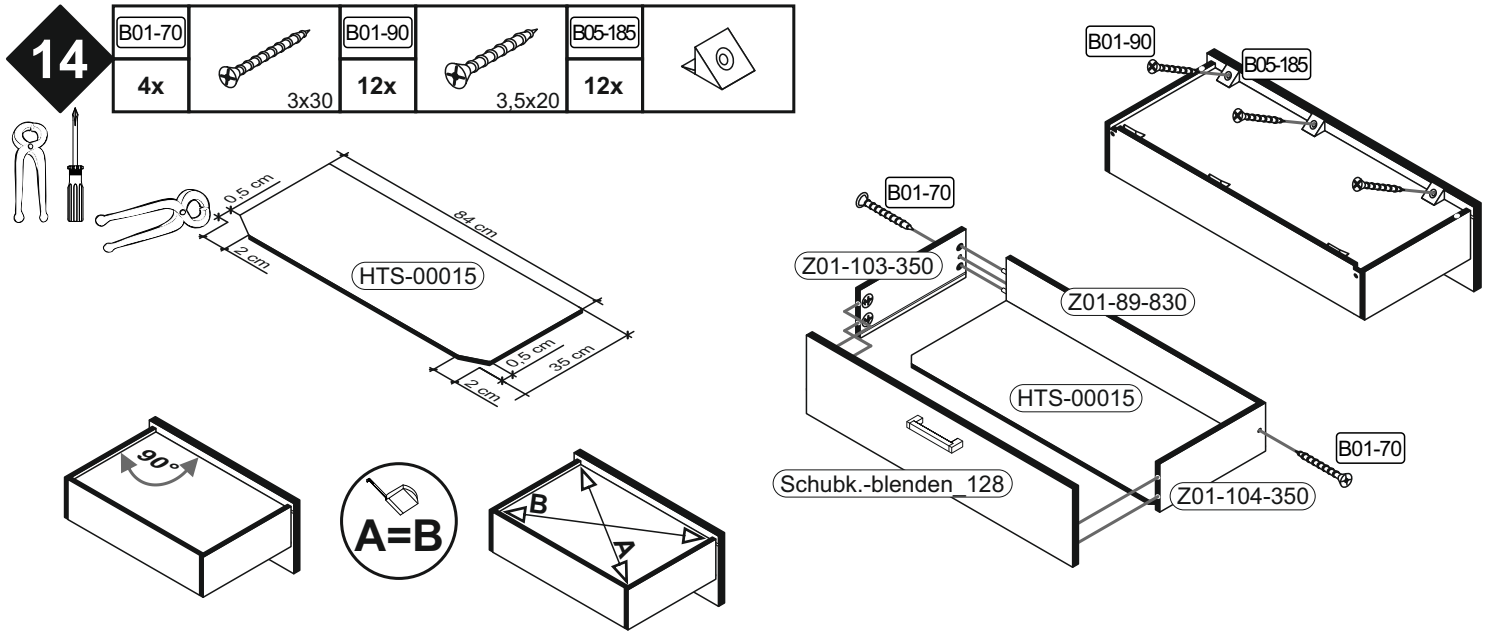

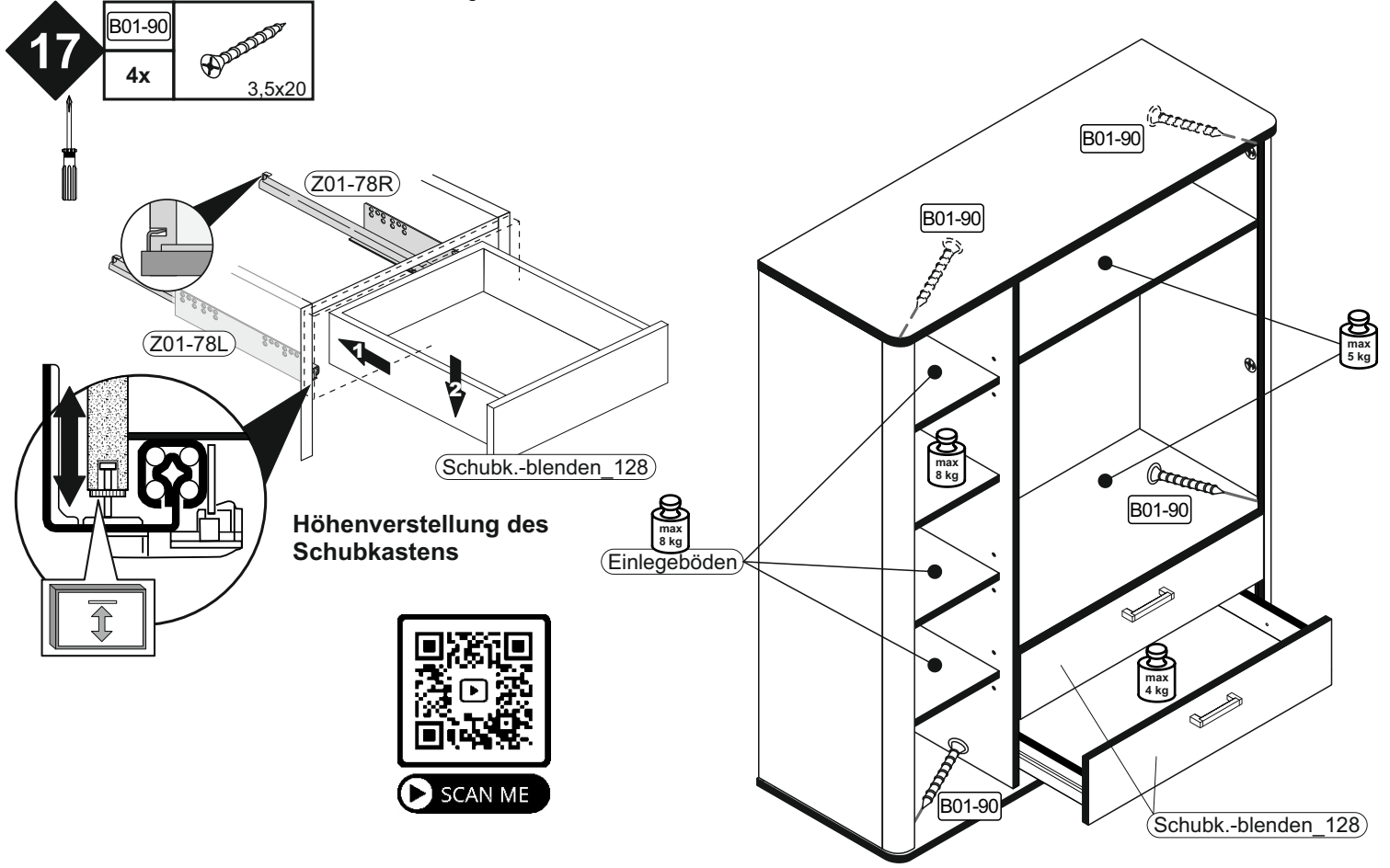
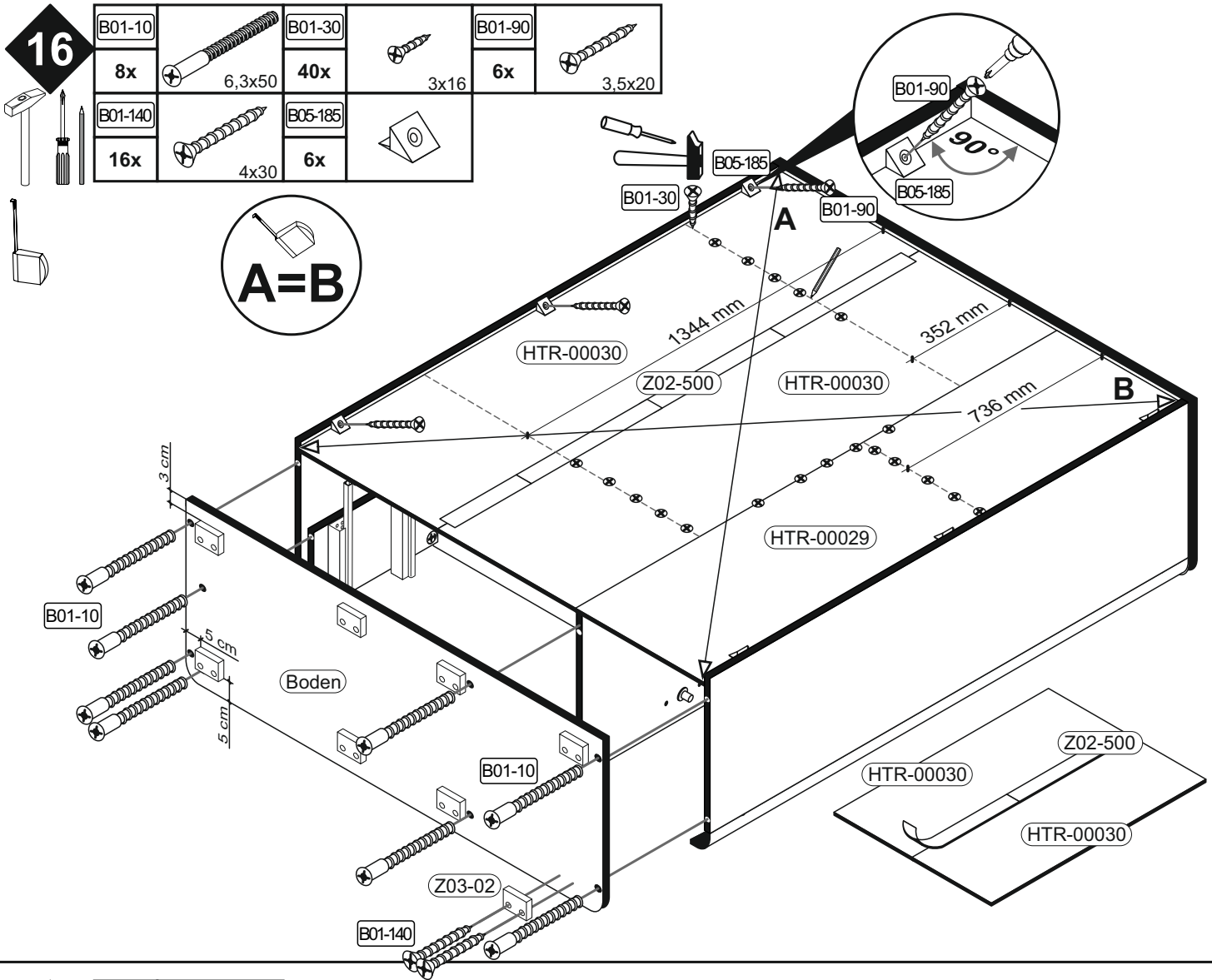

18

B01-140		B03-07		B03-25		B06-312		B08-80	
6x	4x30	3x		6x		3x	128 mm	1x	



## Montage der Tüрдämpfung

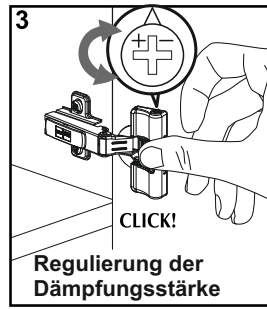
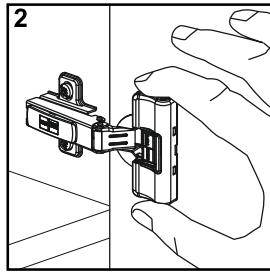
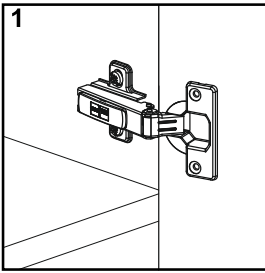

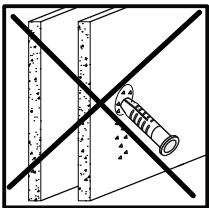
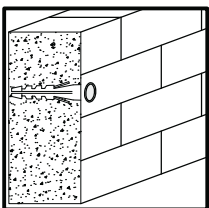
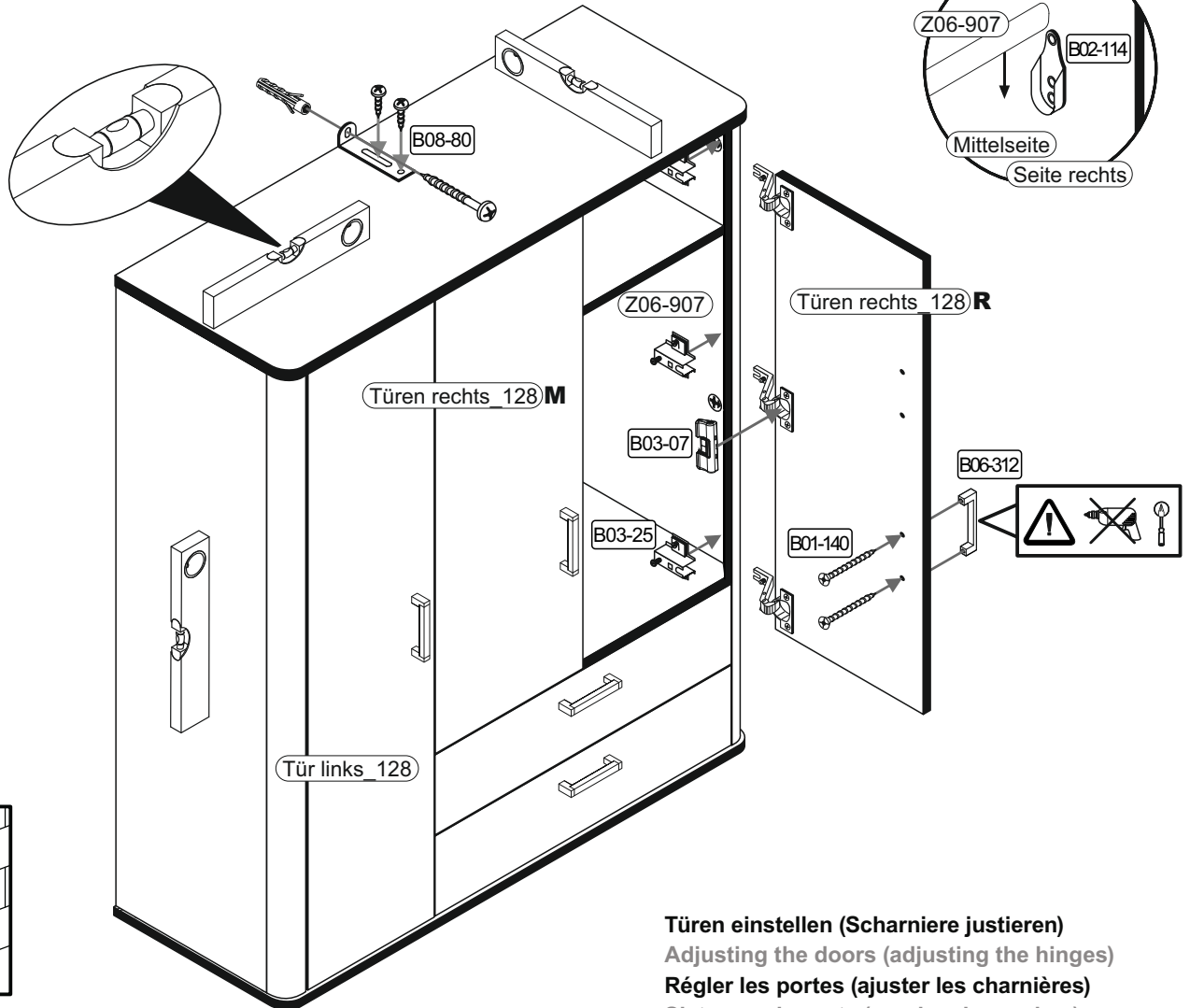

▶ SCAN ME

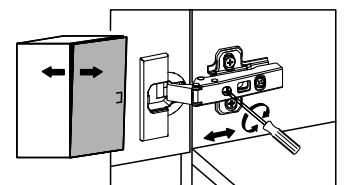
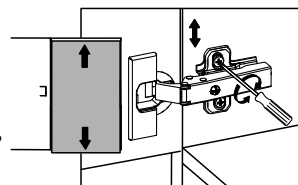
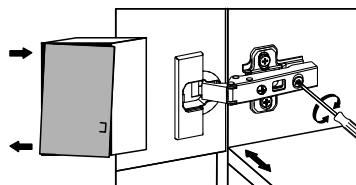
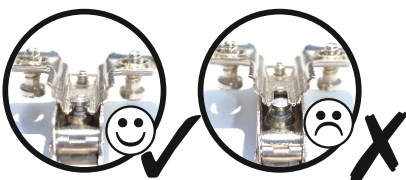

- Türen einstellen (Scharniere justieren)**
- Adjusting the doors (adjusting the hinges)**
- Régler les portes (ajuster les charnières)**
- Sistemare le porte (regolare le cerniere)**
- Deuren instellen (scharnieren afstellen)**
- Nastawić drzwi (wyregulować zawiasy)**
- Vyrovnejte dvířka (seřid'te závěsy)**
- Nastavenie dverí (nastavenie závesov)**
- Állítsa be az ajtókat (állítsa be a zsanérokat)**
- Reglare uși (ajustare balamale)**
- Kapıların ayarlanması (mentşelerin seviye ayarı)**
- Регулировка дверей (регулировка шарнира)**





 <b>Achtung • Attention • Attenzione • Opgelet • Uwaga • Pozor • Figyelem • Atenție • Dikkat • Внимание</b> 	
(D)	Wandbefestigung dient als Kippschutz - unbedingt anbringen! Bei einigen Wandtypen kann ein Spezialdübel erforderlich sein!
(GB)	The wall fastening serves to prevent tipping - be absolutely sure to mount it! For certain wall types, a special wall plug may be necessary!
(FR)	La fixation murale sert de protection contre le basculement – à installer impérativement ! Pour certains types de murs il faut des chevilles spéciales !
(TR)	Duvardaki sabitleme, devrilmeye karşı bir emniyet tedbiridir ve mutlaka monte edilmelidir! Bazı duvar tiplerinde bunun için özel bir dübel gerekli olabilir!
(IT)	Il fissaggio alla parete serve da protezione anti-ribaltamento – attaccarla assolutamente! Per alcune strutture di parete può essere necessario un tassello speciale!
(NL)	Bevestiging aan de muur dient als kantelbescherming – zeker en vast bevestigen! Bij enkele muurtypes is een speciale plug misschien vereist!
(RU)	Обязательно установите крепление на стене во избежание опрокидывания! Для некоторых типов стен может потребоваться специальный дюбель!
(CZ)	Montáž na stěnu slouží jako ochrana proti převrnutí – bezpodmínečně umístěte! U některých typů stěn může být zapotřebí speciální hmoždinka!
(HU)	A terméket a falhoz kel rögzíteni, különben az felborulhat! Egyes faltípusoknál speciális tiplit kell használni!
(RO)	Sistemul de fixare la perete servește ca protecție la răsturnare - de montat obligatoriu! Pentru unele tipuri de perți este posibil să fie necesar un diblu special!
(PL)	Mocowanie do ściany jest jednocześnie zabezpieczeniem przed przewróceniem – koniecznie zamontować! Do niektórych rodzajów ścian koniecznie zastosować specjalne kołki mocujące.
(SK)	Upevnenie na stenu slúži ako ochrana proti prevráteniu – bezpodmienečne použite! Pre niektoré druhy stien môže byť potrebná špeciálna hmoždinka!