

## MONTAGEANLEITUNG / SERVICEKARTE

MONTAGEANLEITUNG SOLLTE NICHT ALS TECHNISCHE DOKUMENTATION BETRACHTET WERDEN. AUFBAUANDEUTUNGEN VOM PRODUZENTEN VORBEHALTEN

SEHR GEEHTER KUNDE, SOLLTE EIN TEIL FAHLEN ODER BESCHADIGT SEIN, KREUZEN SIE BITTE DIESES DEUTLICH AUF DER SERVICEKARD AN UND SCHICKEN SIE UNS DIE SERVICEKARD ZURÜCK.

DEN KLEBER BENUTZEN SIE NUR ZUM VERLEIMEN DER SCHUBLADEN.

UM DIE EVENTUELLEN REKLAS RICHTIG ZU ERLEDIGEN, BITTEN WIR UM EINE KOPIE DES AUFKLEBERS VON DER WARE, ODER UM ANGABE DER PRODUKTIONSWOCHE.

TEILNUMMER	TEILBEZEICHNUNG	MENGE	ZEIT
①	864x350x16	1	2/2
②	864x350x16	1	2/2
③	864x350x16	1	2/2
④	804x350x16	1	2/2
⑤	736x350x16	1	1/2
⑥	736x350x16	1	1/2
⑦	1520x353x16	1	1/2
⑧	1521x60x16	1	1/2
⑨	1521x60x16	1	1/2
⑩	759x60x16	1	1/2
⑪	759x60x16	1	1/2
⑫	385x350x16	1	1/2
⑬	736x350x16	1	1/2
⑭	186x346x16	4	2/2
⑮	310x110x16	4	1/2
⑯	310x110x16	4	1/2
⑰	293x84x16	4	1/2
⑱	307x317x3	4	1/2
⑲	754x346x16	1	2/2
⑳	754x346x16	1	2/2
㉑	754x346x16	1	2/2
㉒	405x826x3	2	1/2
㉓	347x826x3	2	1/2

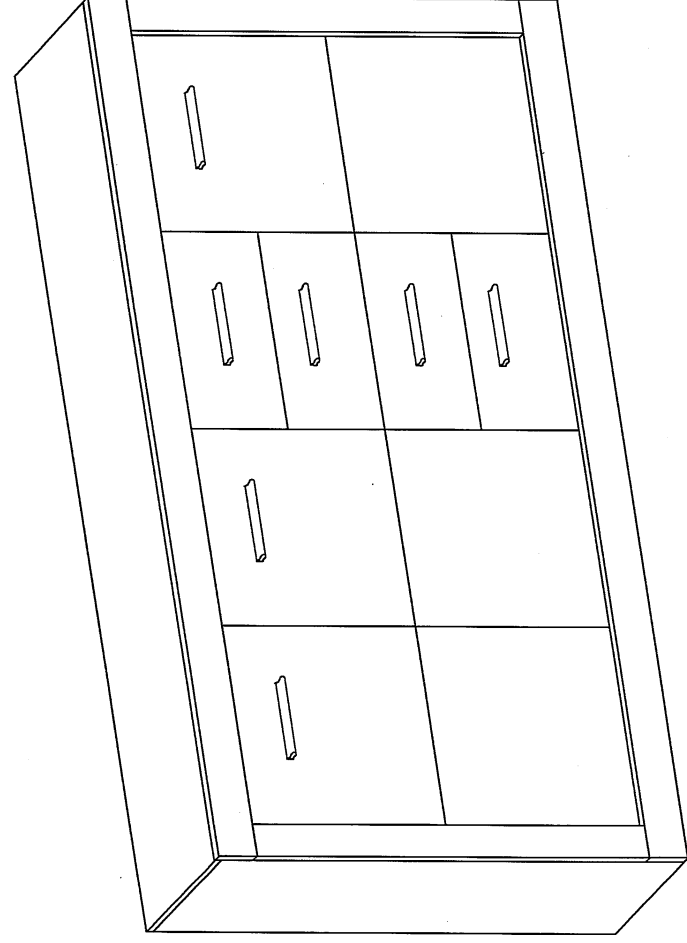

D		H1		J		S1		S		B		W		W1		M		A		A1		N	
	x4		x4		x12		x42		x42		x42		x8		x8		x1		x36		x8		x10
D1		H		O		C		E		K		K1		P		G		F		U			x100
	x2		x2		x1		x4		x16		x7		x14		x8		x8		x6		x6		x100

# CAN CAN Kommode 3

Nr 2/8

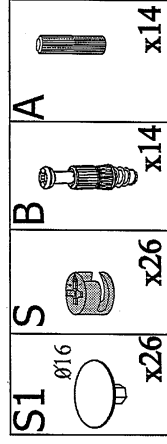
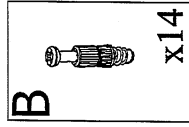
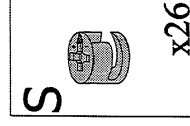
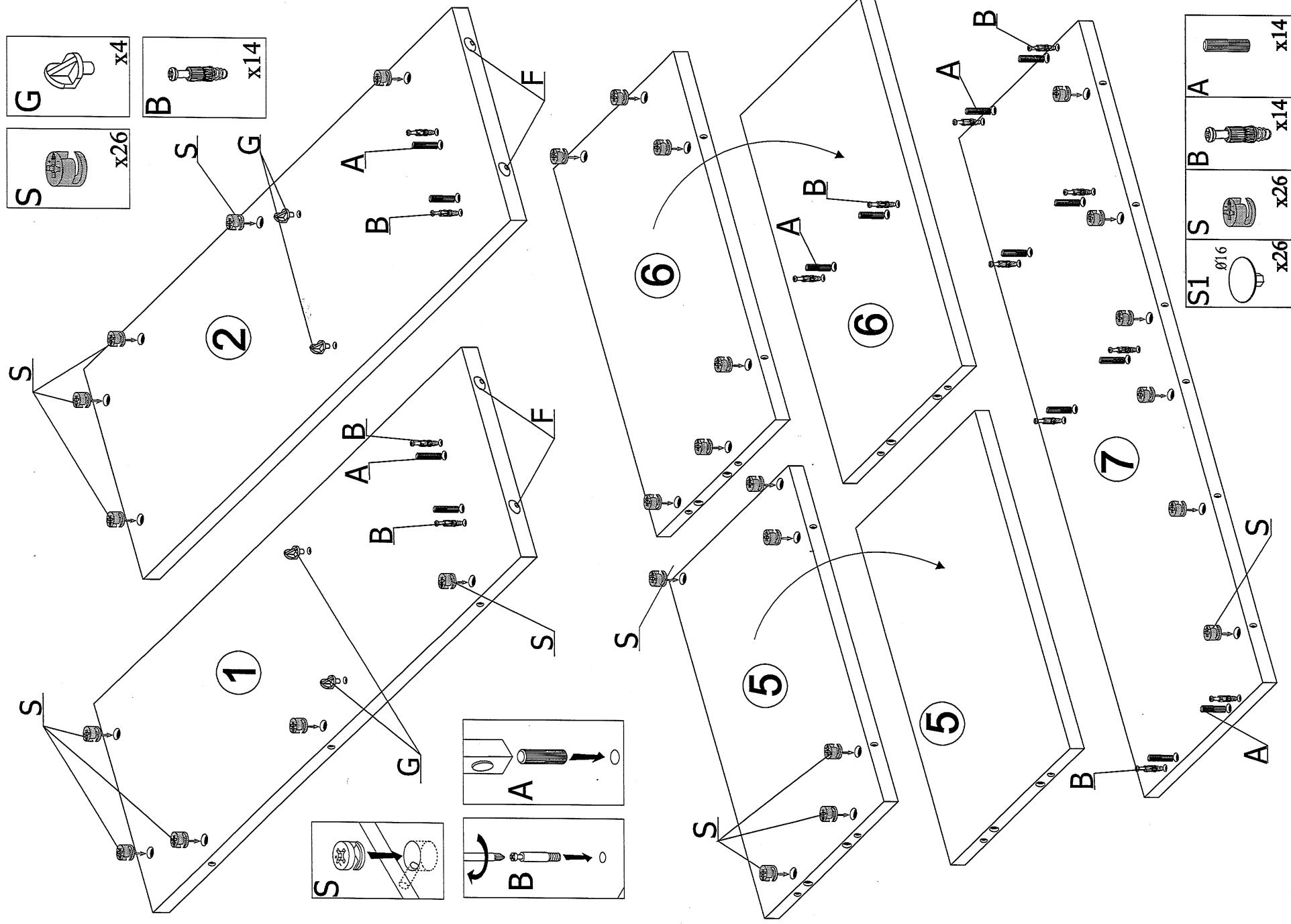

# CAN CAN Kommode 3

Nr 3/8

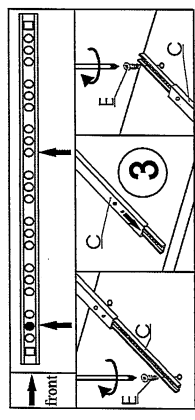
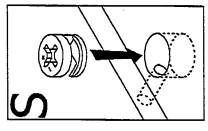
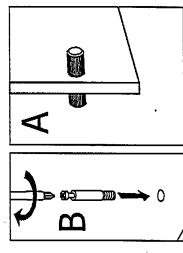
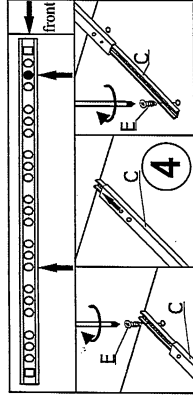
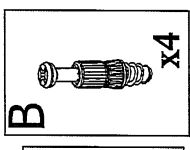
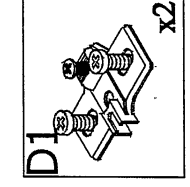
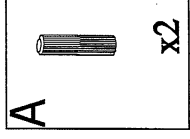
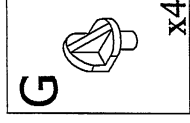
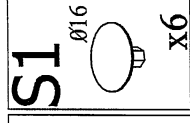
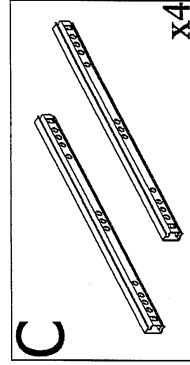
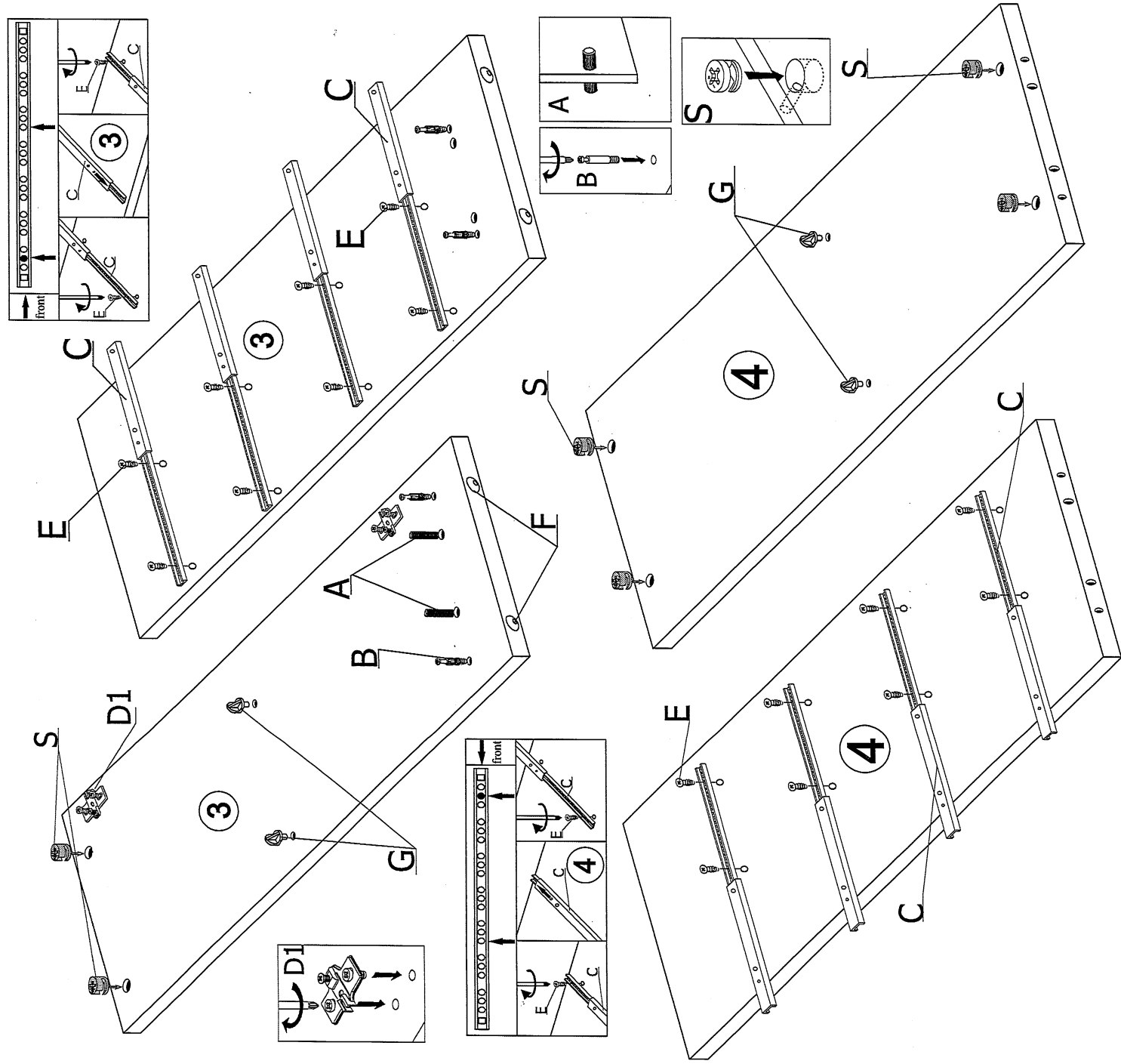

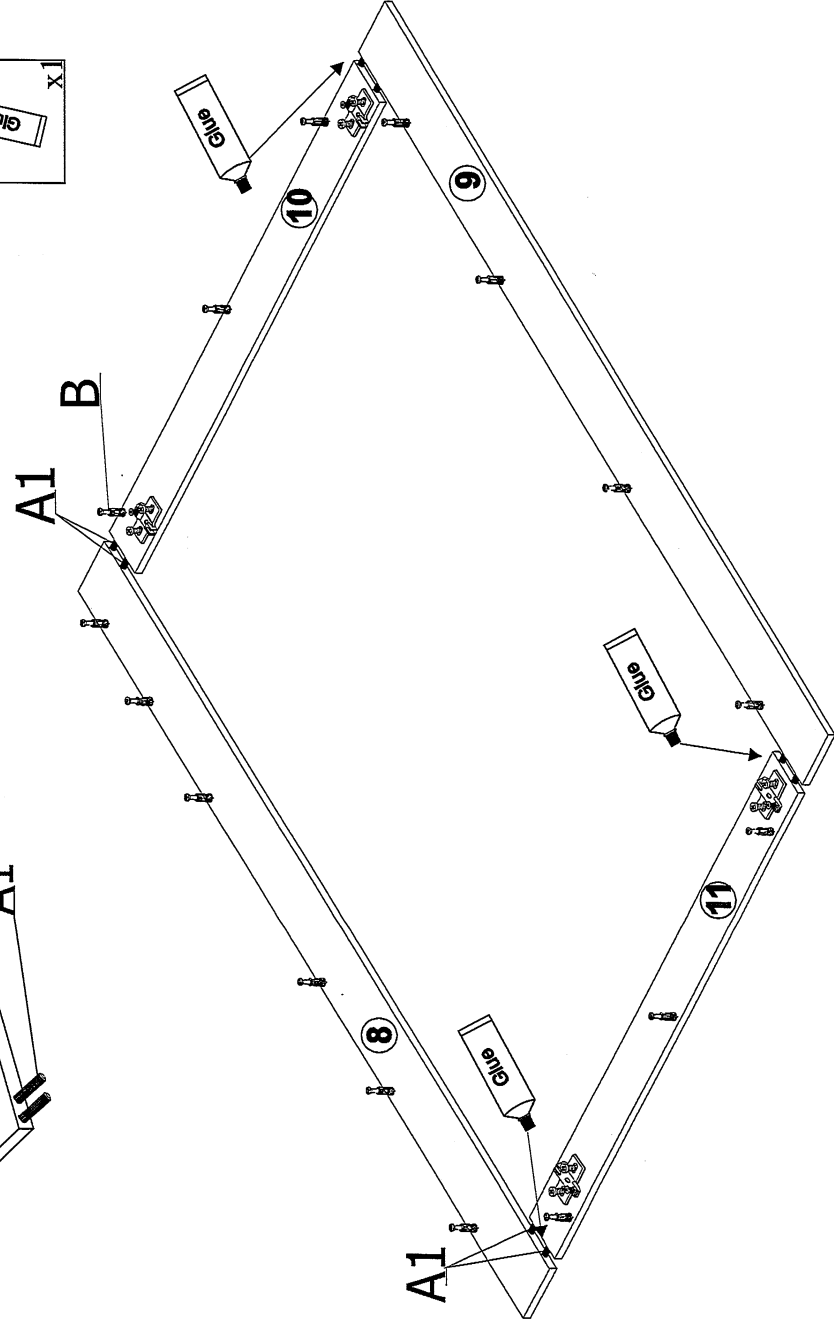
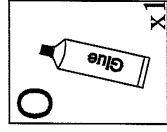
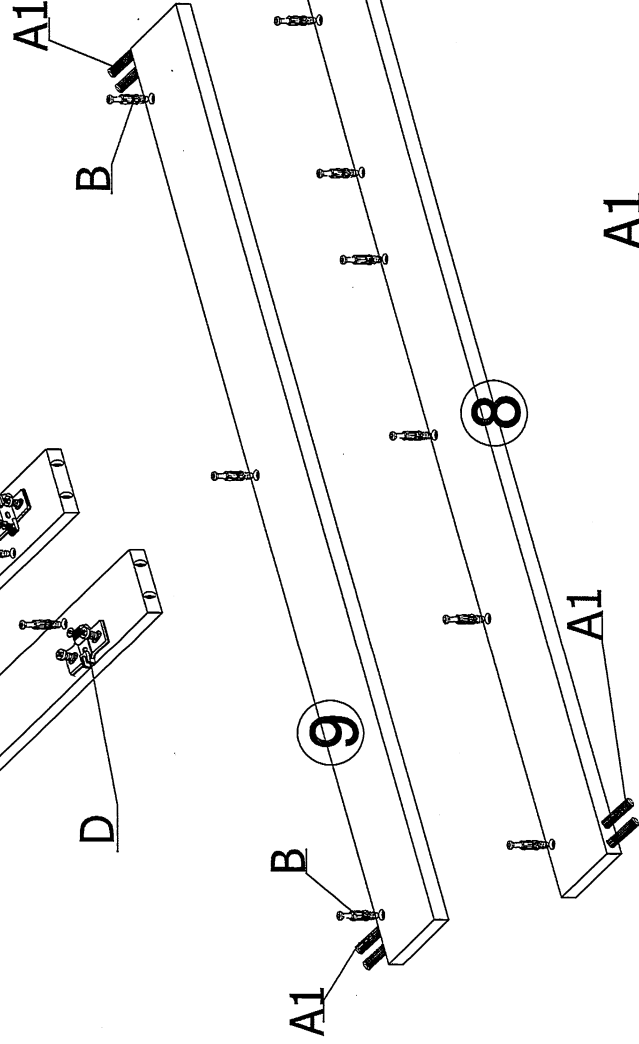
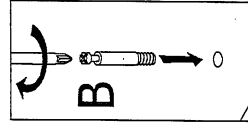
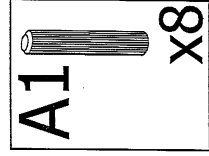
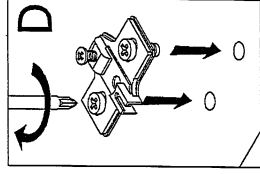
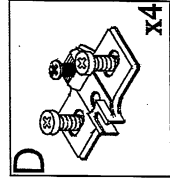
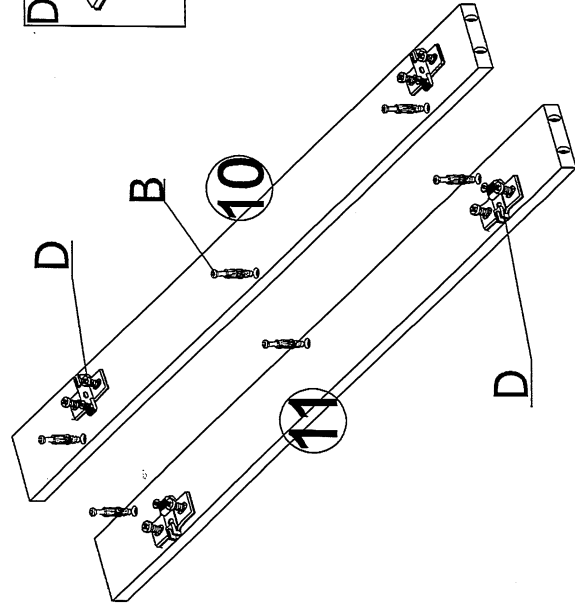

# CAN CAN Kommode 3

Nr 5/8

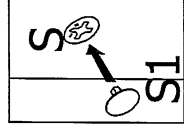
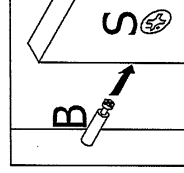
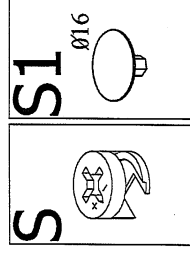
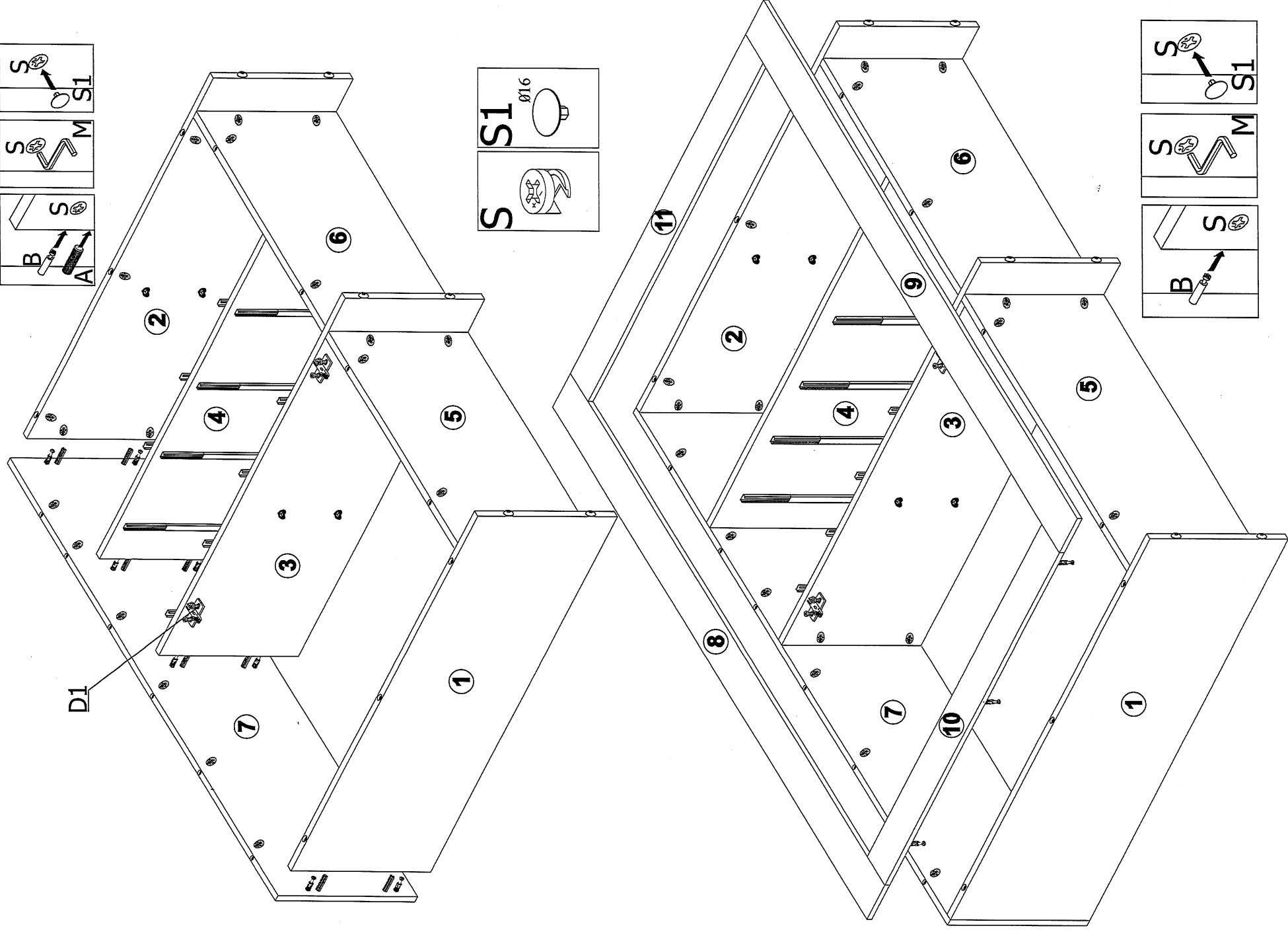
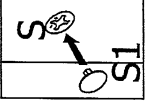
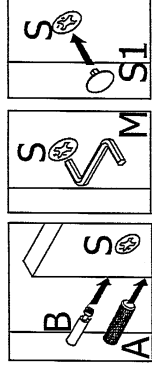



# CAN CAN Kommode 3

Nr 7/8

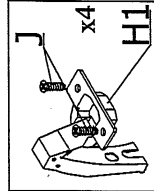
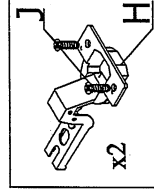
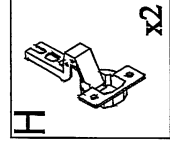
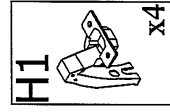
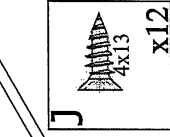
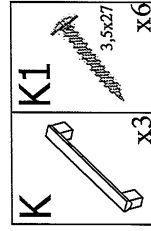
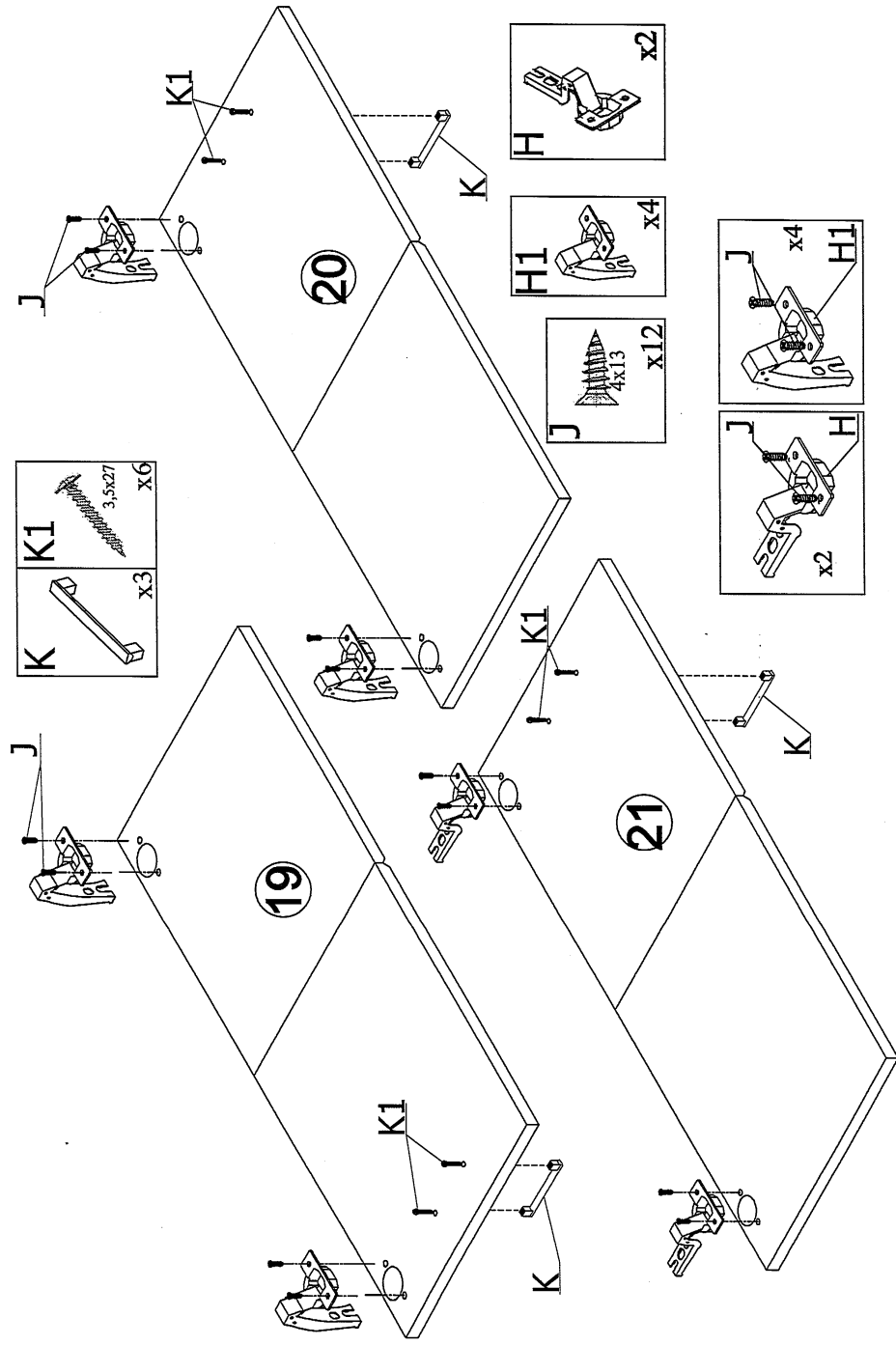
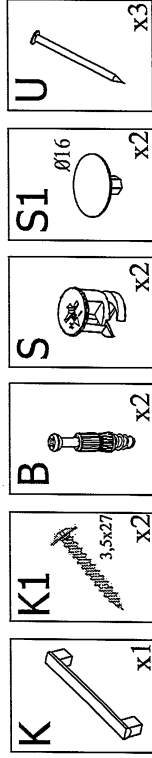
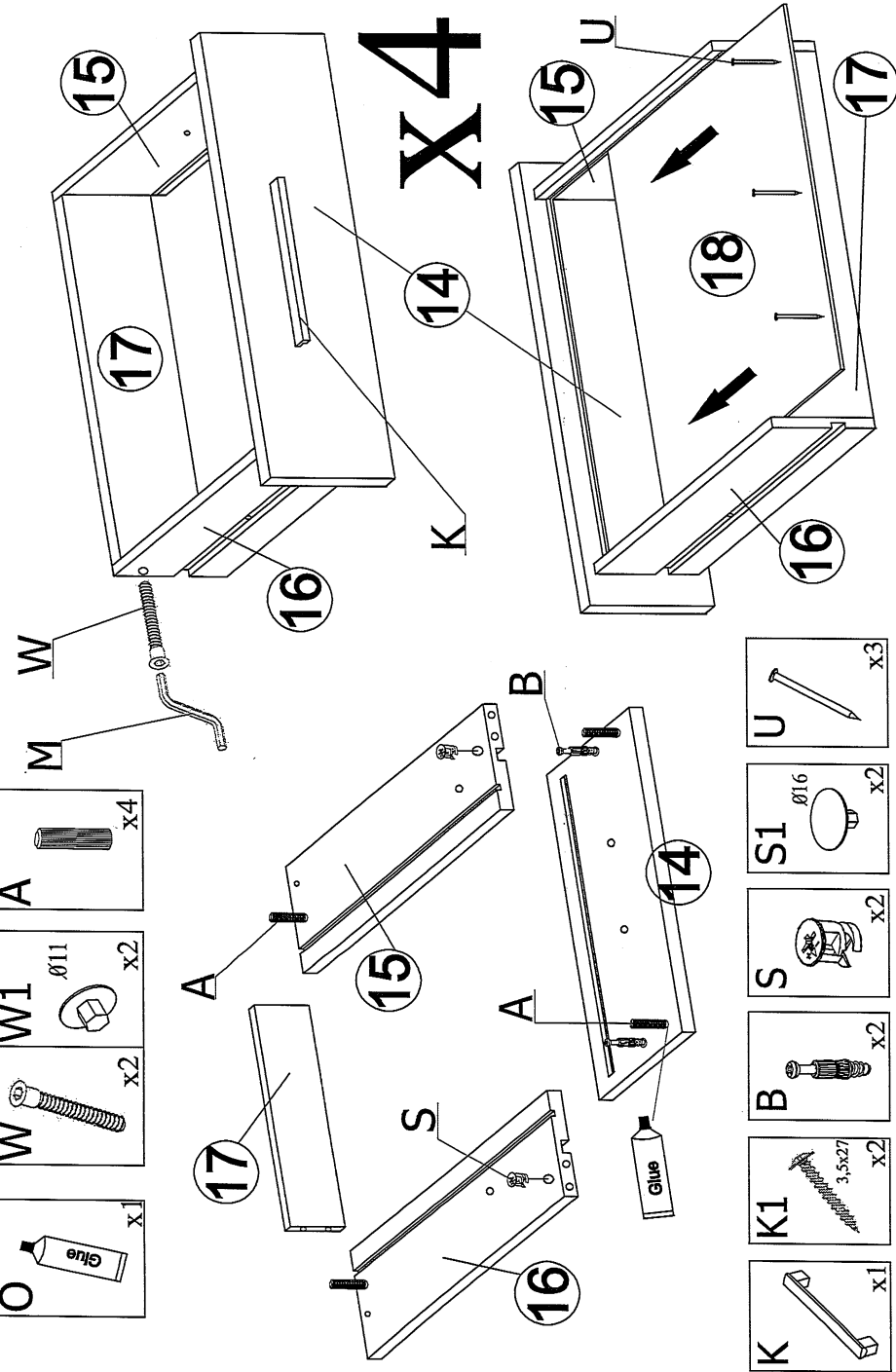
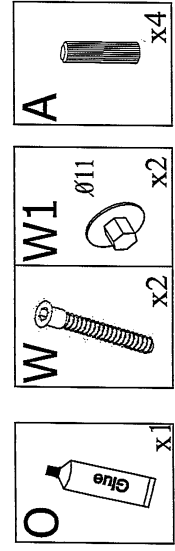

# CAN CAN Kommode 3

Nr 8/8

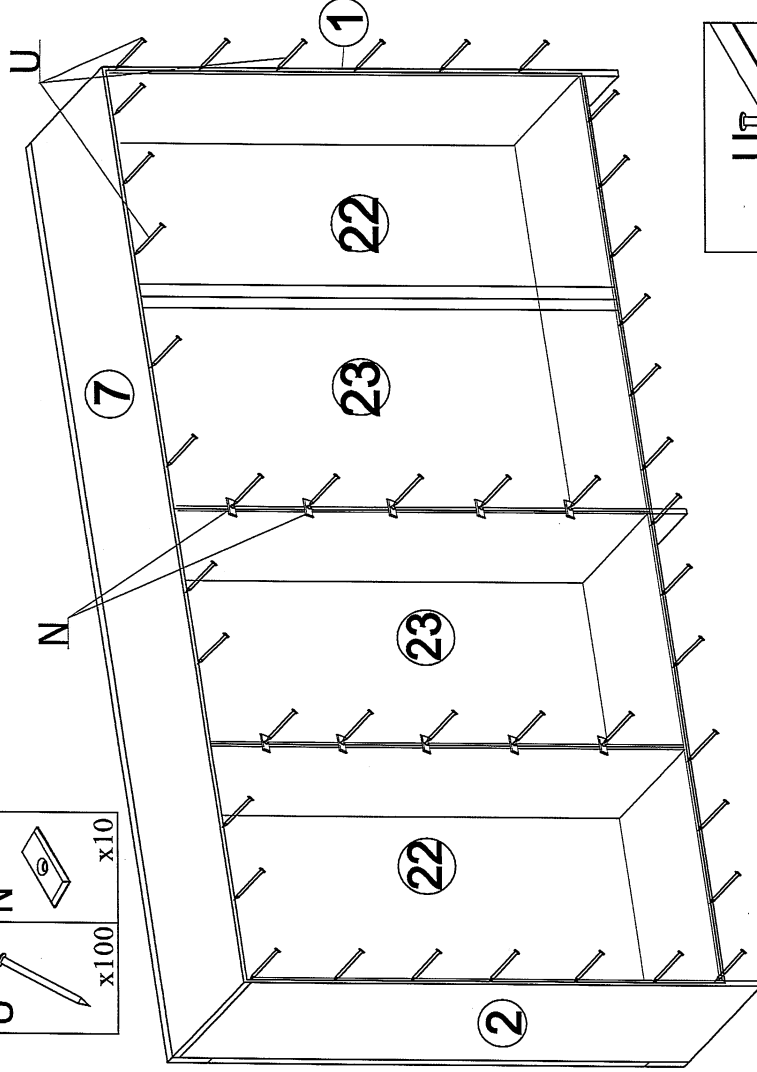
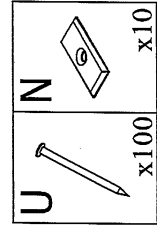

TEILENUMMER	BEZUGSMAß	MENGE	ZEIT
①	864x350x16	1	2/2
②	864x350x16	1	2/2
③	864x350x16	1	2/2
④	804x350x16	1	2/2
⑤	736x350x16	1	1/2
⑥	736x350x16	1	1/2
⑦	1520x353x16	1	1/2
⑧	1521x60x16	1	1/2
⑨	1521x60x16	1	1/2
⑩	759x60x16	1	1/2
⑪	759x60x16	1	1/2
⑫	385x350x16	1	1/2
⑬	736x350x16	1	1/2
⑭	186x346x16	4	2/2
⑮	310x110x16	4	1/2
⑯	310x110x16	4	1/2
⑰	293x84x16	4	1/2
⑱	307x317x3	4	1/2
⑲	754x346x16	1	2/2
⑳	754x346x16	1	2/2
㉑	754x346x16	1	2/2
㉒	405x826x3	2	1/2
㉓	347x826x3	2	1/2

