

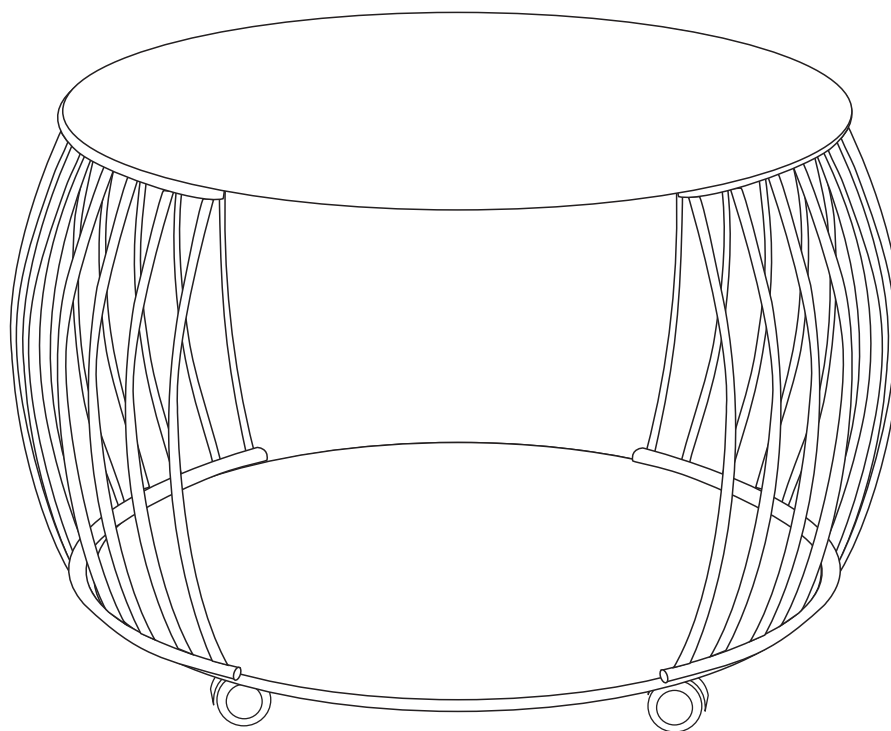

- |           |                             |           |                         |
|-----------|-----------------------------|-----------|-------------------------|
| <b>D</b>  | Montageanleitung            | <b>GB</b> | Assembly instructions   |
| <b>FR</b> | Notice de montage           | <b>IT</b> | Istruzioni di montaggio |
| <b>NL</b> | Handleiding voor de montage | <b>PL</b> | Instrukcja montażu      |
| <b>CZ</b> | Montážní návod              | <b>SK</b> | Návod na montáž         |
| <b>HU</b> | Szerelési útmutató          | <b>RO</b> | Instrucțiuni de montaj  |
| <b>TR</b> | Montaj talimatı             | <b>RU</b> | ИНСТРУКЦИЯ ПО МОНТАЖУ   |

## 3435.77 Macau 2







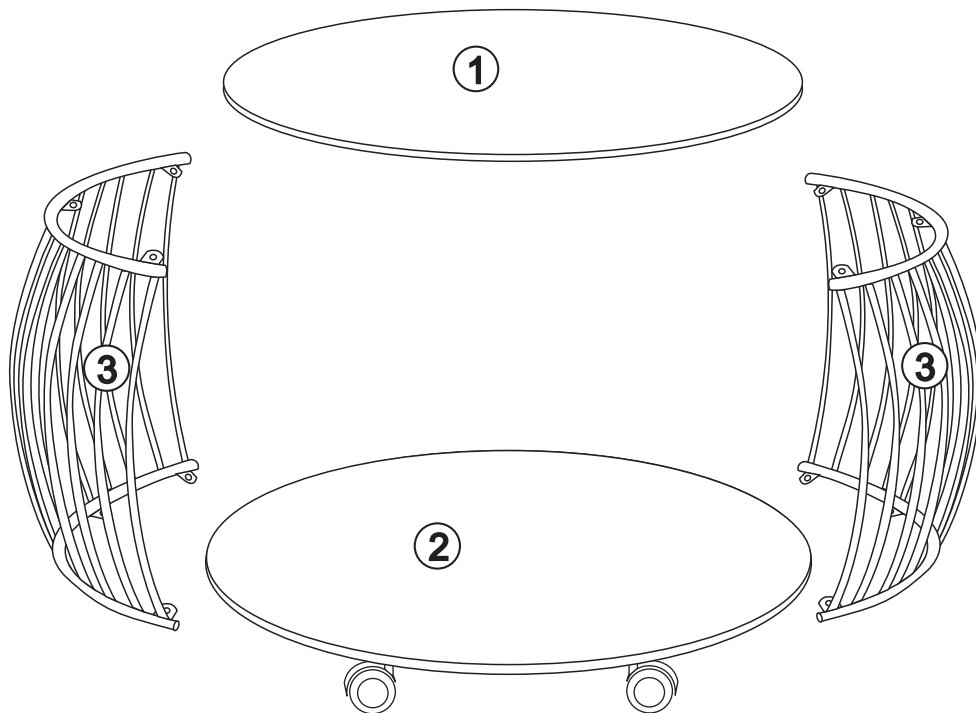
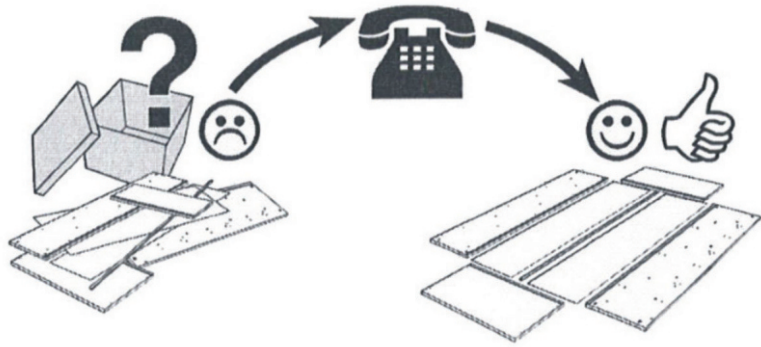
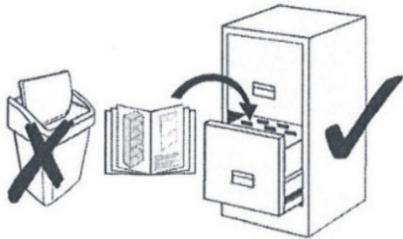



**Service • Assistenza • Dienstverlening • Serwis  
Servis • Szerviz • Сервисная служба**

Name • Nom • Nome • Naam Nazwa • Jméno • Názov • Név Denúire • İsim • Название	
Nr. • No. • N° • Номер • Č • Sz	
Тур • Туре • Тір • Тípus • Тíро Тип	
	



- 1x ①
- 1x ②
- 2x ③

<b>A</b>  X6	<b>B</b>  X18	<b>C</b>  X1	<b>D</b>  X16	<b>E</b>  X4	<b>F</b>  X1	<b>G</b>  X6	<b>H</b>  X6	<b>I</b>  X1
---	--	---	--	---	---	--	---	---

A

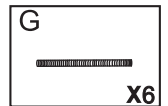
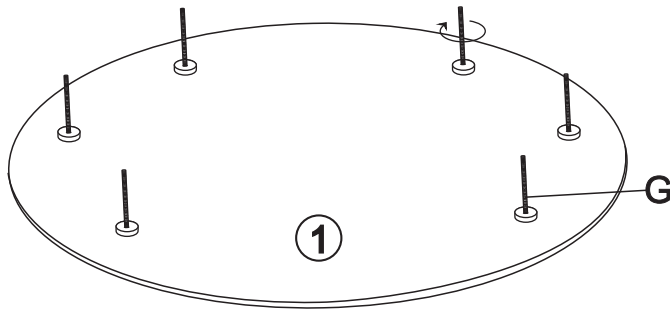
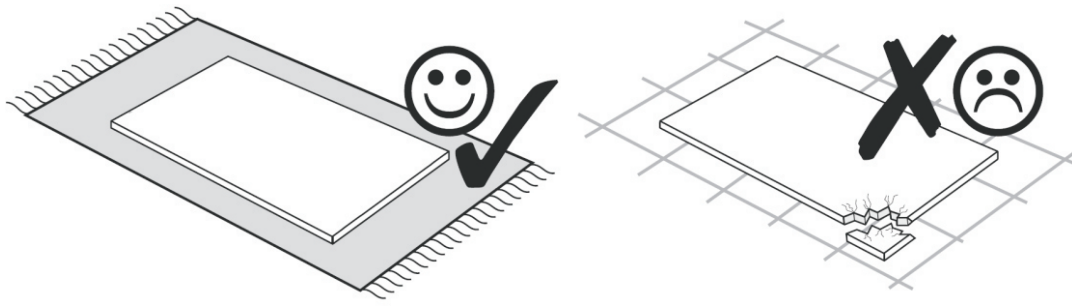

B

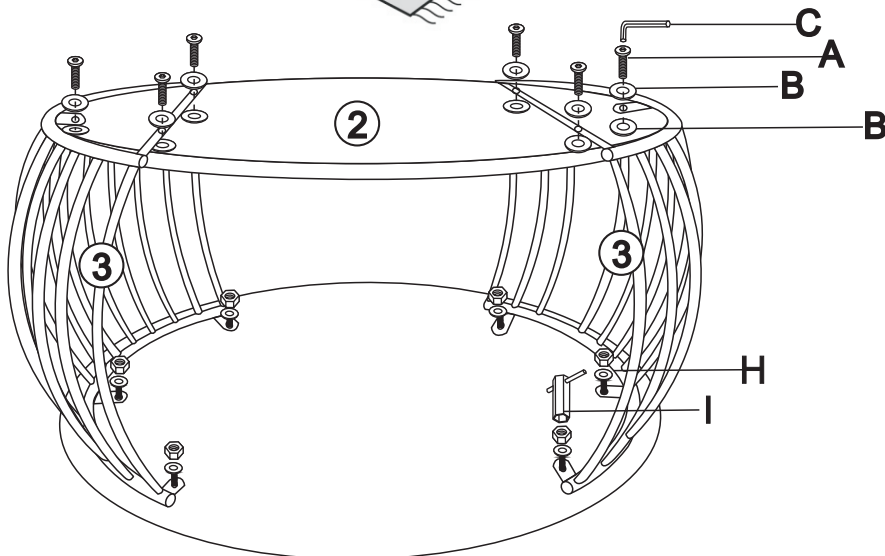
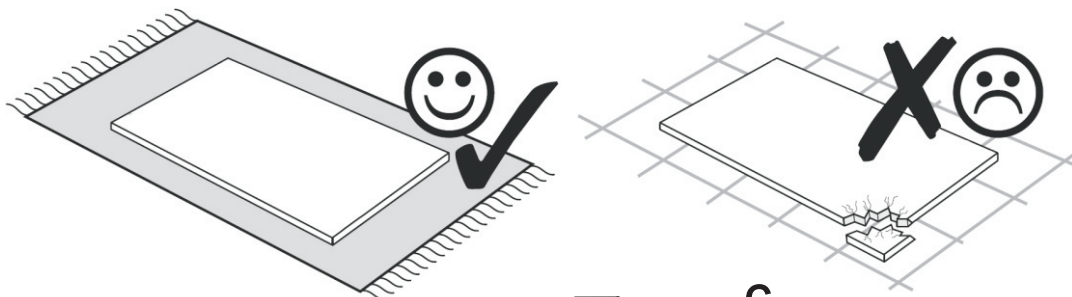

Achtung:  
 Bitte Schraube A vorsichtig von Hand eindrehen.  
 Bitte keinen Akkuschauber benutzen.  
 Please screw in part A by hand.  
 Please do not use a cordless drill.

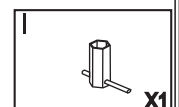
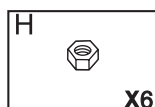
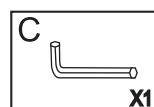
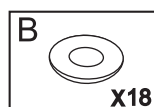
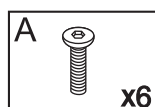

C

