

# Mars

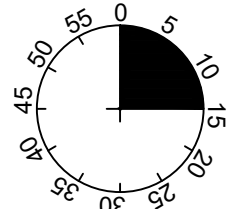
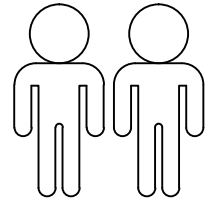
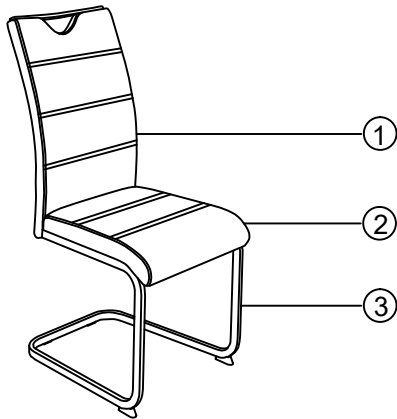

1

2

3

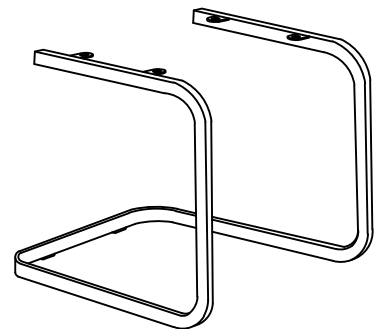
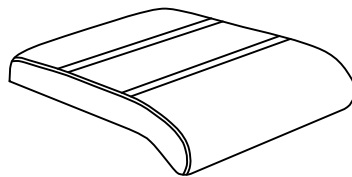
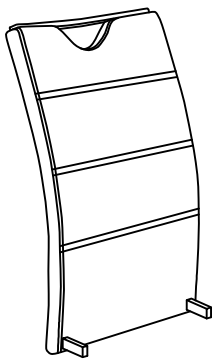

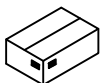

1	1x
2	1x
3	1x





1/1

**A** M6X20  
  
 4x

**B** M6X12  
  
 4x

**C** Ø18xØ6x1.5  
  
 4x

**D** 4MM  
  
 1x

**E** M4x25  
  
 4x

**F**  
  
 2x

**I.**

**1**

E M4x25  
4x

F  
2x

100%

**2**

B M6x12  
4x

D 4MM  
1x

75%

**3**

A M6X20  
4x

C Ø18xØ6x1.5  
4x

D 4MM  
1x

75%

**4**

D 4MM  
1x

100%



Séparez les éléments avant de trier