

# Elif

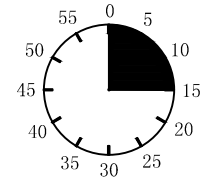
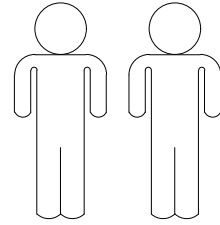
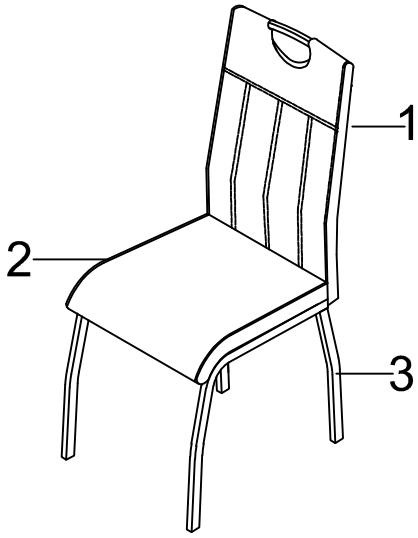

1

2

3

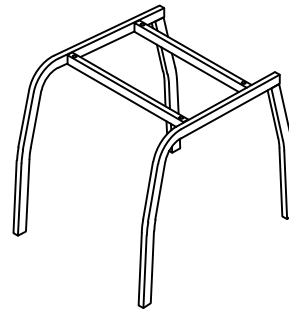
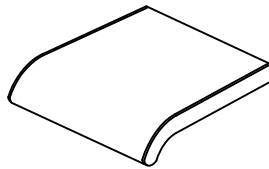
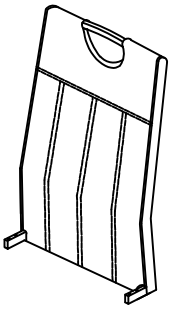



1	1X
2	1X
3	1X

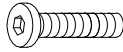

1/1

<b>A</b>	M6*12
	4X

<b>B</b>	M6*40
	4X

<b>C</b>	Ø16*Ø6.5*1.5
	4X

<b>D</b>	4mm
	1X

I.

1.

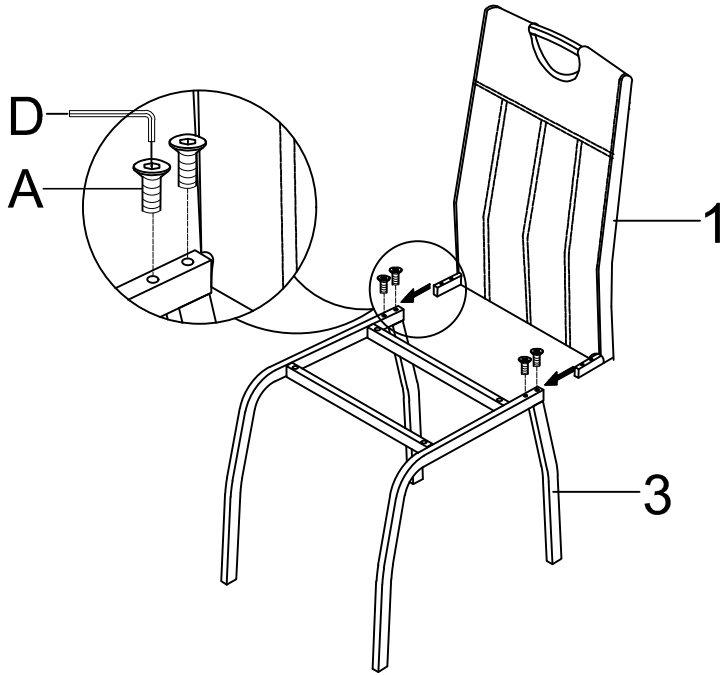

A

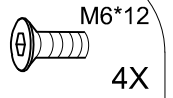

D

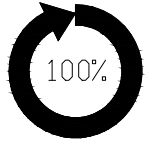
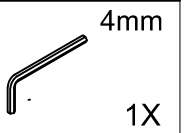

2.

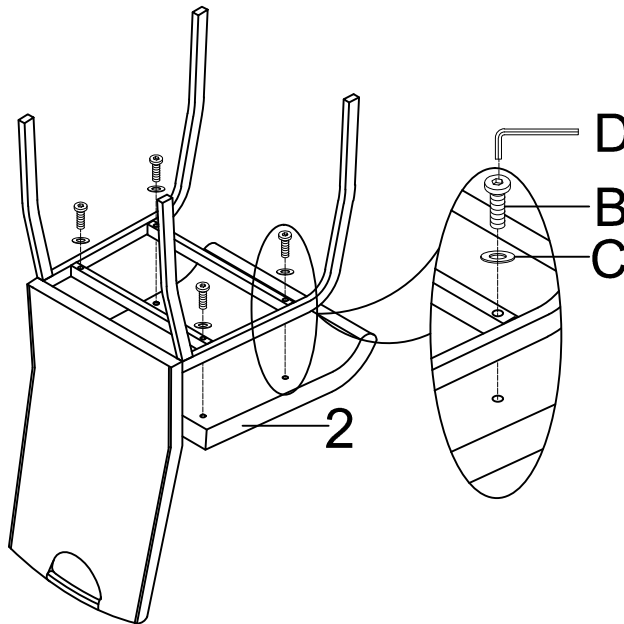

B

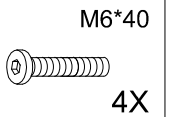

C

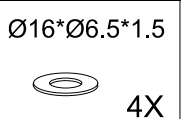

D

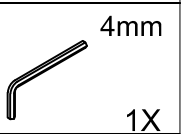

3.

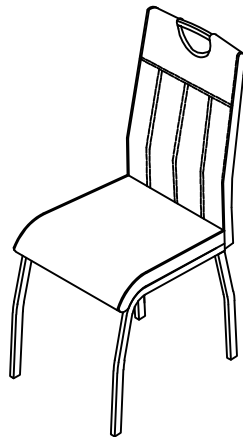

D

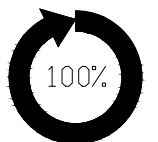
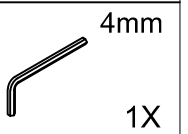

LE TRI  
+ FACILE



Séparez les éléments avant de trier