

LED 22 W
2.600 lm
28 W
1.550 lm
t 25.000 h
T_k 2.700 - 5.000 K
15.000 x
<0,5 s



LED 5 W
460 lm
28 W
1.550 lm
t 25.000 h
T_k 5.000 K / RGB
15.000 x
<0,5 s



996755

230V / 50Hz~

1x LED-Board 24V DC / 22 W

1x LED-Board 24V DC / 5 W

2,4 GHz
6 dBm

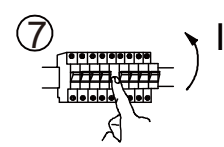
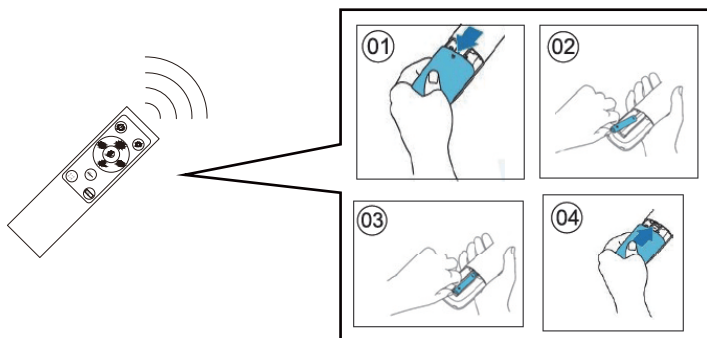
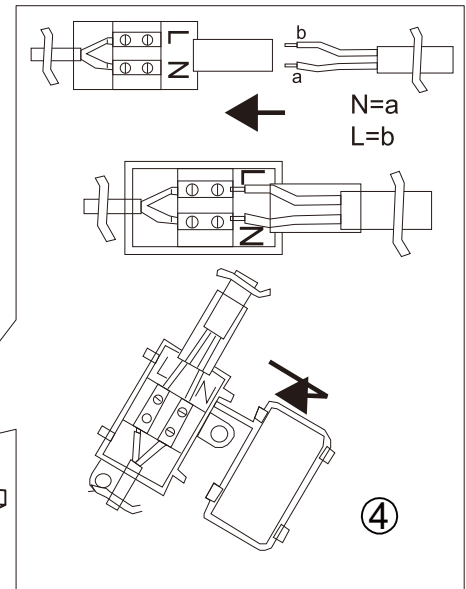
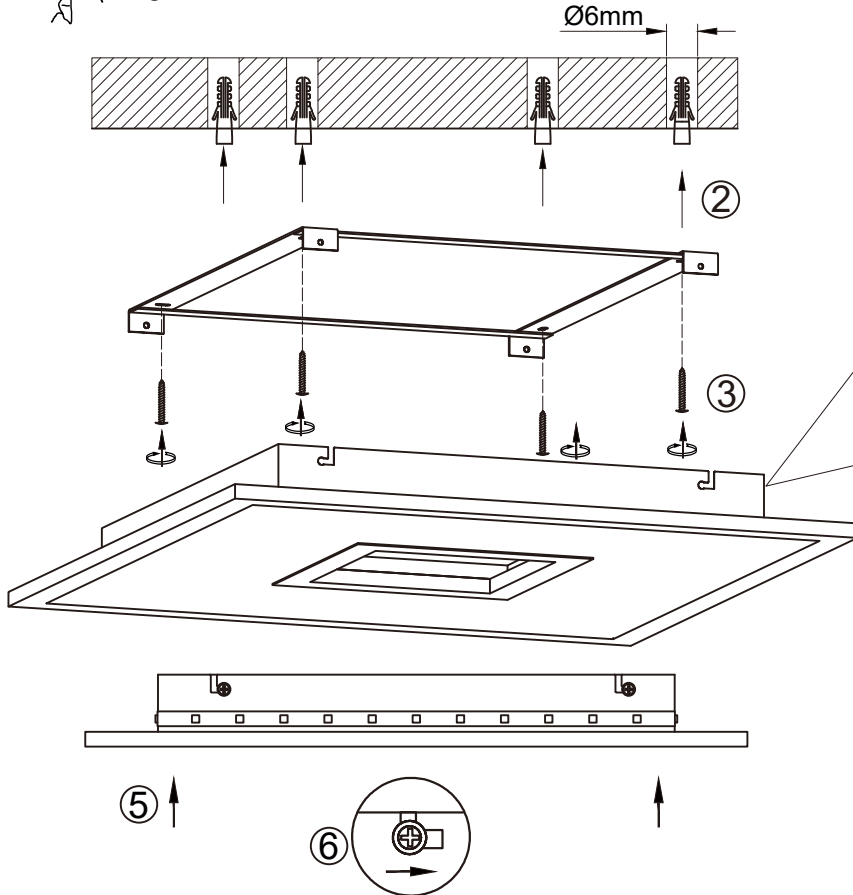
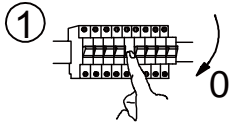
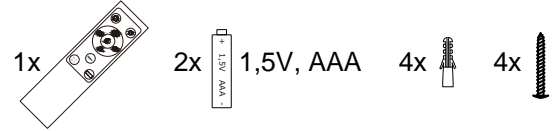

Das Gerät erfüllt die grundlegenden Anforderungen der Richtlinie 2014/53/EU (Radio Equipment Directive) des Europäischen Parlaments und des Rates der europäischen Union vom 16.04.2014 über Funkanlagen.
Die vollständige Konformitätserklärung kann bei der unten stehenden Internet-Adresse aufgerufen werden.

This device fulfils the fundamental requirements of Directive 2014/53/EU (Radio Equipment Directive) of the European Parliament and of the Council of the European Union dated 16.04.2014 on items of radio equipment.
The full declaration of conformity can be accessed at the Internet-address given below.

Leuchten**Direkt**

LeuchtenDirekt GmbH
Olakenweg 36 · 59457 Werl
Germany
E-mail : kundenservice@neuhaus-group.de
<https://scm.paul-neuhaus.de/public/conformity/>