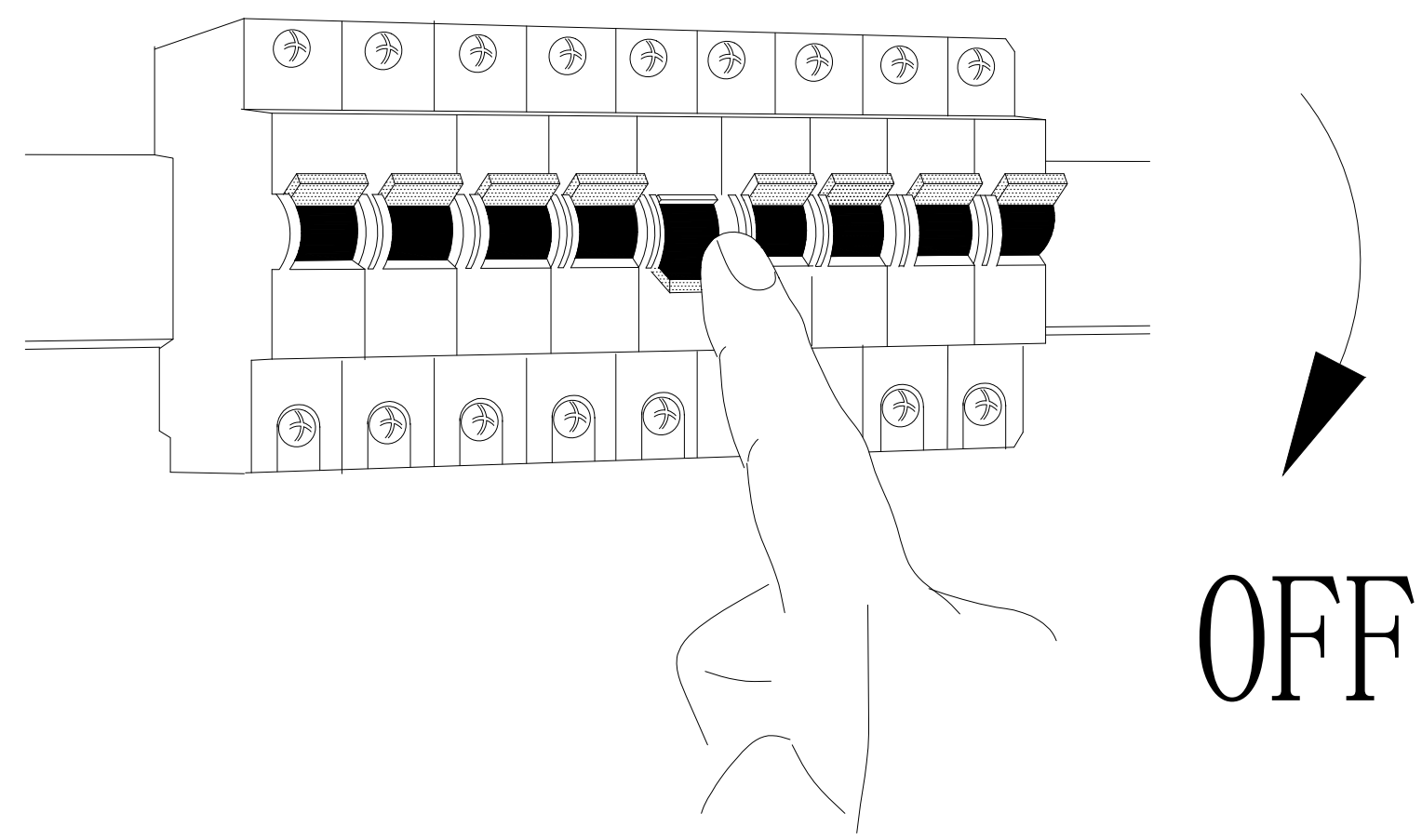
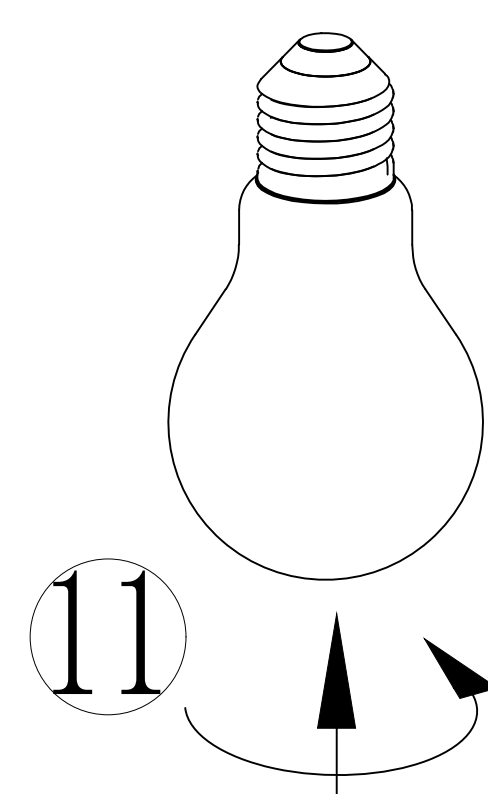
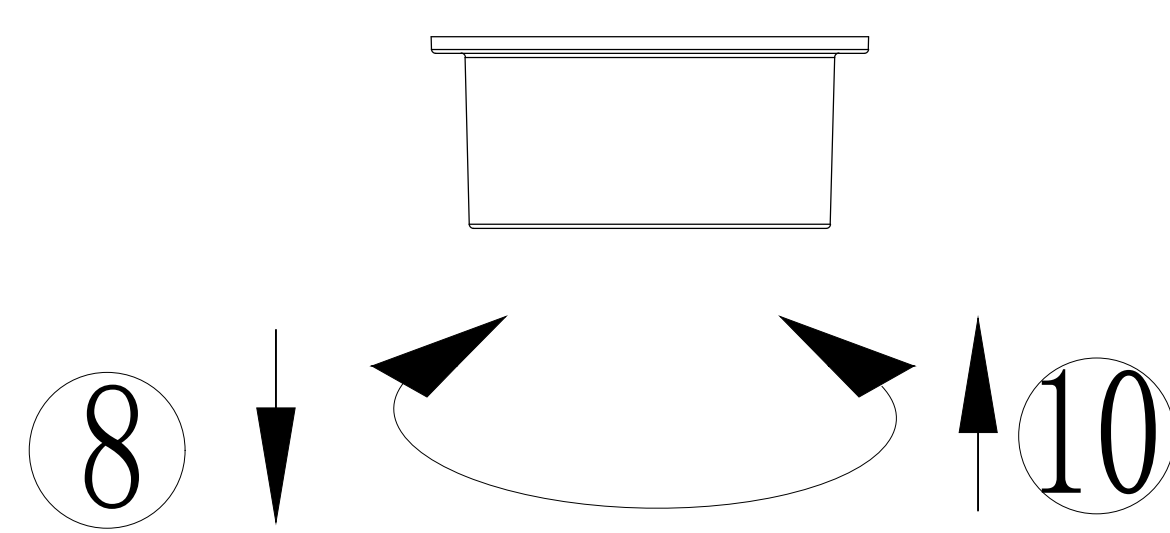
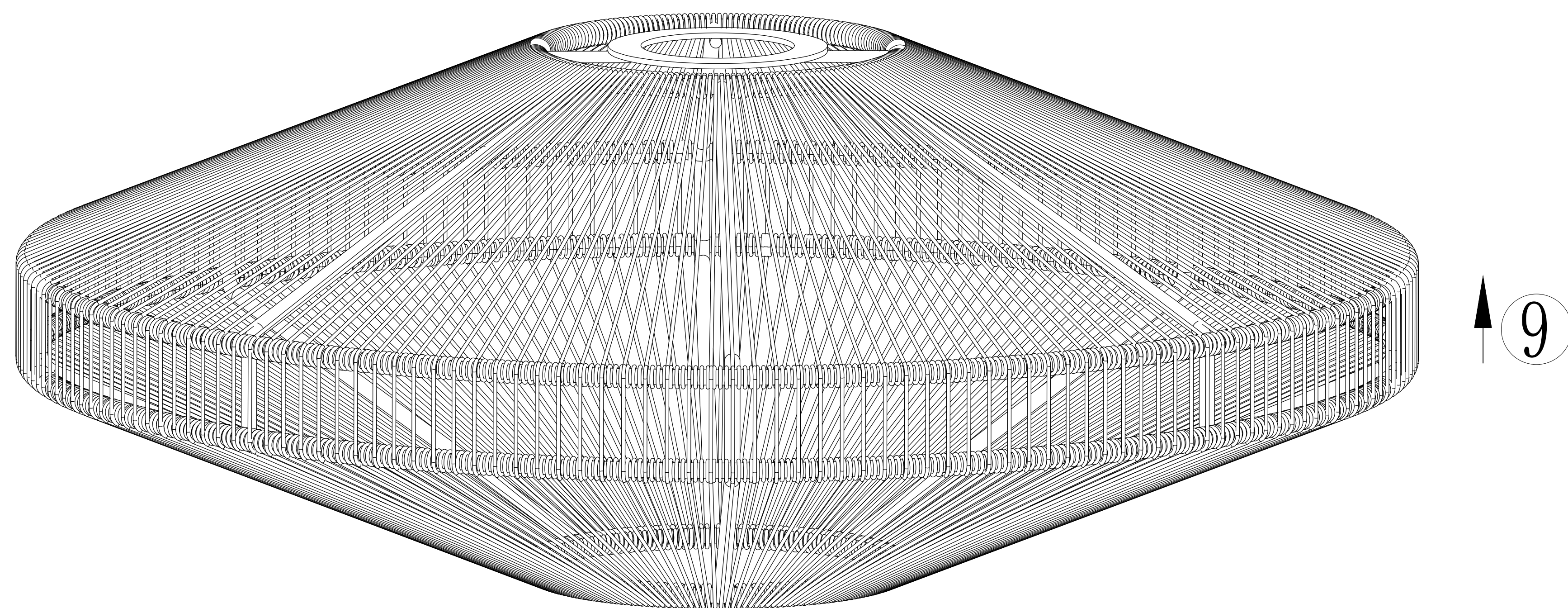
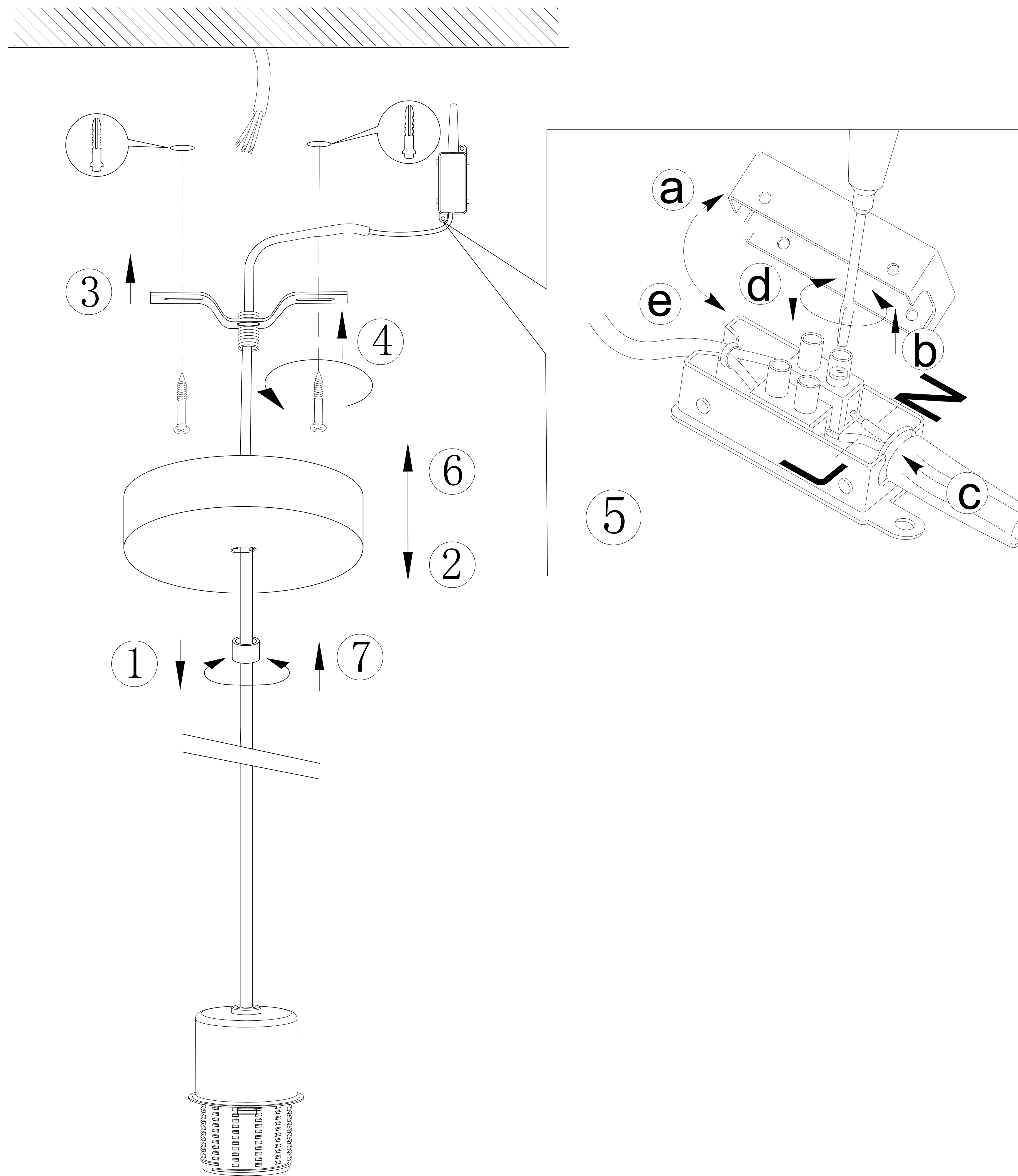
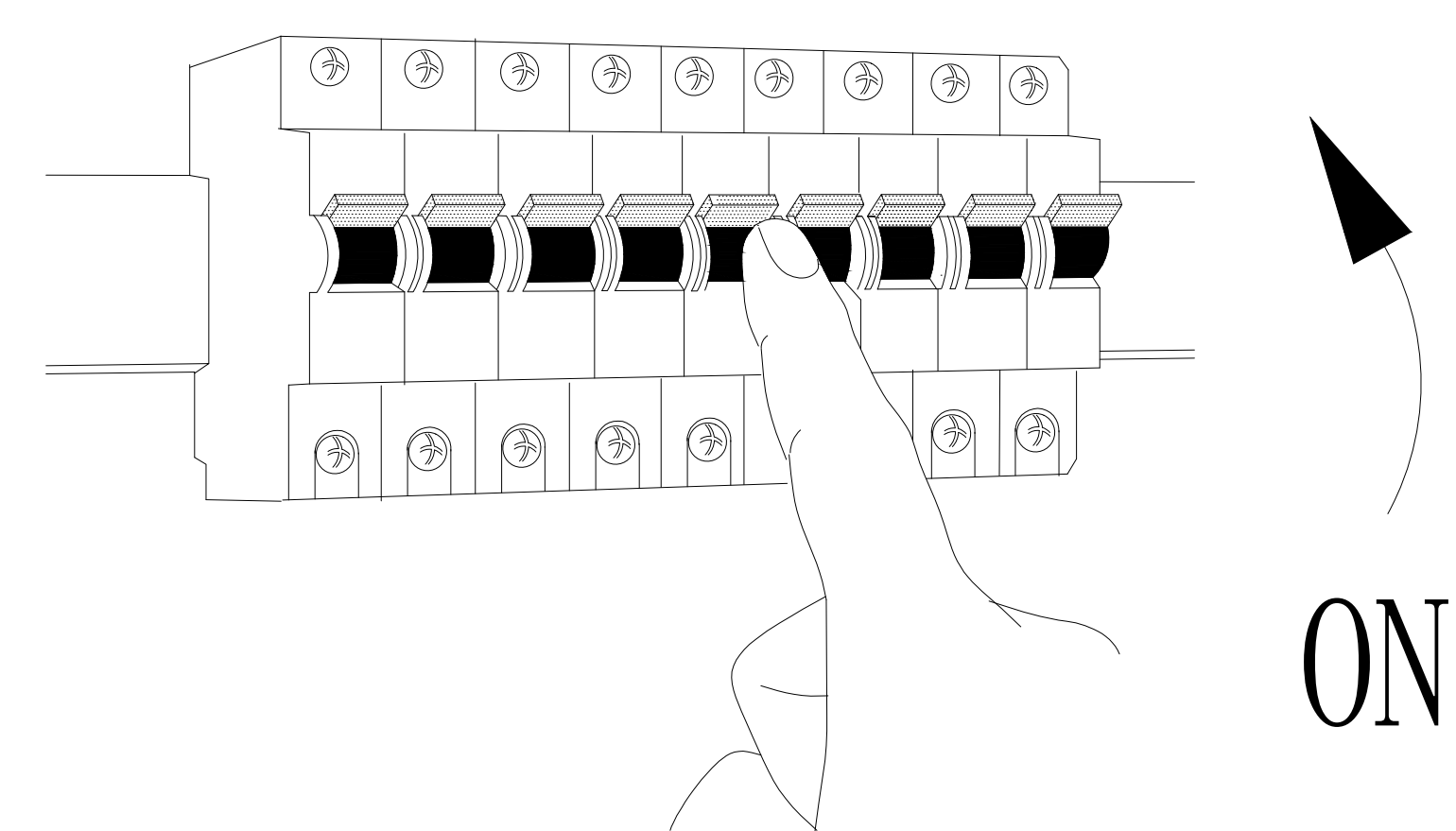

A**B****C**

B43999
www.eglo.com